

Radbefestigung
Wheel Fastening
Fixation de roue
Fijación de las ruedas
Fissaggio ruota

- Mehr als 340 Teile.
- More than 340 parts.
- Plus que 340 pièces.
- Más que 340 piezas.
- Più che 340 prodotti.



bilstein group	I	Kugelbundmuttern · Spherical collar nuts	60 - 64
Unternehmen · Company	II	Sechskantmuttern · Hex. nuts	65 - 68
Eigenfertigung · In-house production	IV	Konusmuttern · Conical nuts	69
Katalogleitfaden · Catalogue guide	VI	Zentrierringe · Spherical rings	70 - 71
Radbefestigung · Wheel fastening	X	Limesringe · Galvanized circlips	72 - 73
Unser Portfolio · Our portfolio	XIV	Hülsen · Sleeves	74
		Flachrundschrauben · Cup head bolts	75 - 76
		Hammerkopfschrauben · T-screw	77 - 78
Radschrauben LCV · Wheel screws LCV	1 - 11	Zubehör passend für Triles · Accessories to fit Trilex	79 - 80
Radbolzen · Wheel bolt	12 - 38	Zuordnungsliste Radbolzen + Zubehör · Mapping list wheel bolt + accessories	81 - 88
Radbolzen mit Mittelbund · Central union bolt	39 - 41	Zuordnungsliste Trilex + Zubehör · Mapping list Trilex + accessories	89
Muttern mit Druckteller · Nut with thrust plate	42 - 47	Ref.-Nr. > febi Nr. · Ref. number > febi number	90 - 106
Muttern für Druckteller für Alu-Räder · Nut with thrust plate for aluminium wheels	48 - 52	febi Nr. > Ref.-Nr. · febi number > ref. number	107 - 116
Flachbundmuttern · Flat collar nuts	53 - 58		
Flachbundmutter mit Zentrieransatz · Flat collar nuts with center point	59		



**ALLEINE
STARK,
IM TEAM
UNSCHLAGBAR**

Die bilstein group ist eine familiengeführte, konzernunabhängige Unternehmensgruppe, unter deren starkem Dach die renommierten Produktmarken febi, SWAG und Blue Print vereint werden.

Als ein führender Spezialist im weltweiten Automotive Aftermarket bietet die bilstein group Verschleißteile und Reparaturlösungen für alle gängigen Fahrzeugtypen der Bereiche PKW und NKW.

Das in Breite und Tiefe außergewöhnliche Sortiment umfasst rund 47.000 verschiedene Produkte und wird durch praxisorientierte Serviceleistungen ergänzt. Damit wird die bilstein group selbst höchsten Ansprüchen gerecht.

Weitere Informationen erhalten Sie unter:
www.bilsteingroup.com

**INDIVIDUALLY
STRONG,
UNBEATABLE
AS A TEAM**

The bilstein group is a family-run, independent group of companies providing a single strong umbrella under which the prestigious product brands febi, SWAG and Blue Print are united.

As a leading specialist in the global automotive aftermarket, the bilstein group offers spare parts and repair solutions to fit all popular makes of cars and commercial vehicles.

The range, which is exceptional in its breadth and depth, comprises approximately 47,000 different products and is supplemented by practice-oriented services. The bilstein group can therefore meet even the highest requirements.

Get more information at: www.bilsteingroup.com

Lösungen „Made in Germany“ – Weltweit zu Hause

Mit mehr als 30.000 verschiedenen Ersatzteilen für PKW und NKW bietet febi bilstein ein stetig wachsendes Kompletprogramm für die professionelle Fahrzeugreparatur aller gängigen Marken und Modelle.

Kundeninteressen im Fokus

Als starker Partner von Handel und Werkstatt legen wir größten Wert auf Qualitätssicherung und Service-Orientierung. Daher finden Sie bei febi bilstein nur Produkte in geprüfter Erstausrüstungsqualität.

Zukunft im Blick

Als Lieferant und Hersteller nutzen wir unser langjähriges Know-how und modernste Fertigungstechnologien, um den steigenden Erwartungen des Marktes jederzeit zu entsprechen. Kontinuierlich investieren wir daher in den Ausbau

unserer Eigenfertigung, in Prüfeinrichtungen und die Erweiterung des Maschinenparks. Denn nur so können wir unserem Anspruch und den Erwartungen unserer Partner an eine überzeugende Qualitätssicherung gerecht werden.

febi bilstein Mehrwerte

- Erstausrüstungsqualität
- Lösungen „Made in Germany“
- Herstellerkompetenz
- Lieferung „Just in time“ in über 140 Länder



Solutions „Made in Germany“ – At home all over the world

With a product line of over 30,000 different parts for cars and commercial vehicles, febi bilstein offers a complete and constantly growing range of professional vehicle repair products for all current vehicle makes and models.

Focusing on our customers' interests

As a strong partner to the vehicle trade and workshops, our top priorities are quality assurance and service. This is why you will only find products of tested original equipment quality at febi bilstein.

Looking to the future

As a supplier and manufacturer, we use the know-how we have acquired over many years and state-of-the-art manufacturing technologies in order to meet the growing expectations of the market at all times. For this reason we are continually investing in the expansion of our in-house production, testing equipment and machinery at febi bilstein. Only this way are we able to fulfil both our own requirements and our partners' expectations in terms of credible quality assurance.

febi bilstein added value

- Original equipment quality
- Solutions “Made in Germany“
- Manufacturing expertise
- Just in time delivery in more than 140 countries



Eigenfertigung – Die Lizenz für Spitzenprodukte

„Made in Germany“ ist für uns Anspruch und Qualitätsversprechen zugleich. Daher investieren wir kontinuierlich in die Modernisierung unseres Maschinenparks.

Bereits seit 1844 ist febi bilstein in der Metallverarbeitung aktiv und verfügt damit über ein hohes Maß an Erfahrung. Diese Kombination aus Know-how und Präzisionstechnik fließt in die Entwicklung jedes Serienteils und ermöglicht die Herstellung selbst anspruchsvollster Produkte.

Wertschöpfung produzieren

febi bilstein bietet Ihnen ein komplettes Bearbeitungsspektrum mit hoher Präzision als Dienstleistung „aus einer Hand“ an. Die Fertigungsbereiche umfassen nahezu die vollständige Produktionskette: Von Materialbeschaffung und -analyse über Werkzeugbau, Zerspanung und Härterei bis hin zur computergestützten Qualitätsdokumentation. Die Einhaltung höchster Qualitätsstandards ist für uns bei jedem Schritt selbstverständlich.

Herstellerekompetenz auf allen Ebenen

Vertrauen Sie auf die Fertigungskompetenz aus dem Hause febi bilstein: Durch einen gezielten Wissens-Transfer vom Herstellungs- auf den Beschaffungsprozess legen wir auch bei der Auswahl von Partnerproduzenten die gleichen hohen Qualitätskriterien an, wie bei der Eigenfertigung.

Geprüfte febi Qualität:

- Made in Germany
- Modernster Maschinenpark
- Breites Bearbeitungsspektrum
- Facharbeiterquote > 90%



Committed to providing first class products

„Made in Germany“ for us means both high quality standards and commitment. As we have continuously developed our range, we have also considerably increased the proportion of in-house production parts and constantly invested in high-tech production technologies.

febi bilstein has been machining metal parts since 1844 and is therefore highly experienced in this area. This combination of know-how and precision technology lends itself to the development of every massproduced product and enables the production of even the most demanding parts.

Value Creation

febi bilstein is a „one-stop-shop“ for a complete range of high-precision production services. Our production processes cover nearly the whole production spectrum: From tool-making and machining, to hardening and in-house quality assurance and testing. As a manufacturer we recognise the need to maintain the highest quality standards at every step of the production process.

Manufacturer competence at all levels

You can put your trust in febi bilstein's manufacturing competence: By transferring know-how from the manufacturing process to the purchasing process, we apply the same high quality criteria to both partner production and in-house production.

Certified febi quality:

- Made in Germany
- Cutting-edge machinery
- Wide production range
- > 90% skilled worker quota



Ein vielseitiger, moderner Maschinenpark ermöglicht febi bilstein die Herstellung anspruchsvoller Teile.





Flexible, modern manufacturing equipment allows febi bilstein to produce demanding parts.

D

Benutzerhinweise: übersichtlich und einfach

Im febi Katalog befinden sich folgende Angaben die Ihnen dabei helfen, das richtige Radbefestigungszubehör zu finden:

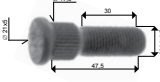
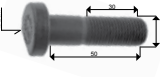
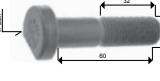
- 1 Art der Radbefestigung
- 2 Foto mit Abmessungen
- 3 Grundsätzlich sind die Teile nach Gewindedurchmesser und Länge aufsteigend sortiert
- 4 Informationen
- 5 In dieser Spalte erhalten Sie zusätzliche Informationen über weitere Eigenschaften des Ersatzteiles
- 6 febi Nummer
- 7 Fahrzeugdaten, passend für Hersteller

 		Radbolzen · Wheel stud · Goujon de roue · Gorrón de rueda · Colonnina ruota · Śruba koła · шпилька колесная	
		febi No.	passend für: to fit: adapté à: apropiado para: adatable per: passeje dia: подходящий для:
	Güte/Quality/qualité/calidad/qualita/ Jakob/Kачество 8.8 Oberfläche/Surface/surface/superficie/ superfici/Powierzchnia/поверхность phosphatiert/phosphated/ phosphate/fosfatat/fosfatzato/ fosforanowany/фосфатирование	04781	Bergische Achsen
	Güte/Quality/qualité/calidad/qualita/ Jakob/Kачество 10.9 Oberfläche/Surface/surface/superficie/ superfici/Powierzchnia/поверхность schwarz vergütet/black quenched and tempered/traité par trempé et revenu en noir/bonificado negro/ bonificata nera/czarna, utrzasyany ciepnie/ с термическим воронением	03176	EvoBus Mercedes-Benz
	Güte/Quality/qualité/calidad/qualita/ Jakob/Kачество 10.9 Oberfläche/Surface/surface/superficie/ superfici/Powierzchnia/поверхность phosphatiert/phosphated/ phosphate/fosfatat/fosfatzato/ fosforanowany/фосфатирование	01471	EvoBus Mercedes-Benz
	Güte/Quality/qualité/calidad/qualita/ Jakob/Kачество 10.9 Oberfläche/Surface/surface/superficie/ superfici/Powierzchnia/поверхность dacromet 500	32043	Mercedes-Benz
	Güte/Quality/qualité/calidad/qualita/ Jakob/Kачество 10.9 Oberfläche/Surface/surface/superficie/ superfici/Powierzchnia/поверхность phosphatiert/phosphated/ phosphate/fosfatat/fosfatzato/ fosforanowany/фосфатирование	43572	DAF

The part numbers of the Automobol plants must not be used for the calibration that is presented to the vehicle owners.
 The products delivered by us are to be put exclusively to the intended use.
 The installation may exclusively be performed by trained specialist staff.

13

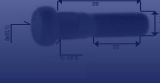
	Güte/Quality/qualité/calidad/qualita/ Jakob/Kачество 10.9 Oberfläche/Surface/surface/superficie/ superfici/Powierzchnia/поверхность phosphatiert/phosphated/ phosphate/fosfatat/fosfatzato/ fosforanowany/фосфатирование	43213	DAF
--	--	--------------	-----

GB

User notes: clear and simple

The febi catalogue has the following information which will help you to find the correct wheel fastening accessories.:

- 1 The type of wheel fastening
- 2 Photograph with dimensions
In principal the parts are sorted in ascending according to thread diameter and length
- 3 Information
This column gives you additional information about characteristics of the part
- 4 febi number
- 5 Vehicle data, to fit manufacturers

F

Information utilisateur: claire et simple

Vous trouverez dans le catalogue febi les indications suivantes pour vous aider à identifier les pièces

- 1 Type de fixation de roue
- 2 Photo avec dimensions
Les pièces sont triées selon le diamètre du filet et par longueur
- 3 Informations
Vous trouverez dans la colonne «Informations» des données supplémentaires sur les caractéristiques des pièces
- 4 N° febi
- 5 Données des véhicules, adapté à Constructeur

E

Para el usuario: claro y simple

El catálogo de febi proporciona los siguientes datos que le servirán de ayuda para encontrar los accesorios de fijación correctos para las ruedas:

- 1 Tipo de fijación
- 2 Foto con dimensiones
Por lo general, las piezas están clasificadas por diámetro de rosca y longitud
- 3 Información adicional
En esta columna encontrará información sobre otras características de la pieza de repuesto
- 4 Número de febi
- 5 Características técnicas del vehículo, apropiado para fabricante

I

Indicazioni per l'utente: chiare e semplici

Nel catalogo febi si trovano i seguenti dati che Vi possono aiutare a rintracciare il ricambio di fissaggio ruota adatto:

- 1 Tipo del fissaggio ruota
- 2 Illustrazione con dimensioni
In generale gli articoli sono ordinati in senso crescente in base al diametro del filetto e alla lunghezza
- 3 Informazioni
In questa sezione si possono ricavare informazioni aggiuntive relative a ulteriori caratteristiche del ricambio
- 4 N. febi
- 5 Dati relativi ai veicoli, adattabile per produttore

D

Ersatzteile finden: komfortabel und schnell

- Sie kennen den Fahrzeugtyp und haben eine Referenznummer des Fahrzeugherstellers:

Referenz-Nr. → febi-Nr. → Seitenzahl

- Die Anordnung der Referenznummern entspricht der Sortierreihenfolge der Fahrzeughersteller:

febi-Nr. → Referenz-Nr. → Seitenzahl

- Diese Liste ist nach febi-Nr. aufsteigend sortiert.

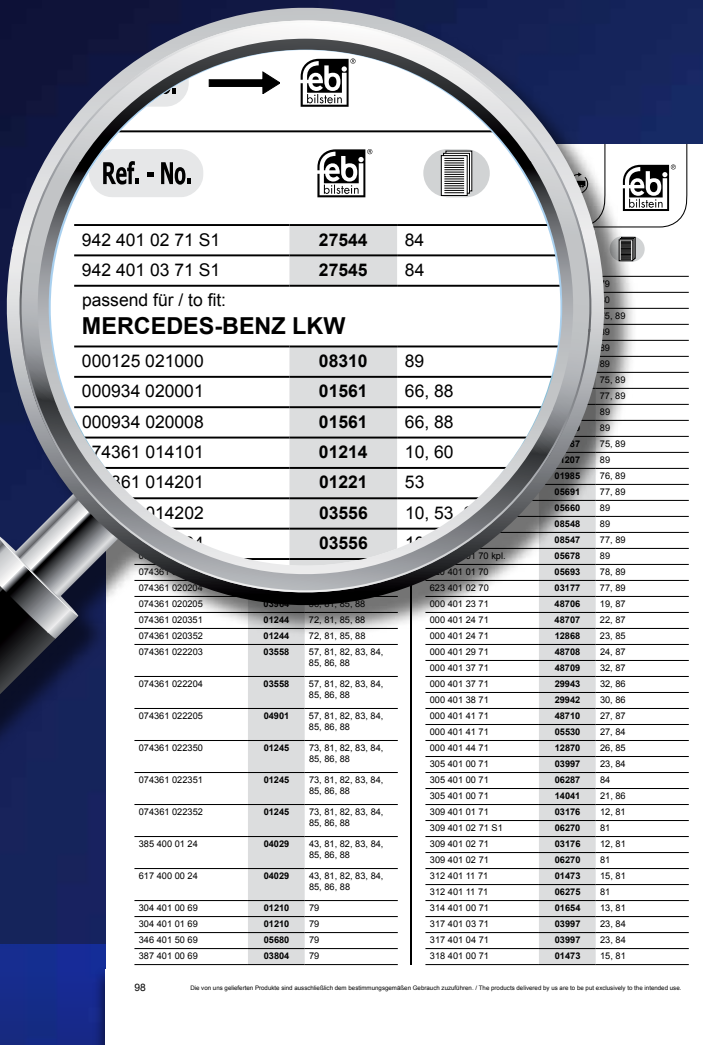

GB

Find every part: quick and convenient

- You know the vehicle type and the vehicle manufacturer's reference number:

Reference number → febi number → Page number

- The positioning of the reference numbers corresponds to the vehicle manufacturers' sorting sequence:

febi number → Reference number → Page number

- This list is sorted by febi number in ascending order.

F

Trouvez vos pièces: facilement et rapidement

- Vous connaissez le type du véhicule et avez la référence de son constructeur:

Référence → N° febi → Numéro de page

- Le classement des références correspond à l'ordre de classement du constructeur de véhicules:

N° febi → Référence → Numéro de page

- Cette liste est triée par référence febi, en ordre croissant.

E

Búsqueda de cualquier recambio: rápida y cómoda

- Sabe usted cuál es el tipo de vehículo y tiene un número de referencia del fabricante del vehículo:

N° de referencia → N° de febi → N° de página

- La clasificación de los números de referencia corresponden al orden de clasificación de los fabricantes de vehículos:

N° de febi → N° de referencia → N° de página

- En esta lista se indican las referencias de febi en orden ascendente.

I

Trovate comodamente e velocemente i pezzi di ricambio

- Se si è a conoscenza del tipo di veicolo e inoltre in possesso di un numero di riferimento del costruttore del veicolo:

Rif. comparativo → Rif. febi → Page N°

La classificazione dei numeri di riferimento corrisponde alla sequenza utilizzata dai costruttori:

Rif. febi → Rif. comparativo → Page N°

- Questa lista è per riferimento febi in ordine crescente.

NKW-Radbefestigung von febi bilstein - mit Sicherheit ankommen

febi bilstein liefert Radbolzen und Radmutter für LKW, Anhänger, Auflieger und Busse. Das Sortiment umfasst mehr als 170 Artikel, passend für alle namhaften europäischen NKW-Hersteller.

Bei der Wahl von Radbefestigungen steht die Sicherheit immer im Vordergrund. Radbolzen und Radmutter von febi bilstein bieten hervorragende Montageeigenschaften und hochwertige Qualität.

Sämtliche Radbefestigungsteile sind ebenso widerstandsfähig wie sicher und werden entsprechend der OE-Ausführung hergestellt.

Das umfangreiche Produktprogramm an Radbolzen und Radmutter umfasst Ausführungen für alle gängigen Fahrzeughersteller und Bauarten unter den höchsten Güteansprüchen an das Material und die Verarbeitung. So bietet febi bilstein auch bei sicherheitsrelevanten Bauteilen wie diesen ein Maximum an Zuverlässigkeit und Langlebigkeit.

Zur Radbefestigung dienen je nach Typ Flachbundradmutter, Radmutter mit Drucktellern oder Kegel- bzw. Kegelbundmutter. Außerdem bietet febi bilstein für die Umrüstung auf Leichtmetallräder auch Radmutter mit Druckteller und Zentrierhülse an.



Bei Verwendung hochwertiger Radbolzen und -mutter sparen Sie unter Beachtung der Herstellervorgaben den Einsatz von Radmutterindikatoren.

If you use high-quality wheel bolts and nuts and follow the manufacturer's instructions there will be no need for wheel nut indicators.

Warum diese hohen Qualitätsansprüche?

Radmutter sind sicherheitsrelevante Verschleißteile. Im Laufe ihres Einsatzes am Fahrzeug überdauern sie viele Radwechsel, Instandhaltungs- und Instandsetzungsarbeiten.

Unzählige Male werden diese gelöst und wieder montiert. Reib-, Zug- und Druckkräfte fordern das Material stark und lassen in Sachen Qualität keinen Platz für Kompromisse.

Daher setzt febi bilstein auf allerhöchste Materialgüte und Passform und nimmt sich das Erstausrüstungsteil als Maßstab für diese Werte.

Durch den exakt gearbeiteten und angepassten Druckteller wird ein Mitdrehen während des Anzugvorganges verhindert. Durch die sogenannte Vorspannung des Drucktellers bekommt die Radmutter erst beim vorschriftsmäßigen Anzugsdrehmoment ihren finalen Sitz am Rad.

Das richtige Material, die breite Auflage des Drucktellers und das vom Fahrzeughersteller vorgeschriebene Drehmoment sorgen für einen festen und sicheren Sitz, was eine zusätzliche Verdrehsicherung überflüssig macht.

Wheel fastening for commercial vehicles from febi bilstein - Arrive safely

febi bilstein supplies wheel bolts and wheel nuts for trucks, trailers, semitrailers and buses. The range includes more than 170 items suitable for all wellknown European manufacturers of commercial vehicles.

Safety is always the top priority when choosing wheel fastenings. Wheel bolts and wheel nuts from febi bilstein have excellent fitting properties and first-class quality, to ensure they are both safe and robust. All parts of the wheel fastening are manufactured in line with the OE version.

The extensive range of wheel bolts and wheel nuts includes versions for all popular vehicle manufacturers and models, applying the highest quality requirements to material and workmanship. As a result, febi bilstein offers maximum reliability and durability also for safety critical components such as wheel fastenings.

Depending on the type of wheel fastening, flat collar wheel nuts, wheel nuts with pressure plates, domed wheel nuts and conical collar nuts are used. febi bilstein also supplies wheel nuts with pressure plates and centring sleeve for the conversion to aluminium rims.

Why are these quality requirements so high?

Wheel nuts are safety-critical spare parts. During the time they are fitted to the vehicle they outlast many wheel changes, maintenance and repair jobs.

These parts are unscrewed countless times before being refitted. Friction, tension and compression forces place high demands on the material and leave no room for compromise when it comes to quality.

This is the reason why febi bilstein relies on optimum material quality and perfect fit and uses the OEM part as a standard for these values.

There is no rotation of the pressure plate during the tightening process thanks to precision machining and perfect fit. Due to what is referred to as pre-tensioning of the pressure plate, the wheel nut only takes up its final position on the wheel when the tightening torque specified is reached.

The correct material, the wide seating surface of the pressure plate and the correct torque ensure a firm, secure seat which makes any additional anti-rotation device superfluous.



febi Radmutter für
Leichtmetallfelgen

febi wheel nut for
light metal rims

Sparen Sie Zeit und Geld - mit Werkstattlösungen von febi bilstein

Save time and money - with workshop solutions from febi bilstein

Erst die gewölbte (konkave) Form der Unterseite des Federtellers gibt der febi Radmutter ihren sicheren Sitz und macht zusätzliche Verdrehsicherungen überflüssig.

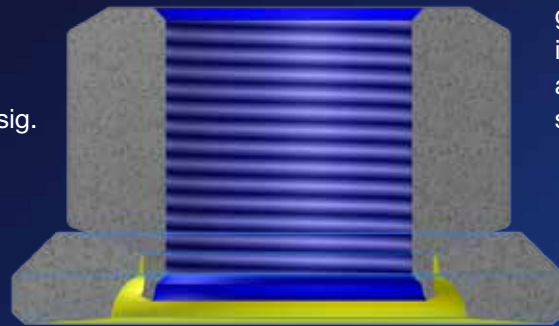

febi Radmuttern - mehrfach verwendbar und mit konstanter Klemmwirkung

The dome-shaped (concave) underside of the spring plate gives the febi wheel nut its secure seat and makes additional anti-rotation devices superfluous.

febi wheel nuts – suitable for multiple use with a constant clamping effect

Der optimierte Sitz des febi Bolzens verhindert eine Beschädigung der Nabe bei der Montage. Dies ermöglicht eine Wiederverwendung im Reparaturfall.



The optimised seat of the febi bolt prevents damage to the hub during fitting. This allows re-use in the event of repair.

febi Wendelradbolzen – die ideale Reparaturlösung

febi helical shank wheel bolts – the ideal repair solution

Darauf sollten Sie beim Radwechsel achten!

Oberflächen:

Die Oberflächen der Felgeninnenseite und der Radnabe sollten sauber und rostfrei sein. Bei unsauberen Auflageflächen besteht die Gefahr, dass Rost oder Schmutz sich mit der Zeit lösen und das Anzugsmoment der Radmutter sich negativ verändert.

Zustand:

Der Zustand des Radbolzens und der Radmutter sollte einwandfrei sein. Mängel wie loser Sitz des Bolzens in der Nabe, ein überstreckter Bolzen, defektes Gewinde oder ein Druckteller, der nicht frei dreht, können zu verfälschten Anzugsmomenten führen. Dies führt im schlimmsten Fall zur Beschädigung der Radnabe und Felge und erhöht die Gefahr eines Unfalls.

Reihenfolge:

Beim Anziehen der Radmutter ist auf die richtige Reihenfolge zu achten. Diese sollte stets nach Angaben des Herstellers gewählt werden. Grund dafür sind eventuelle Materialverspannungen durch ungleichmäßige Kraftverteilung. Dies hätte zur Folge, dass die Radmutter sich auch hier lösen könnten und kostspielige Reparaturen notwendig wären.

Drehmoment:

Bei der Wahl des Drehmoments ist ausschließlich auf die Angaben des Herstellers zu achten. Ein abweichendes Drehmoment hätte in jedem Fall eine kosten- und zeitaufwändige Reparatur zur Folge. Bei der Wahl des richtigen Drehmoments und der Verwendung von febi Radbefestigungsteilen ist ein zusätzliches Sichern nicht mehr notwendig.

A few things to bear in mind when changing a wheel

Surfaces:

The surfaces on the inside of the rim and the wheel hub should be clean and free of rust. Rust and dirt can loosen from dirty seating surfaces over time and have an adverse effect on the tightening torque of the wheel nuts.

Condition:

The wheel bolt and wheel nut should both be in perfect condition. Defects such as the bolt being loosely seated in the hub, an overextended bolt, a faulty thread or pressure plate that does not rotate freely can lead to distorted tightening torques. In the worst case, this leads to damage to the wheel hub and rim and increases the risk of an accident.

Sequence:

It is imperative to follow the correct sequence when tightening the wheel nuts. This should always be in accordance with the manufacturer's instructions. The reason for this is potential material stresses due to the uneven distribution of forces. As a consequence, wheel nuts could loosen and cause expensive repairs.

Torque:

It is imperative to pay attention to the manufacturer's instructions when selecting the torque. A non-compliant torque would in any case lead to a costly and time-consuming repair. No further securing is necessary if the correct torque is selected and febi wheel fastening parts are used.

Alle NKW-Kataloge

Auch diese Kataloge könnten Sie interessieren.
Bitte notieren Sie sich die Katalognummer und
bestellen Sie direkt unter: www.febi.com

All Commercial Vehicle Catalogues

You might find these catalogues of interest as well.
Please note the catalogue number and order
directly from: www.febi.com

Linienkataloge NKW passend für ·

Line Catalogues for Commercial Vehicles to fit

90361	Bremsklotz / Bremsscheibe Brake Pad / Brake Disc	90158	Lenkung und Aufhängung Steering and Suspension
90203	Elektrik Electrics	90125	Radbefestigung Wheel Fastening
90223	Fahrerhauskomponenten Cabin components	90345	Riementriebkomponenten Belt Drive Components
90210	febiplus · D	90207	Stabilisatorlager Stabilizer Mountings
90211	febiplus · GB	90220	Wasserpumpen Water Pumps
90204	Gasdruckfedern Gas Pressure Springs		

Online Kataloge passend für · Online Catalogues to fit

90206	MAN TGA · D, GB	90221	Scania P/G/R/T D, GB, F, ES, I, PL, RUS
90218	MAN TGS / TGX D, GB	90360	DAF XF D, GB
90157	MB Special Edition GB	90219	Iveco Stralis D, GB, F, ES, I, PL, RUS

Typenkataloge NKW passend für·

Type Catalogues for Commercial Vehicles to fit

90026	DAF · D, GB, F, ES, I, PL, RUS	90000	Mercedes-Benz · D, GB, F, ES, I, PL, RUS
90052	EvoBus · D, GB, F, ES, I, PL, RUS	90335	MB Actros, Axor · D, GB
90037	Iveco · D, GB, F, ES, I, PL, RUS	90205	MB LK-Atego · D, GB
90219	Iveco Stralis · D, GB, F, ES, I, PL, RUS	90042	Renault · D, GB, F, ES, I, PL, RUS
90001	Kleintransporter / Vans · GB	90045	Scania · D, GB, F, ES, I, PL, RUS
90002	Kleintransporter / Vans · ES	90050	Volvo · D, GB, F, ES, I, PL, RUS
90039	MAN · D, GB, F, ES, I, PL, RUS	90222	Volvo FH · D, GB
90206	MAN TGA · D, GB		



Unser spezieller Katalogservice für Sie:

- Mehr als 340 Teile.
- Schnelle Teilefindung durch klare und übersichtliche Darstellungen.
- Einfache Teilefindung durch Kapitelgliederung.

Our special catalogue service for you:

- More than 340 parts.
- Clear layout allows quick parts identification.
- Simple to find parts thanks to grouping of sections.

Spécialement pour vousm notre service catalogue:

- Plus que 340 pièces.
- À travers une conception claire, trouver rapidement et simplement les pièces.
- Découverte simple des diverses parties par chapitres.

¡Nuestro servicio especial de catálogos para usted!:



- Más que 340 piezas.
- Con esquema detallado para su búsqueda rápida y segura.
- Encontrar piezas de modo sencillo por división en capítulos.



Il nostro speciale catalogo di servizi per voi:

- Pio che 340 pordotti.
- Ricerca dell'articolo facile e veloce tramite la chiara rappresentazione della grafica.
- Semplice individuazione pezzi attraverso la strutturazione in capitoli.



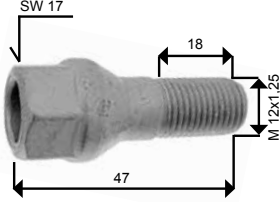
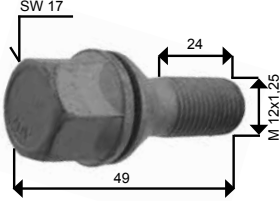
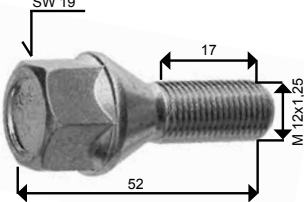
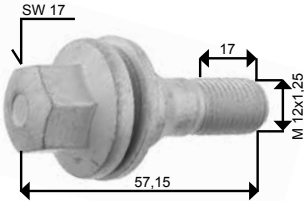



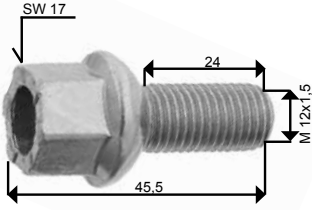
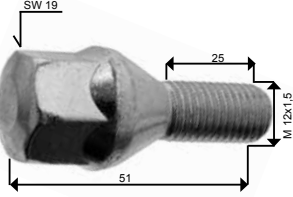
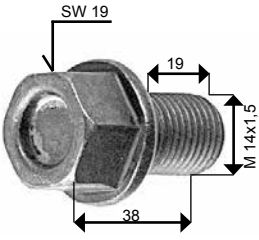
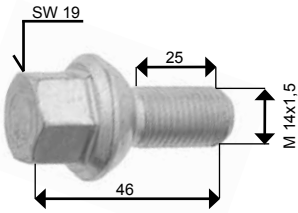



 		<p>passend für: to fit: adapté à: apropiado para: adattabile per: pasuje dla: подходящий для:</p>
 <p>Güte/Quality/qualité/calidad/qualità/ Jakość/Качество 10,9</p> <p>Oberfläche/Surface/surface/superficie/ superfici/Powierzchnia/поверхность dacromet</p>	<p>21175</p>	<p>Citroën Fiat Peugeot</p> <p>Stahl-Räder Steel-Rims Jantes en acier Llantas de acero Cerchi in acciaio Stalowe Koła Стальные диски</p>
 <p>Güte/Quality/qualité/calidad/qualità/ Jakość/Качество 10,9</p> <p>Oberfläche/Surface/surface/superficie/ superfici/Powierzchnia/поверхность geomet защитное покрытие около винтов</p>	<p>30400</p>	<p>Citroën Fiat Peugeot</p> <p>Stahl-Räder Steel-Rims Jantes en acier Llantas de acero Cerchi in acciaio Stalowe Koła Стальные диски</p>
 <p>Güte/Quality/qualité/calidad/qualità/ Jakość/Качество 10,9</p> <p>Oberfläche/Surface/surface/superficie/ superfici/Powierzchnia/поверхность verzinkt galvanized galvanisé galvanizado zincato осцинкованы оцинкованный</p>	<p>11616</p>	<p>Citroën Peugeot</p> <p>Stahl-Räder Steel-Rims Jantes en acier Llantas de acero Cerchi in acciaio Stalowe Koła Стальные диски</p>
 <p>Güte/Quality/qualité/calidad/qualità/ Jakość/Качество 10,9</p> <p>Oberfläche/Surface/surface/superficie/ superfici/Powierzchnia/поверхность geomet защитное покрытие около винтов</p>	<p>29208</p>	<p>Citroën Fiat Peugeot</p> <p>Alu-Räder Alu-Rims Alu-Jantes Alu-Llantas Alu-cerchioni Aluminiowe Koła Легкосплавные диски</p>

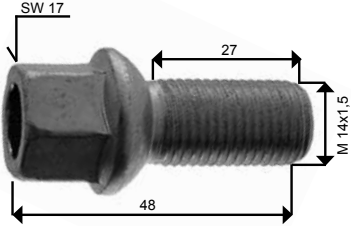
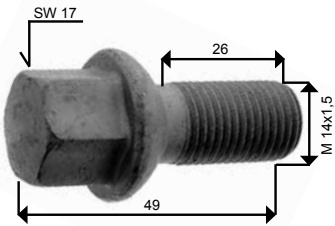
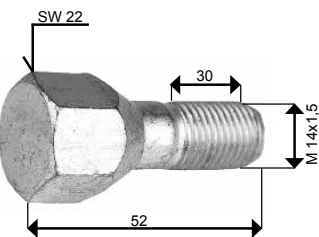
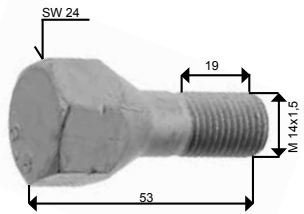

 		passend für: to fit: adapté à: apropiado para: adattabile per: pasuje dla: подходящий для:
 <p>Güte/Quality/qualité/calidad/qualità/ Jakość/Качество 10.9</p> <p>Oberfläche/Surface/surface/siperficie/ superfici/Powierzchnia/поверхность gelb verzinkt yellow galvanized galvanisé jaune amarillo galvanizado zincato giallo осынокваны на зóлто желтая оцинковка</p>	06963	Volkswagen Stahl u. Alu-Räder Steel a. Alu-Rims Acier et Alu-Jantes Acero y Alu-Llantas Acciaio i Alu-Cerchioni Stalowe i Aluminiowe Koła Стальные и Легкосплавные диски
 <p>Güte/Quality/qualité/calidad/qualità/ Jakość/Качество 10.9</p> <p>Oberfläche/Surface/surface/siperficie/ superfici/Powierzchnia/поверхность verzinkt galvanized galvanisé galvanizado zincato осынокваны оцинкованный</p>	02062	Renault Stahl u. Alu-Räder Steel a. Alu-Rims Acier et Alu-Jantes Acero y Alu-Llantas Acciaio i Alu-Cerchioni Stalowe i Aluminiowe Koła Стальные и Легкосплавные диски
 <p>Güte/Quality/qualité/calidad/qualità/ Jakość/Качество 10.9</p> <p>Oberfläche/Surface/surface/siperficie/ superfici/Powierzchnia/поверхность phosphatiert phosphated phosphaté fosfatar fosfatizzato fosforanowany фосфатирование</p>	01664	Volkswagen Stahl-Räder Steel-Rims Jantes en acier Llantas de acero Cerchi in acciaio Stalowe Koła Стальные диски
 <p>Güte/Quality/qualité/calidad/qualità/ Jakość/Качество 10.9</p> <p>Oberfläche/Surface/surface/siperficie/ superfici/Powierzchnia/поверхность weiß verzinkt white galvanized blanc galvanisé blanco galvanizado col. bianco zincato biały осынокваны белый оцинкованный</p>	09805	Mercedes-Benz Stahl-Räder Steel-Rims Jantes en acier Llantas de acero Cerchi in acciaio Stalowe Koła Стальные диски



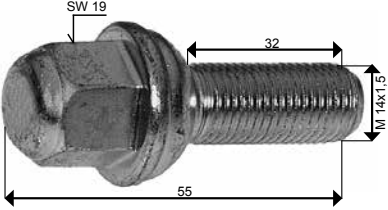
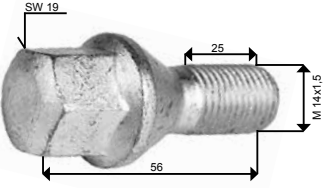
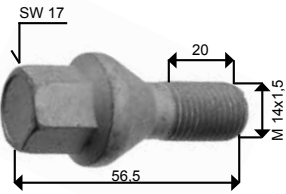
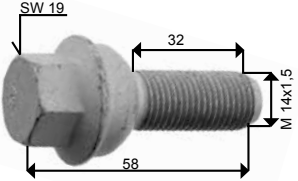

 		passend für: to fit: adapté à: apropiado para: adattabile per: pasuje dla: подходящий для:
 <p>Güte/Quality/qualité/calidad/qualità/ Jakość/Качество 8.8</p> <p>Oberfläche/Surface/surface/siperficie/ superfici/Powierzchnia/поверхность verzinkt galvanized galvanisé galvanizado zincato осынокваны оцинкованный</p>	09801	Skoda Volkswagen Stahl u. Alu-Räder Steel a. Alu-Rims Acier et Alu-Jantes Acero y Alu-Llantas Acciaio i Alu-Cerchioni Stalowe i Aluminiowe Koła Стальные и Легкосплавные диски
 <p>Güte/Quality/qualité/calidad/qualità/ Jakość/Качество 10.9</p> <p>Oberfläche/Surface/surface/siperficie/ superfici/Powierzchnia/поверхность dacromet</p>	18913	Mercedes-Benz Stahl u. Alu-Räder Steel a. Alu-Rims Acier et Alu-Jantes Acero y Alu-Llantas Acciaio i Alu-Cerchioni Stalowe i Aluminiowe Koła Стальные и Легкосплавные диски
 <p>Güte/Quality/qualité/calidad/qualità/ Jakość/Качество 8.8</p> <p>Oberfläche/Surface/surface/siperficie/ superfici/Powierzchnia/поверхность dacromet</p>	12706	Citroën FIAT Peugeot Stahl-Räder Steel-Rims Jantes en acier Llantas de acero Cerchi in acciaio Stalowe Koła Стальные диски
 <p>Güte/Quality/qualité/calidad/qualità/ Jakość/Качество 10.9</p> <p>Oberfläche/Surface/surface/siperficie/ superfici/Powierzchnia/поверхность geomet защитное покрытие около винтов</p>	32440	Citroën FIAT Peugeot Stahl-Räder Steel-Rims Jantes en acier Llantas de acero Cerchi in acciaio Stalowe Koła Стальные диски

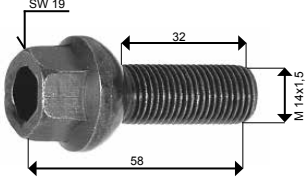
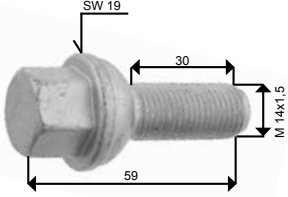
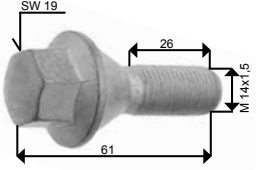
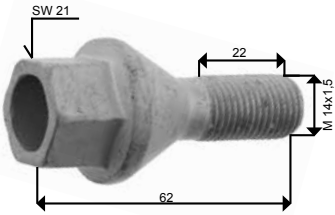

 		passend für: to fit: adapté à: apropiado para: adattabile per: pasuje dla: подходящий для:
 <p>Güte/Quality/qualité/calidad/qualità/ Jakość/Kачество 10.9</p> <p>Oberfläche/Surface/surface/siperficie/ superfici/Powierzchnia/поверхность verzinkt galvanized galvanisé galvanizado zincato осункованы оцинкованный</p>	08237	Mercedes-Benz Volkswagen Stahl-Räder Steel-Rims Jantes en acier Llantas de acero Cerchi in acciaio Stalowe Koła Стальные диски
 <p>Güte/Quality/qualité/calidad/qualità/ Jakość/Kачество 10,9</p> <p>Oberfläche/Surface/surface/siperficie/ superfici/Powierzchnia/поверхность dacromet</p>	12707	Citroën FIAT Lancia Peugeot Stahl-Räder Steel-Rims Jantes en acier Llantas de acero Cerchi in acciai Stalowe Koła Стальные диски
 <p>Güte/Quality/qualité/calidad/qualità/ Jakość/Kачество 10,9</p> <p>Oberfläche/Surface/surface/siperficie/ superfici/Powierzchnia/поверхность geomet защитное покрытие около винтов</p>	32439	Citroën FIAT Peugeot Stahl-Räder Steel-Rims Jantes en acier Llantas de acero Cerchi in acciai Stalowe Koła Стальные диски
 <p>Güte/Quality/qualité/calidad/qualità/ Jakość/Kачество 10.9</p> <p>Oberfläche/Surface/surface/siperficie/ superfici/Powierzchnia/поверхность dacromet</p>	29466	Mercedes-Benz Volkswagen Stahl u. Alu-Räder Steel a. Alu-Rims Acier et Alu-Jantes Acero y Alu-Llantas Acciaio i Alu-Cerchioni Stalowe i Aluminiowe Koła Стальные и Легкосплавные диски

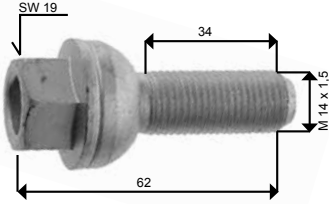
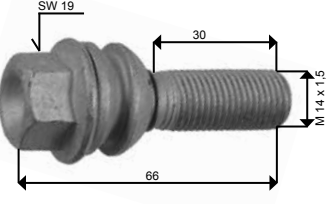
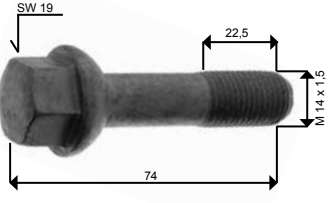
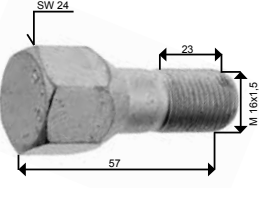

 		passend für: to fit: adapté à: apropiado para: adattabile per: pasuje dla: подходящий для:
 <p>Güte/Quality/qualité/calidad/qualità/ Jakość/Kачество 10.9</p> <p>Oberfläche/Surface/surface/siperficie/ superfici/Powierzchnia/поверхность phosphatiert phosphated phosphaté fosfatar fosfatizzato fosforowany фосфатирование</p>	04912	Ford Seat Volkswagen Stahl u. Alu-Räder Steel a. Alu-Rims Acier et Alu-Jantes Acero y Alu-Llantas Acciaio i Alu-Cerchioni Stalowe i Aluminiowe Koła Стальные и Легкосплавные диски
 <p>Güte/Quality/qualité/calidad/qualità/ Jakość/Kачество 10.9</p> <p>Oberfläche/Surface/surface/siperficie/ superfici/Powierzchnia/поверхность dacromet</p>	24645	Mercedes-Benz Stahl-Räder Steel-Rims Jantes en acier Llantas de acero Cerchi in acciaio Stalowe Koła Стальные диски
 <p>Güte/Quality/qualité/calidad/qualità/ Jakość/Kачество 8.8</p> <p>Oberfläche/Surface/surface/siperficie/ superfici/Powierzchnia/поверхность dacromet 500</p>	26747	Nissan Opel Renault Vauxhall Stahl u. Alu-Räder Steel a. Alu-Rims Acier et Alu-Jantes Acero y Alu-Llantas Acciaio i Alu-Cerchioni Stalowe i Aluminiowe Koła Стальные и Легкосплавные диски
 <p>Güte/Quality/qualité/calidad/qualità/ Jakość/Kачество 10.9</p> <p>Oberfläche/Surface/surface/siperficie/ superfici/Powierzchnia/поверхность geomet защитное покрытие около винтов</p>	32441	Citroën Fiat Peugeot Stahl u. Alu-Räder Steel a. Alu-Rims Acier et Alu-Jantes Acero y Alu-Llantas Acciaio i Alu-Cerchioni Stalowe i Aluminiowe Koła Стальные и Легкосплавные диски

 		passend für: to fit: adapté à: apropiado para: adattabile per: pasuje dla: подходящий для:
 <p>Güte/Quality/qualité/calidad/qualità/ Jakość/Качество 10.9</p> <p>Oberfläche/Surface/surface/siperficie/ superfici/Powierzchnia/поверхность geomet защитное покрытие около винтов</p>	17818	Ford Volkswagen Stahl u. Alu-Räder Steel a. Alu-Rims Acier et Alu-Jantes Acero y Alu-Llantas Acciaio i Alu-Cerchioni Stalowe i Aluminiowe Koła Стальные и Легкосплавные диски
 <p>Güte/Quality/qualité/calidad/qualità/ Jakość/Качество 10.9</p> <p>Oberfläche/Surface/surface/siperficie/ superfici/Powierzchnia/поверхность geomet защитное покрытие около винтов</p>	21588	Volkswagen Stahl u. Alu-Räder Steel a. Alu-Rims Acier et Alu-Jantes Acero y Alu-Llantas Acciaio i Alu-Cerchioni Stalowe i Aluminiowe Koła Стальные и Легкосплавные диски
 <p>Güte/Quality/qualité/calidad/qualità/ Jakość/Качество 10.9</p> <p>Oberfläche/Surface/surface/siperficie/ superfici/Powierzchnia/поверхность dacromet</p>	09806	Mercedes-Benz Alu-Räder Alu-Rims Alu-Jantes Alu-Llantas Alu-cerchioni Aluminiowe Koła Легкосплавные диски
 <p>Güte/Quality/qualité/calidad/qualità/ Jakość/Качество 10.9</p> <p>Oberfläche/Surface/surface/siperficie/ superfici/Powierzchnia/поверхность geomet защитное покрытие около винтов</p>	32450	Citroën FIAT Peugeot Stahl-Räder Steel-Rims Jantes en acier Llantas de acero Cerchi in acciaio Stalowe Koła Стальные диски

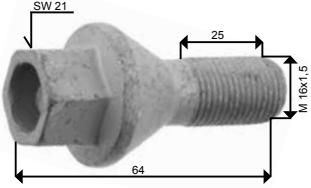
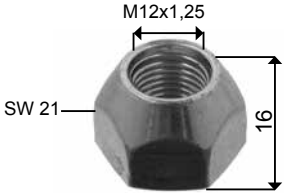
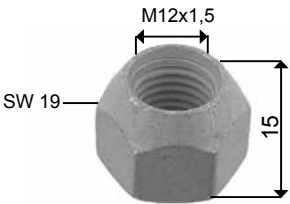
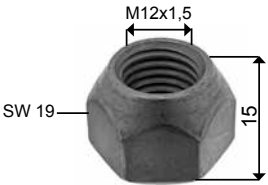

 		passend für: to fit: adapté à: apropiado para: adattabile per: pasuje dla: подходящий для:
 <p>Güte/Quality/qualité/calidad/qualità/ Jakość/Kачество 10.9</p> <p>Oberfläche/Surface/surface/siperficie/ superfici/Powierzchnia/поверхность geomet защитное покрытие около винтов</p>	32442	Citroën FIAT Peugeot Stahl u. Alu-Räder Steel a. Alu-Rims Acier et Alu-Jantes Acero y Alu-Llantas Acciaio i Alu-Cerchioni Stalowe i Aluminiowe Koła Стальные и Легкосплавные диски
 <p>Güte/Quality/qualité/calidad/qualità/ Jakość/Kачество 6</p> <p>Oberfläche/Surface/surface/siperficie/ superfici/Powierzchnia/поверхность gelb verzinkt yellow galvanized galvanisé jaune amarillo galvanizado zincato giallo осыпкованы на жёлто желтая оцинковка</p>	11938	Nissan Stahl-Räder Steel-Rims Jantes en acier Llantas de acero Cerchi in acciaio Stalowe Koła Стальные диски
 <p>Güte/Quality/qualité/calidad/qualità/ Jakość/Kачество 10</p> <p>Oberfläche/Surface/surface/siperficie/ superfici/Powierzchnia/поверхность magni</p>	27413	Ford Stahl-Räder Steel-Rims Jantes en acier Llantas de acero Cerchi in acciaio Stalowe Koła Стальные диски
 <p>Güte/Quality/qualité/calidad/qualità/ Jakość/Kачество 10</p> <p>Oberfläche/Surface/surface/siperficie/ superfici/Powierzchnia/поверхность Zink-Nickel-beschichtet zinc-nickel-coated avec enduction étain-nickel Recubierto de cinc-niquel rivestito di zinco-nichel powłoka cynkowo-niklowa с цинко-никелевым покрытием</p>	40247	Ford Stahl-Räder Steel-Rims Jantes en acier Llantas de acero Cerchi in acciaio Stalowe Koła Стальные диски



passend für:
 to fit:
 adapté à:
 apropiado para:
 adattabile per:
 pasuje dla:
 подходящий для:

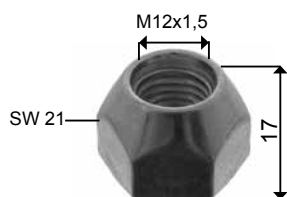

Güte/Quality/qualité/calidad/qualità/
 Jakość/Качество
8

Oberfläche/Surface/surface/siperficie/
 superfici/Powierzchnia/поверхность
gelb verzinkt
yellow galvanized
galvanisé jaune
amarillo galvanizado
zincato giallo
осынокваны на жолто
желтая оцинковка

11939

Citroen
 Daihatsu
 Hyundai
 Mitsubishi
 Peugeot
 Toyota

Stahl u. Alu-Räder
 Steel a. Alu-Rims
 Acier et Alu-Jantes
 Acero y Alu-Llantas
 Acciaio i Alu-Cerchioni
 Stalowe i Aluminiowe Koła
 Стальные и Легкосплавные
 диски

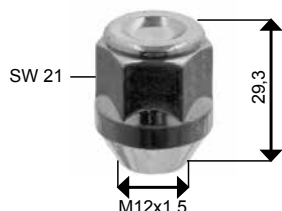

Güte/Quality/qualité/calidad/qualità/
 Jakość/Качество
8

Oberfläche/Surface/surface/siperficie/
 superfici/Powierzchnia/поверхность
verchromt
chromed
chromé
cromado
cromado
chromowany
хромированный

34754

Hyundai

Alu-Räder
 Alu-Rims
 Alu-Jantes
 Alu-Llantas
 Alu-cerchioni
 Aluminiowe Koła
 Легкосплавные диски

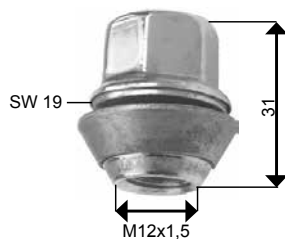

Güte/Quality/qualité/calidad/qualità/
 Jakość/Качество
8





Oberfläche/Surface/surface/siperficie/
 superfici/Powierzchnia/поверхность
verzinkt
galvanized
galvanisé
galvanizado
zincato
осынокваны
оцинкованный



03427

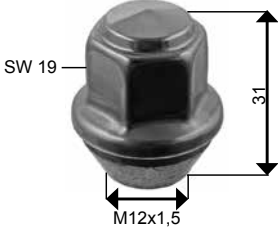

Ford
 Rover

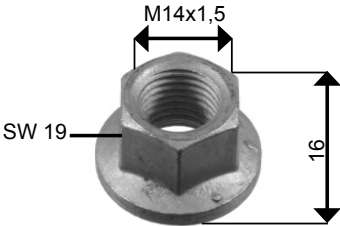

Alu-Räder
 Alu-Rims
 Alu-Jantes
 Alu-Llantas
 Alu-cerchioni
 Aluminiowe Koła
 Легкосплавные диски
 universell verwendbar
 universal application
 universellement utilisable
 universalmente aplicable
 applicazione universale
 stosowany uniwersalnie
 универсальное применение

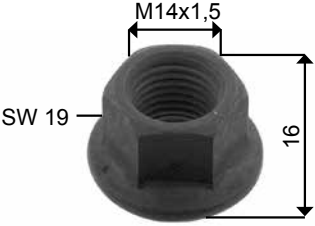
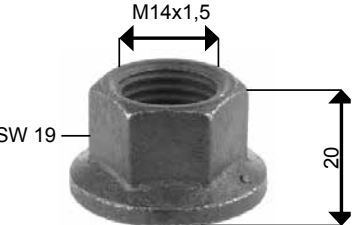
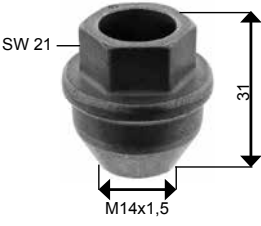



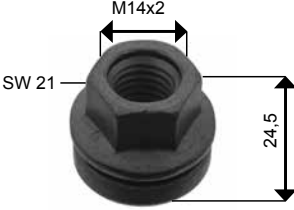
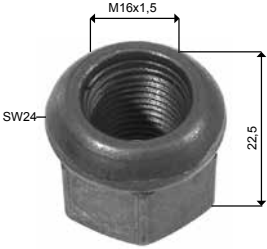
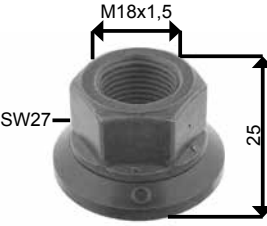

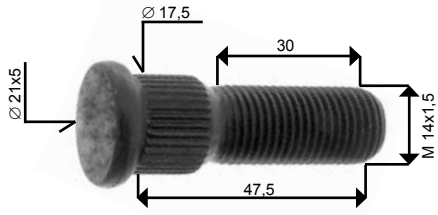
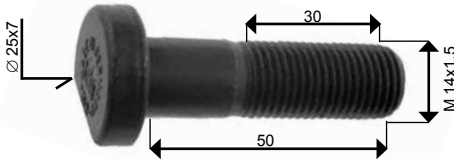
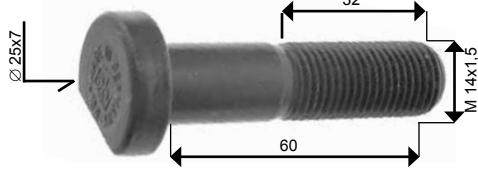
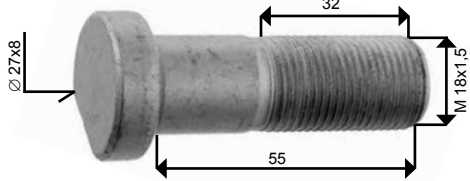

 		passend für: to fit: adapté à: apropiado para: adattabile per: pasuje dla: подходящий для:
 <p>Güte/Quality/qualité/calidad/qualità/ Jakość/Качество 10</p> <p>Oberfläche/Surface/surface/siperficie/ superfici/Powierzchnia/поверхность verchromt chromed chromé cromado cromado chromowany хромированный</p>	44949	Ford Stahl u. Alu-Räder Steel a. Alu-Rims Acier et Alu-Jantes Acero y Alu-Llantas Acciaio i Alu-Cerchioni Stalowe i Aluminiowe Koła Стальные и Легкосплавные диски
 <p>Güte/Quality/qualité/calidad/qualità/ Jakość/Качество 10</p> <p>Oberfläche/Surface/surface/siperficie/ superfici/Powierzchnia/поверхность verzinkt galvanized galvanisé galvanizado zincato осынокwany оцинкованный</p>	36655	Ford Stahl-Räder Steel-Rims Jantes en acier Llantas de acero Cerchi in acciaio Stalowe Koła Стальные диски
 <p>Güte/Quality/qualité/calidad/qualità/ Jakość/Качество 10</p> <p>Oberfläche/Surface/surface/siperficie/ superfici/Powierzchnia/поверхность geomet защитное покрытие около винтов</p>	22474	Mercedes-Benz Stahl-Räder Steel-Rims Jantes en acier Llantas de acero Cerchi in acciaio Stalowe Koła Стальные диски universell verwendbar universal application universellement utilisable universalmente aplicable applicazione universale stosowany uniwersalnie универсальное применение

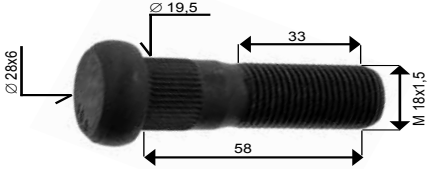
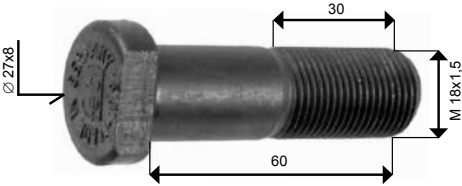
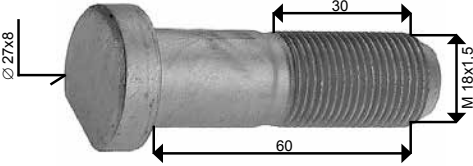
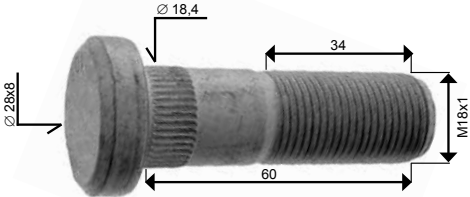

 		passend für: to fit: adapté à: apropiado para: adattabile per: pasuje dla: подходящий для:
 <p>Güte/Quality/qualité/calidad/qualità/ Jakość/Качество 10</p> <p>Oberfläche/Surface/surface/siperficie/ superfici/Powierzchnia/поверхность phosphatiert phosphated phosphaté fosfatar fosfatizzato fosforanowany фосфатирование</p>	<p>03556</p>	<p>Mercedes-Benz Volkswagen</p> <p>universell verwendbar universal application universellement utilisable universalmente aplicable applicazione universale stosowany uniwersalnie универсальное применение</p>
 <p>Güte/Quality/qualité/calidad/qualità/ Jakość/Качество 8</p> <p>Oberfläche/Surface/surface/siperficie/ superfici/Powierzchnia/поверхность phosphatiert phosphated phosphaté fosfatar fosfatizzato fosforanowany фосфатирование</p>	<p>01214</p>	<p>Mercedes-Benz Volkswagen</p> <p>Stahl-Räder Steel-Rims Jantes en acier Llantas de acero Cerchi in acciaio Stalowe Koła Стальные диски universell verwendbar universal application universellement utilisable universalmente aplicable applicazione universale stosowany uniwersalnie универсальное применение</p>
 <p>Güte/Quality/qualité/calidad/qualità/ Jakość/Качество 10</p> <p>Oberfläche/Surface/surface/siperficie/ superfici/Powierzchnia/поверхность Zink-Nickel-beschichtet zinc-nickel-coated avec enduction étain-nickel Recubierto de cinc-níquel rivestito di zinco-nichel powłoka cynkowo-niklowa с цинко-никелевым покрытием</p>	<p>46049</p>	<p>Ford</p> <p>Stahl-Räder Steel-Rims Jantes en acier Llantas de acero Cerchi in acciaio Stalowe Koła Стальные диски</p>



 		<p>passend für: to fit: adapté à: apropiado para: adattabile per: pasuje dla: подходящий для:</p>
 <p>M14x2 SW 21 24,5</p> <p>Güte/Quality/qualité/calidad/qualità/ Jakość/Качество 10</p> <p>Oberfläche/Surface/surface/siperficie/ superfici/Powierzchnia/поверхность verzinkt galvanized galvanisé galvanizado zincato осинкованы оцинкованный</p>	<p>39371</p>	<p>Ford</p> <p>Stahl-Räder Steel-Rims Jantes en acier Llantas de acero Cerchi in acciaio Stalowe Koła Стальные диски</p>
 <p>M16x1,5 SW 24 22,5</p> <p>Güte/Quality/qualité/calidad/qualità/ Jakość/Качество 8</p> <p>Oberfläche/Surface/surface/siperficie/ superfici/Powierzchnia/поверхность phosphatiert phosphated phosphaté fosfatar fosfatizzato fosforanowany фосфатирование</p>	<p>06218</p>	<p>Ford</p> <p>Stahl-Räder Steel-Rims Jantes en acier Llantas de acero Cerchi in acciaio Stalowe Koła Стальные диски universell verwendbar universal application universellement utilisable universalmente aplicable applicazione universale stosowany uniwersalnie универсальное применение</p>
 <p>M18x1,5 SW 27 25</p> <p>Güte/Quality/qualité/calidad/qualità/ Jakość/Качество 10</p> <p>Oberfläche/Surface/surface/siperficie/ superfici/Powierzchnia/поверхность phosphatiert phosphated phosphaté fosfatar fosfatizzato fosforanowany фосфатирование</p>	<p>04899</p>	<p>Bergische Achsen IVECO MAN Volkswagen Volvo</p> <p>Stahl-Räder Steel-Rims Jantes en acier Llantas de acero Cerchi in acciaio Stalowe Koła Стальные диски universell verwendbar universal application universellement utilisable universalmente aplicable applicazione universale stosowany uniwersalnie универсальное применение</p>

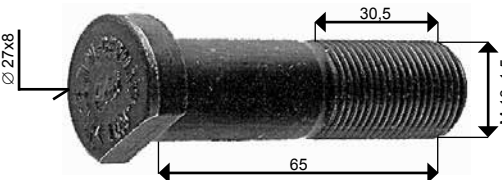
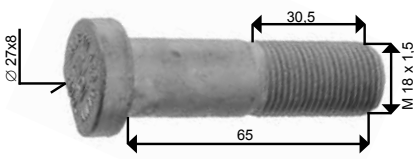
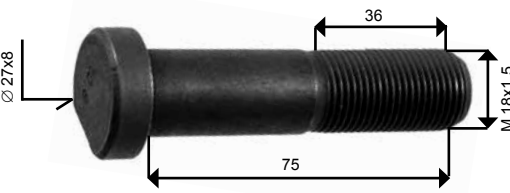
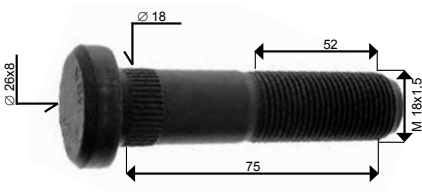

 		passend für: to fit: adapté à: apropiado para: adattabile per: pasuje dla: подходящий для:
 <p>Güte/Quality/qualité/calidad/qualità/ Jakość/Kачество 8.8</p> <p>Oberfläche/Surface/surface/siperficie/ superfici/Powierzchnia/поверхность phosphatiert phosphated phosphaté fosfatar fosfatizzato fosforanowany фосфатирование</p>	04781	Bergische Achsen
 <p>Güte/Quality/qualité/calidad/qualità/ Jakość/Kачество 10.9</p> <p>Oberfläche/Surface/surface/siperficie/ superfici/Powierzchnia/поверхность schwarz vergütet black quenched and tempered traité par trempé et revenu en noir bonificado negro bonificata nera czarny, ulepszany cieplnie с термическим воронением</p>	03176	EvoBus Mercedes-Benz
 <p>Güte/Quality/qualité/calidad/qualità/ Jakość/Kачество 10.9</p> <p>Oberfläche/Surface/surface/siperficie/ superfici/Powierzchnia/поверхность phosphatiert phosphated phosphaté fosfatar fosfatizzato fosforanowany фосфатирование</p>	01471	EvoBus Mercedes-Benz
 <p>Güte/Quality/qualité/calidad/qualità/ Jakość/Kачество 10.9</p> <p>Oberfläche/Surface/surface/siperficie/ superfici/Powierzchnia/поверхность dacromet 500</p>	32043	Mercedes-Benz

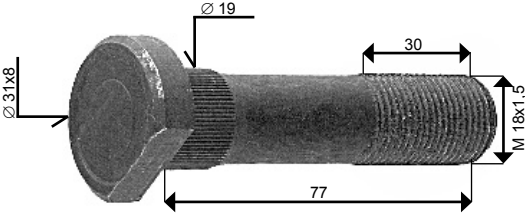
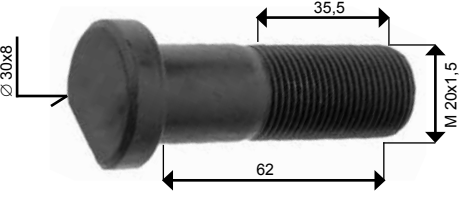
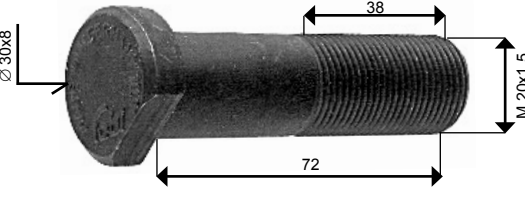
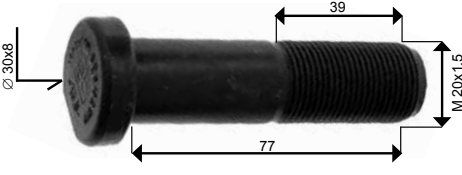

 		<p>passend für: to fit: adapté à: apropiado para: adattabile per: pasuje dla: подходящий для:</p>
 <p>Güte/Quality/qualité/calidad/qualità/ Jakość/Kачество 10.9</p> <p>Oberfläche/Surface/surface/siperficie/ superfici/Powierzchnia/поверхность phosphatiert phosphated phosphaté fosfatar fosfatzizzato fosforanowany фосфатирование</p>	<p>43572</p>	<p>DAF</p>
 <p>Güte/Quality/qualité/calidad/qualità/ Jakość/Kачество 10.9</p> <p>Oberfläche/Surface/surface/siperficie/ superfici/Powierzchnia/поверхность phosphatiert phosphated phosphaté fosfatar fosfatzizzato fosforanowany фосфатирование</p>	<p>01654</p>	<p>EvoBus Mercedes-Benz</p>
 <p>Güte/Quality/qualité/calidad/qualità/ Jakość/Kачество 10.9</p> <p>Oberfläche/Surface/surface/siperficie/ superfici/Powierzchnia/поверхность dacromet</p>	<p>12862</p>	<p>EvoBus Mercedes-Benz</p>
 <p>Güte/Quality/qualité/calidad/qualità/ Jakość/Kачество 10.9</p> <p>Oberfläche/Surface/surface/siperficie/ superfici/Powierzchnia/поверхность dacromet</p>	<p>48667</p>	<p>IVECO</p>

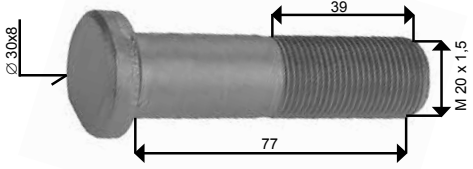
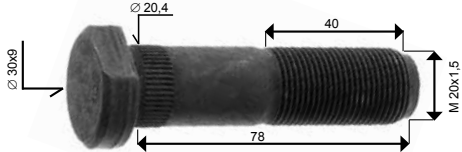
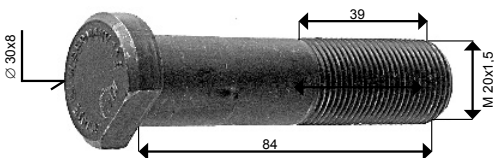
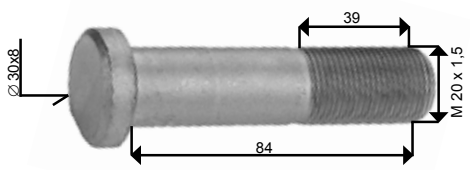

 		passend für: to fit: adapté à: apropiado para: adattabile per: pasuje dla: подходящий для:
 <p>Güte/Quality/qualité/calidad/qualità/ Jakość/Качество 10.9</p> <p>Oberfläche/Surface/surface/siperficie/ superfici/Powierzchnia/поверхность phosphatiert phosphated phosphaté fosfatar fosfatizzato fosforanowany фосфатирование</p>	01647	EvoBus Mercedes-Benz
 <p>Güte/Quality/qualité/calidad/qualità/ Jakość/Качество 10.9</p> <p>Oberfläche/Surface/surface/siperficie/ superfici/Powierzchnia/поверхность dacromet</p>	12863	EvoBus Mercedes-Benz
 <p>Güte/Quality/qualité/calidad/qualità/ Jakość/Качество 10.9</p> <p>Oberfläche/Surface/surface/siperficie/ superfici/Powierzchnia/поверхность schwarz vergütet black quenched and tempered traité par trempe et revenu en noi bonificado negro bonificata nera czarny, ulepszony cieplnie с термическим воронением</p>	09298	EvoBus Mercedes-Benz
 <p>Güte/Quality/qualité/calidad/qualità/ Jakość/Качество 10.9</p> <p>Oberfläche/Surface/surface/siperficie/ superfici/Powierzchnia/поверхность phosphatiert phosphated phosphaté fosfatar fosfatizzato fosforanowany фосфатирование</p>	46135	IVECO

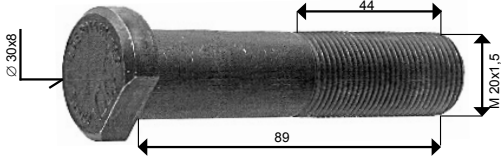
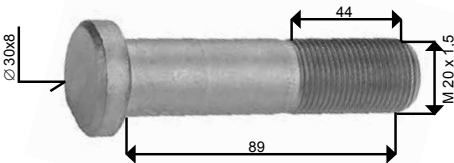
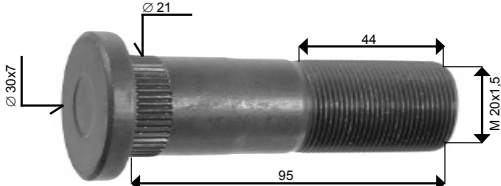
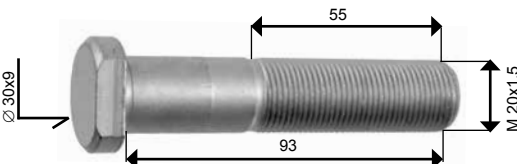

 		<p>passend für: to fit: adapté à: apropiado para: adattabile per: pasuje dla: подходящий для:</p>
 <p>Güte/Quality/qualité/calidad/qualità/ Jakość/Kачество 10.9</p> <p>Oberfläche/Surface/surface/siperficie/ superfici/Powierzchnia/поверхность phosphatiert phosphated phosphaté fosfatar fosfatizzato fosforanowany фосфатирование</p>	<p>04574</p>	<p>MAN</p>
 <p>Güte/Quality/qualité/calidad/qualità/ Jakość/Kачество 10.9</p> <p>Oberfläche/Surface/surface/siperficie/ superfici/Powierzchnia/поверхность phosphatiert phosphated phosphaté fosfatar fosfatizzato fosforanowany фосфатирование</p>	<p>01473</p>	<p>Mercedes-Benz</p>
 <p>Güte/Quality/qualité/calidad/qualità/ Jakość/Kачество 10.9</p> <p>Oberfläche/Surface/surface/siperficie/ superfici/Powierzchnia/поверхность phosphatiert phosphated phosphaté fosfatar fosfatizzato fosforanowany фосфатирование</p>	<p>03125</p>	<p>EvoBus Mercedes-Benz</p>
 <p>Güte/Quality/qualité/calidad/qualità/ Jakość/Kачество 10.9</p> <p>Oberfläche/Surface/surface/siperficie/ superfici/Powierzchnia/поверхность phosphatiert phosphated phosphaté fosfatar fosfatizzato fosforanowany фосфатирование</p>	<p>01429</p>	<p>EvoBus Mercedes-Benz</p>

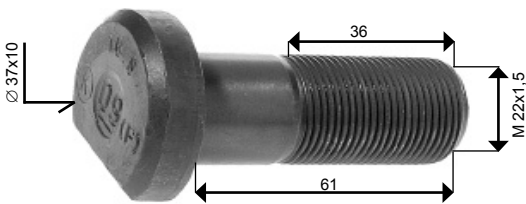
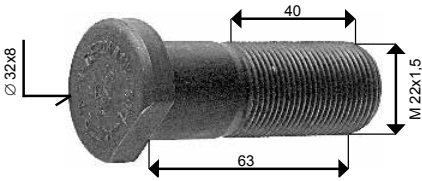
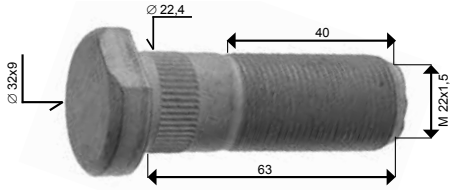
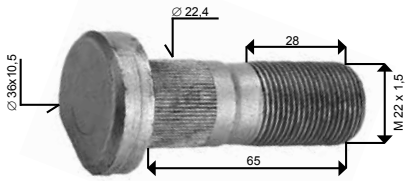

 		passend für: to fit: adapté à: apropiado para: adattabile per: pasuje dla: подходящий для:
 <p>Güte/Quality/qualité/calidad/qualità/ Jakość/Качество 10.9</p> <p>Oberfläche/Surface/surface/siperficie/ superfici/Powierzchnia/поверхность dacromet</p>	12865	EvoBus Mercedes-Benz
 <p>Güte/Quality/qualité/calidad/qualità/ Jakość/Качество 10.9</p> <p>Oberfläche/Surface/surface/siperficie/ superfici/Powierzchnia/поверхность phosphatiert phosphated phosphaté fosfatar fosfatizzato fosforanowany фосфатирующие</p>	45386	IVECO
 <p>Güte/Quality/qualité/calidad/qualità/ Jakość/Качество 10.9</p> <p>Oberfläche/Surface/surface/siperficie/ superfici/Powierzchnia/поверхность phosphatiert phosphated phosphaté fosfatar fosfatizzato fosforanowany фосфатирующие</p>	02666	EvoBus Mercedes-Benz
 <p>Güte/Quality/qualité/calidad/qualità/ Jakość/Качество 10.9</p> <p>Oberfläche/Surface/surface/siperficie/ superfici/Powierzchnia/поверхность dacromet</p>	12866	EvoBus Mercedes-Benz

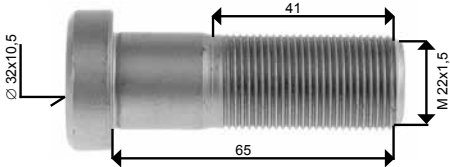
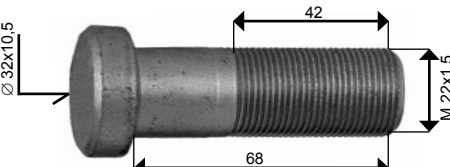
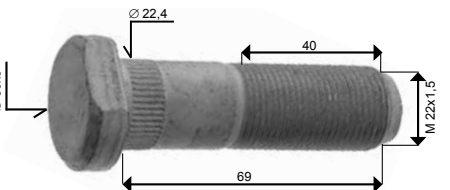
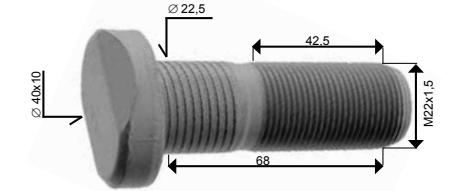

 		<p>passend für: to fit: adapté à: apropiado para: adattabile per: pasuje dla: подходящий для:</p>
 <p>Güte/Quality/qualité/calidad/qualità/ Jakość/Kачество 10.9</p> <p>Oberfläche/Surface/surface/siperficie/ superfici/Powierzchnia/поверхность phosphatiert phosphated phosphaté fosfatar fosfatizzato fosforanowany фосфатирование</p>	<p>01474</p>	<p>EvoBus Mercedes-Benz</p>
 <p>Güte/Quality/qualité/calidad/qualità/ Jakość/Kачество 10.9</p> <p>Oberfläche/Surface/surface/siperficie/ superfici/Powierzchnia/поверхность dacromet</p>	<p>12867</p>	<p>Evobus Mercedes-Benz</p>
 <p>Güte/Quality/qualité/calidad/qualità/ Jakość/Kачество 10.9</p> <p>Oberfläche/Surface/surface/siperficie/ superfici/Powierzchnia/поверхность phosphatiert phosphated phosphaté fosfatar fosfatizzato fosforanowany фосфатирование</p>	<p>18826</p>	<p>RENAULT TRUCKS</p>
 <p>Güte/Quality/qualité/calidad/qualità/ Jakość/Kачество 10.9</p> <p>Oberfläche/Surface/surface/siperficie/ superfici/Powierzchnia/поверхность dacromet</p>	<p>21583</p>	<p>Mercedes-Benz</p>

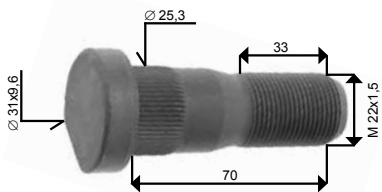
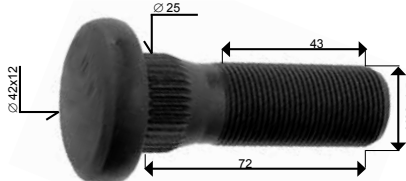
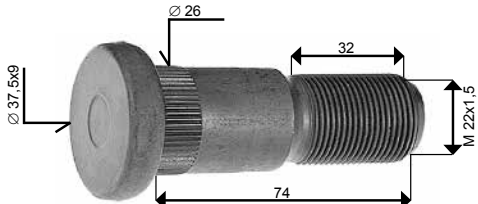
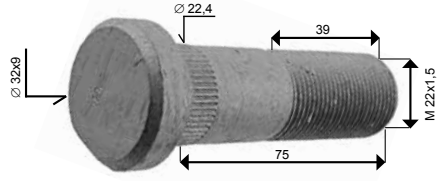

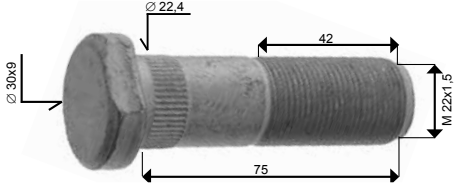
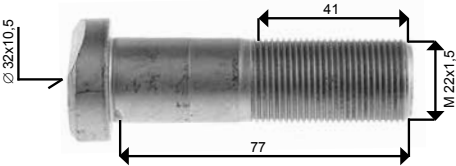
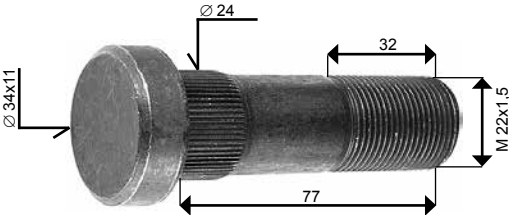
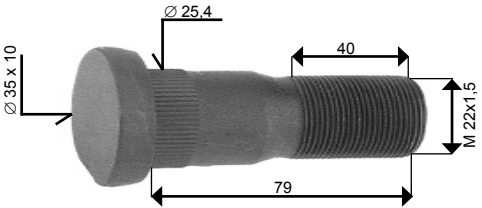

 		passend für: to fit: adapté à: apropiado para: adattabile per: pasuje dla: подходящий для:
 <p>Güte/Quality/qualité/calidad/qualità/ Jakość/Качество 10.9</p> <p>Oberfläche/Surface/surface/siperficie/ superfici/Powierzchnia/поверхность phosphatiert phosphated phosphaté fosfatar fosfatizzato fosforanowany фосфатирование</p>	19331	EvoBus Mercedes-Benz Setra
 <p>Güte/Quality/qualité/calidad/qualità/ Jakość/Качество 10.9</p> <p>Oberfläche/Surface/surface/siperficie/ superfici/Powierzchnia/поверхность phosphatiert phosphated phosphaté fosfatar fosfatizzato fosforanowany фосфатирование</p>	01648	EvoBus Mercedes-Benz Setra
 <p>Güte/Quality/qualité/calidad/qualità/ Jakość/Качество 10.9</p> <p>Oberfläche/Surface/surface/siperficie/ superfici/Powierzchnia/поверхность dacromet</p>	45383	IVECO
 <p>Güte/Quality/qualité/calidad/qualità/ Jakość/Качество 10.9</p> <p>Oberfläche/Surface/surface/siperficie/ superfici/Powierzchnia/поверхность dacromet</p>	15170	MAN NEOPLAN

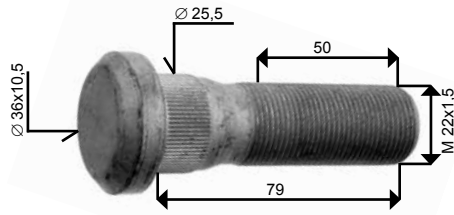
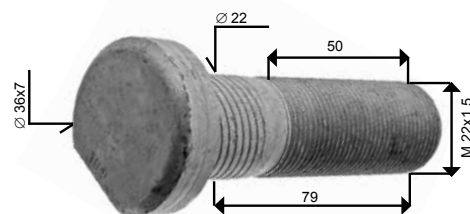
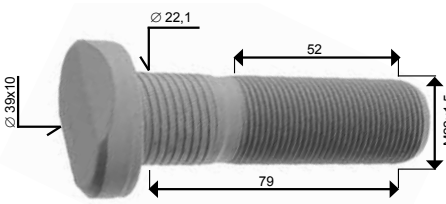
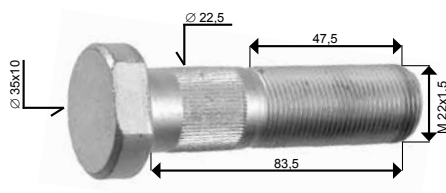

 		<p>passend für: to fit: adapté à: apropiado para: adattabile per: pasuje dla: подходящий для:</p>
 <p>Güte/Quality/qualité/calidad/qualità/ Jakość/Качество 10.9</p> <p>Oberfläche/Surface/surface/siperficie/ superfici/Powierzchnia/поверхность dacromet</p>	<p>14039</p>	<p>EvoBus Mercedes-Benz</p>
 <p>Güte/Quality/qualité/calidad/qualità/ Jakość/Качество 10.9</p> <p>Oberfläche/Surface/surface/siperficie/ superfici/Powierzchnia/поверхность dacromet</p>	<p>05524</p>	<p>EvoBus Mercedes-Benz Setra</p>
 <p>Güte/Quality/qualité/calidad/qualità/ Jakość/Качество 10.9</p> <p>Oberfläche/Surface/surface/siperficie/ superfici/Powierzchnia/поверхность dacromet</p>	<p>45381</p>	<p>IVECO</p>
 <p>Güte/Quality/qualité/calidad/qualità/ Jakość/Качество 10.9</p> <p>Oberfläche/Surface/surface/siperficie/ superfici/Powierzchnia/поверхность geomet</p>	<p>48706</p>	<p>Mercedes-Benz</p>

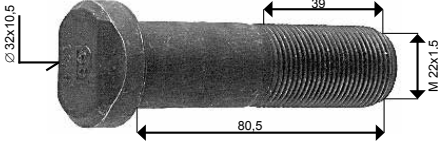
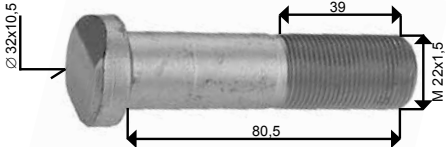

 		passend für: to fit: adapté à: apropiado para: adattabile per: pasuje dla: подходящий для:
 <p>Güte/Quality/qualité/calidad/qualità/ Jakość/Качество 10.9</p> <p>Oberfläche/Surface/surface/siperficie/ superfici/Powierzchnia/поверхность phosphatiert phosphated phosphaté fosfatar fosfatizzato fosforanowany фосфатирование</p>	<p>27796</p>	<p>RENAULT TRUCKS</p>
 <p>Güte/Quality/qualité/calidad/qualità/ Jakość/Качество 10.9</p> <p>Oberfläche/Surface/surface/siperficie/ superfici/Powierzchnia/поверхность phosphatiert phosphated phosphaté fosfatar fosfatizzato fosforanowany фосфатирование</p>	<p>40036</p>	<p>DAF</p>
 <p>Güte/Quality/qualité/calidad/qualità/ Jakość/Качество 10.9</p> <p>Oberfläche/Surface/surface/siperficie/ superfici/Powierzchnia/поверхность phosphatiert phosphated phosphaté fosfatar fosfatizzato fosforanowany фосфатирование</p>	<p>07312</p>	<p>Fruehauf Trailor</p>
 <p>Güte/Quality/qualité/calidad/qualità/ Jakość/Качество 10.9</p> <p>Oberfläche/Surface/surface/siperficie/ superfici/Powierzchnia/поверхность dacromet</p>	<p>45385</p>	<p>IVECO</p>

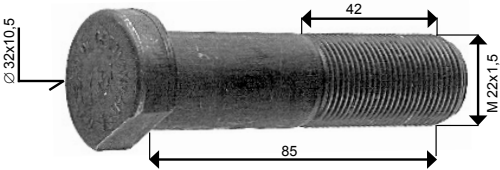

 		<p>passend für: to fit: adapté à: apropiado para: adattabile per: pasuje dla: подходящий для:</p>
 <p>Güte/Quality/qualité/calidad/qualità/ Jakość/Kачество 10.9</p> <p>Oberfläche/Surface/surface/siperficie/ superfici/Powierzchnia/поверхность dacromet</p>	<p>45382</p>	<p>IVECO</p>
 <p>Güte/Quality/qualité/calidad/qualità/ Jakość/Kачество 10.9</p> <p>Oberfläche/Surface/surface/siperficie/ superfici/Powierzchnia/поверхность dacromet</p>	<p>14041</p>	<p>EvoBus MAN Mercedes-Benz Setra</p>
 <p>Güte/Quality/qualité/calidad/qualità/ Jakość/Kачество 10.9</p> <p>Oberfläche/Surface/surface/siperficie/ superfici/Powierzchnia/поверхность phosphatiert phosphated phosphaté fosfatar fosfatizzato fosforanowany фосфатирование</p>	<p>04487</p>	<p>Volvo</p>
 <p>Güte/Quality/qualité/calidad/qualità/ Jakość/Kачество 10.9</p> <p>Oberfläche/Surface/surface/siperficie/ superfici/Powierzchnia/поверхность phosphatiert phosphated phosphaté fosfatar fosfatizzato fosforanowany фосфатирование</p>	<p>10445</p>	<p>RENAULT TRUCKS</p>

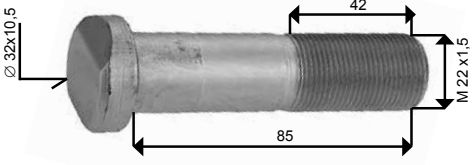
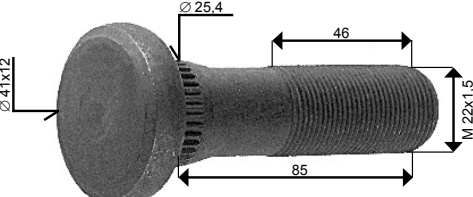
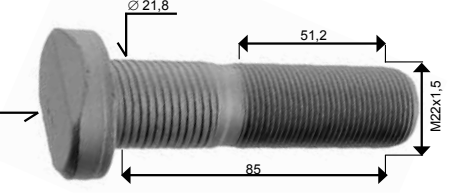
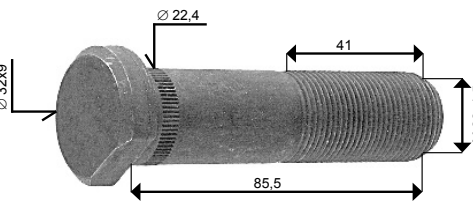
 		passend für: to fit: adapté à: apropiado para: adattabile per: pasuje dla: подходящий для:
 <p>Güte/Quality/qualité/calidad/qualità/ Jakość/Качество 10.9</p> <p>Oberfläche/Surface/surface/siperficie/ superfici/Powierzchnia/поверхность geomet</p>	32796	RENAULT TRUCKS Volvo
 <p>Güte/Quality/qualité/calidad/qualità/ Jakość/Качество 10.9</p> <p>Oberfläche/Surface/surface/siperficie/ superfici/Powierzchnia/поверхность dacromet 500</p>	44322	EvoBus MAN Mercedes-Benz
 <p>Güte/Quality/qualité/calidad/qualità/ Jakość/Качество 10.9</p> <p>Oberfläche/Surface/surface/siperficie/ superfici/Powierzchnia/поверхность geomet</p>	48707	Mercedes-Benz
 <p>Güte/Quality/qualité/calidad/qualità/ Jakość/Качество 10.9</p> <p>Oberfläche/Surface/surface/siperficie/ superfici/Powierzchnia/поверхность geomet</p>	02406	SAF

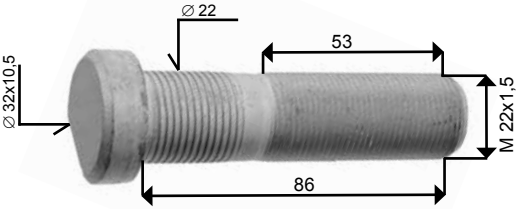
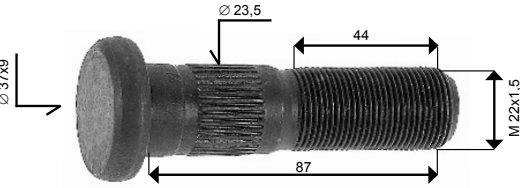
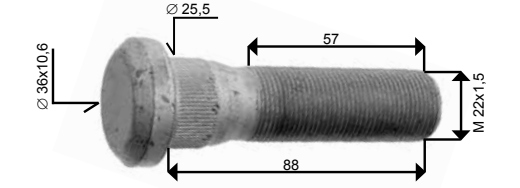
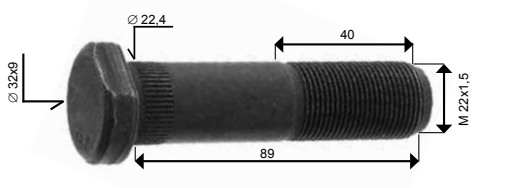

 		<p>passend für: to fit: adapté à: apropiado para: adattabile per: pasuje dla: подходящий для:</p>
 <p>Güte/Quality/qualité/calidad/qualità/ Jakość/Kачество 10.9</p> <p>Oberfläche/Surface/surface/siperficie/ superfici/Powierzchnia/поверхность phosphatiert phosphated phosphaté fosfatar fosfatizzato fosforanowany фосфатирование</p>	<p>03997</p>	<p>EvoBus MAN Mercedes-Benz</p>
 <p>Güte/Quality/qualité/calidad/qualità/ Jakość/Kачество 10.9</p> <p>Oberfläche/Surface/surface/siperficie/ superfici/Powierzchnia/поверхность dacromet</p>	<p>12868</p>	<p>EvoBus MAN Mercedes-Benz Neoplan</p>
 <p>Güte/Quality/qualité/calidad/qualità/ Jakość/Kачество 10.9</p> <p>Oberfläche/Surface/surface/siperficie/ superfici/Powierzchnia/поверхность phosphatiert phosphated phosphaté fosfatar fosfatizzato fosforanowany фосфатирование</p>	<p>18693</p>	<p>MAN NEOPLAN</p>
 <p>Güte/Quality/qualité/calidad/qualità/ Jakość/Kачество 10.9</p> <p>Oberfläche/Surface/surface/siperficie/ superfici/Powierzchnia/поверхность phosphatiert phosphated phosphaté fosfatar fosfatizzato fosforanowany фосфатирование</p>	<p>07940</p>	<p>EvoBus Mercedes-Benz Setra</p>

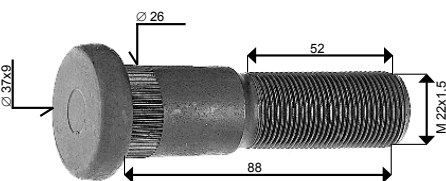
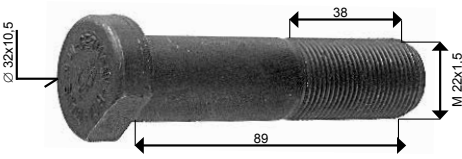
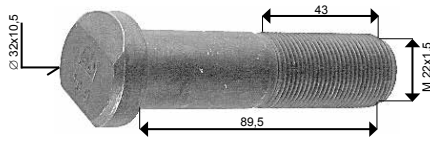
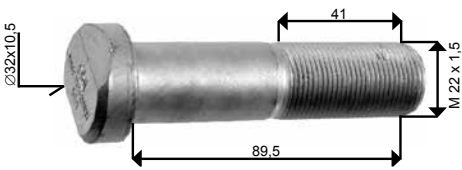

 		passend für: to fit: adapté à: apropiado para: adattabile per: pasuje dla: подходящий для:
 <p>Güte/Quality/qualité/calidad/qualità/ Jakość/Kачество 10.9</p> <p>Oberfläche/Surface/surface/siperficie/ superfici/Powierzchnia/поверхность dacromet</p>	<p>12869</p>	<p>EvoBus Mercedes-Benz Setra</p>
 <p>Güte/Quality/qualité/calidad/qualità/ Jakość/Kачество 10.9</p> <p>Oberfläche/Surface/surface/siperficie/ superfici/Powierzchnia/поверхность phosphatiert phosphated phosphaté fosfatar fosfatizzato fosforanowany фосфатирование</p>	<p>08442</p>	<p>DAF</p>
 <p>Güte/Quality/qualité/calidad/qualità/ Jakość/Kачество 10.9</p> <p>Oberfläche/Surface/surface/siperficie/ superfici/Powierzchnia/поверхность geomet</p>	<p>48708</p>	<p>Mercedes-Benz</p>
 <p>Güte/Quality/qualité/calidad/qualità/ Jakość/Kачество 10.9</p> <p>Oberfläche/Surface/surface/siperficie/ superfici/Powierzchnia/поверхность phosphatiert phosphated phosphaté fosfatar fosfatizzato fosforanowany фосфатирование</p>	<p>05317</p>	<p>IVECO</p>



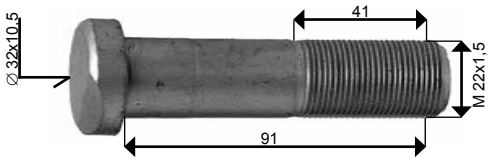
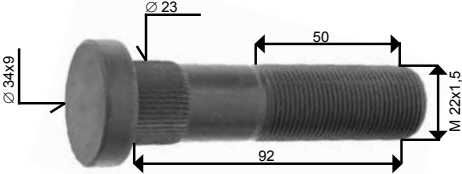
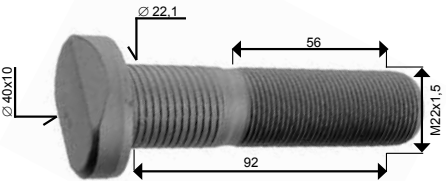
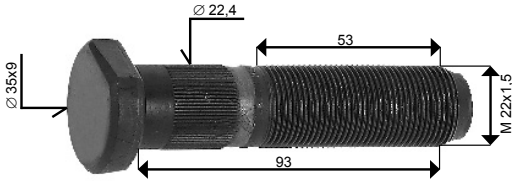

 		<p>passend für: to fit: adapté à: apropiado para: adattabile per: pasuje dla: подходящий для:</p>
 <p>Güte/Quality/qualité/calidad/qualità/ Jakość/Качество 10.9</p> <p>Oberfläche/Surface/surface/siperficie/ superfici/Powierzchnia/поверхность dacromet</p>	<p>29418</p>	<p>EvoBus Mercedes-Benz</p>
 <p>Güte/Quality/qualité/calidad/qualità/ Jakość/Качество 10.9</p> <p>Oberfläche/Surface/surface/siperficie/ superfici/Powierzchnia/поверхность phosphatiert phosphated phosphaté fosfatar fosfatizzato fosforanowany фосфатирование</p>	<p>02504</p>	<p>ROR</p>
 <p>Güte/Quality/qualité/calidad/qualità/ Jakość/Качество 10.9</p> <p>Oberfläche/Surface/surface/siperficie/ superfici/Powierzchnia/поверхность geomet</p>	<p>32797</p>	<p>RENAULT TRUCKS Volvo</p>
 <p>Güte/Quality/qualité/calidad/qualità/ Jakość/Качество 10.9</p> <p>Oberfläche/Surface/surface/siperficie/ superfici/Powierzchnia/поверхность phosphatiert phosphated phosphaté fosfatar fosfatizzato fosforanowany фосфатирование</p>	<p>45387</p>	<p>IVECO</p>

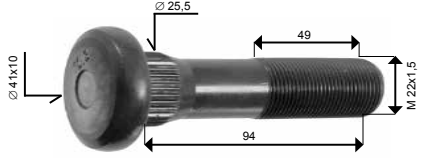
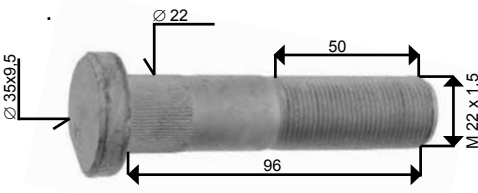
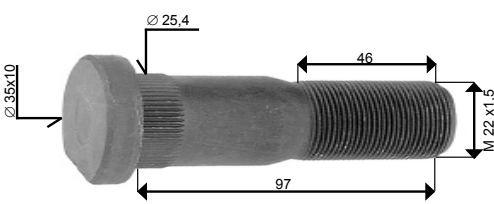
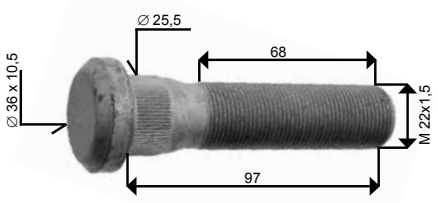

 		passend für: to fit: adapté à: apropiado para: adattabile per: pasuje dla: подходящий для:
 <p>Güte/Quality/qualité/calidad/qualità/ Jakość/Качество 10.9</p> <p>Oberfläche/Surface/surface/siperficie/ superfici/Powierzchnia/поверхность geomet</p>	07304	Fruehauf Trailor
 <p>Güte/Quality/qualité/calidad/qualità/ Jakość/Качество 10.9</p> <p>Oberfläche/Surface/surface/siperficie/ superfici/Powierzchnia/поверхность phosphatiert phosphated phosphaté fosfatar fosfatizzato fosforanowany фосфатирование</p>	03958	EvoBus MAN Mercedes-Benz
 <p>Güte/Quality/qualité/calidad/qualità/ Jakość/Качество 10.9</p> <p>Oberfläche/Surface/surface/siperficie/ superfici/Powierzchnia/поверхность phosphatiert phosphated phosphaté fosfatar fosfatizzato fosforanowany фосфатирование</p>	07944	EvoBus Mercedes-Benz
 <p>Güte/Quality/qualité/calidad/qualità/ Jakość/Качество 10.9</p> <p>Oberfläche/Surface/surface/siperficie/ superfici/Powierzchnia/поверхность dacromet</p>	12870	Mercedes-Benz EvoBus



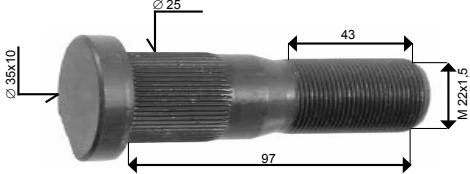

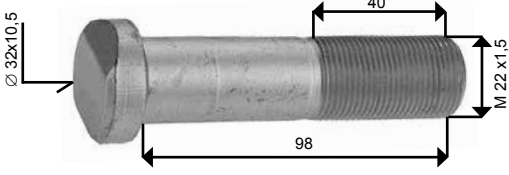
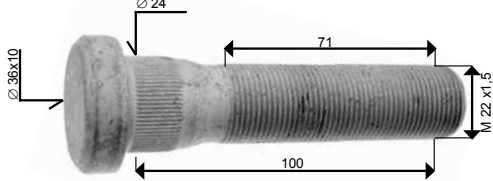

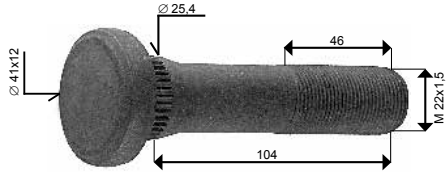
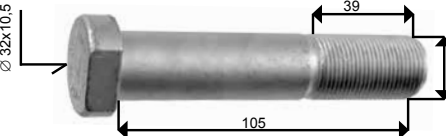
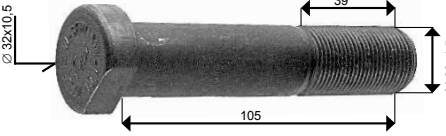
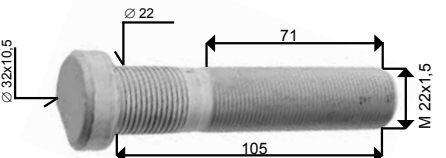

 		<p>passend für: to fit: adapté à: apropiado para: adattabile per: pasuje dla: подходящий для:</p>
 <p>Güte/Quality/qualité/calidad/qualità/ Jakość/Kачество 10.9</p> <p>Oberfläche/Surface/surface/siperficie/ superfici/Powierzchnia/поверхность geomet</p>	<p>05530</p>	<p>EvoBus Mercedes-Benz</p>
 <p>Güte/Quality/qualité/calidad/qualità/ Jakość/Kачество 10.9</p> <p>Oberfläche/Surface/surface/siperficie/ superfici/Powierzchnia/поверхность phosphatiert phosphated phosphaté fosfatar fosfatizzato fosforanowany фосфатирование</p>	<p>15341</p>	<p>NEOPLAN IVECO</p>
 <p>Güte/Quality/qualité/calidad/qualità/ Jakość/Kачество 10.9</p> <p>Oberfläche/Surface/surface/siperficie/ superfici/Powierzchnia/поверхность geomet</p>	<p>48710</p>	<p>Mercedes-Benz</p>
 <p>Güte/Quality/qualité/calidad/qualità/ Jakość/Kачество 10.9</p> <p>Oberfläche/Surface/surface/siperficie/ superfici/Powierzchnia/поверхность geomet</p>	<p>02407</p>	<p>SAF</p>



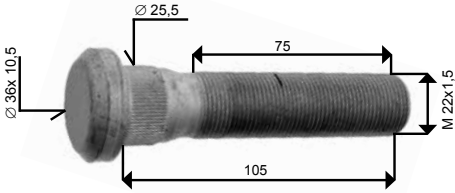
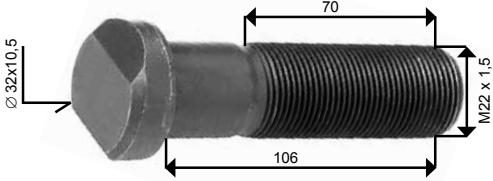
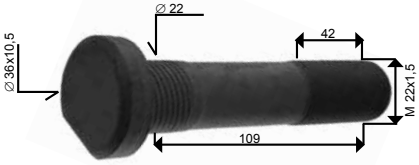
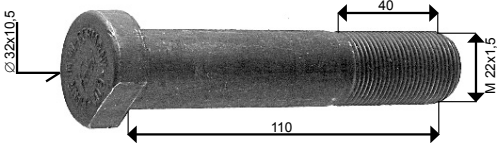

 		passend für: to fit: adapté à: apropiado para: adattabile per: pasuje dla: подходящий для:
 <p>Güte/Quality/qualité/calidad/qualità/ Jakość/Качество 10.9</p> <p>Oberfläche/Surface/surface/siperficie/ superfici/Powierzchnia/поверхность phosphatiert phosphated phosphaté fosfatar fosfatizzato fosforanowany фосфатирование</p>	<p>15760</p>	<p>DAF</p>
 <p>Güte/Quality/qualité/calidad/qualità/ Jakość/Качество 10.9</p> <p>Oberfläche/Surface/surface/siperficie/ superfici/Powierzchnia/поверхность dacromet</p>	<p>24397</p>	<p>Volvo</p>
 <p>Güte/Quality/qualité/calidad/qualità/ Jakość/Качество 10.9</p> <p>Oberfläche/Surface/surface/siperficie/ superfici/Powierzchnia/поверхность phosphatiert phosphated phosphaté fosfatar fosfatizzato fosforanowany фосфатирование</p>	<p>10444</p>	<p>RENAULT TRUCKS</p>
 <p>Güte/Quality/qualité/calidad/qualità/ Jakość/Качество 10.9</p> <p>Oberfläche/Surface/surface/siperficie/ superfici/Powierzchnia/поверхность geomet</p>	<p>32798</p>	<p>RENAULT TRUCKS Volvo</p>

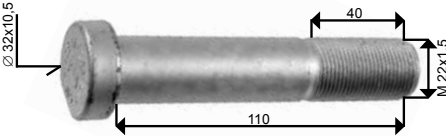
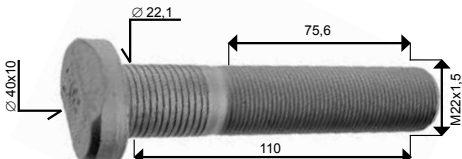
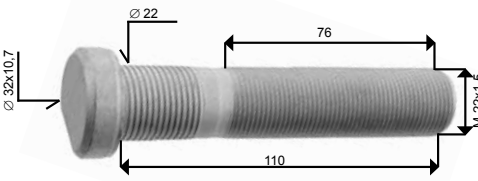
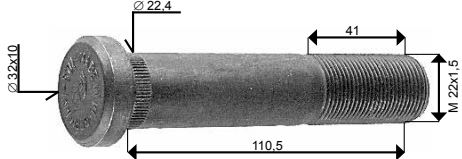

 		<p>passend für: to fit: adapté à: apropiado para: adattabile per: pasuje dla: подходящий для:</p>
 <p>Güte/Quality/qualité/calidad/qualità/ Jakość/Kачество 10.9 Oberfläche/Surface/surface/superficie/ superfici/Powierzchnia/поверхность phosphatiert phosphated phosphaté fosfatar fosfatizzato fosforanowany фосфатирование</p>	<p>18825</p>	<p>RENAULT TRUCKS</p>
 <p>Güte/Quality/qualité/calidad/qualità/ Jakość/Kачество 10.9 Oberfläche/Surface/surface/superficie/ superfici/Powierzchnia/поверхность phosphatiert phosphated phosphaté fosfatar fosfatizzato fosforanowany фосфатирование</p>	<p>03960</p>	<p>EvoBus MAN Mercedes-Benz</p>
 <p>Güte/Quality/qualité/calidad/qualità/ Jakość/Kачество 10.9 Oberfläche/Surface/surface/superficie/ superfici/Powierzchnia/поверхность dacromet</p>	<p>12871</p>	<p>EvoBus MAN Mercedes-Benz</p>
 <p>Güte/Quality/qualité/calidad/qualità/ Jakość/Kачество 10.9 Oberfläche/Surface/surface/superficie/ superfici/Powierzchnia/поверхность phosphatiert phosphated phosphaté fosfatar fosfatizzato fosforanowany фосфатирование</p>	<p>44311</p>	<p>Renault Truck Volvo</p>

 		passend für: to fit: adapté à: apropiado para: adattabile per: pasuje dla: подходящий для:
 <p>Güte/Quality/qualité/calidad/qualità/ Jakość/Качество 10.9</p> <p>Oberfläche/Surface/surface/siperficie/ superfici/Powierzchnia/поверхность phosphatiert phosphated phosphaté fosfatar fosfatizzato fosforanowany фосфатирование</p>	08443	DAF
 <p>Güte/Quality/qualité/calidad/qualità/ Jakość/Качество 10.9</p> <p>Oberfläche/Surface/surface/siperficie/ superfici/Powierzchnia/поверхность dacromet</p>	12872	EvoBus MAN Mercedes-Benz
 <p>Güte/Quality/qualité/calidad/qualità/ Jakość/Качество 10.9</p> <p>Oberfläche/Surface/surface/siperficie/ superfici/Powierzchnia/поверхность phosphatiert phosphated phosphaté fosfatar fosfatizzato fosforanowany фосфатирование</p>	03552	EvoBus MAN Mercedes-Benz Setra
 <p>Güte/Quality/qualité/calidad/qualità/ Jakość/Качество 10.9</p> <p>Oberfläche/Surface/surface/siperficie/ superfici/Powierzchnia/поверхность geomet</p>	29942	EvoBus Mercedes-Benz Setra

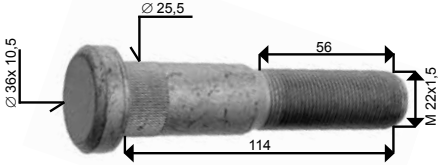
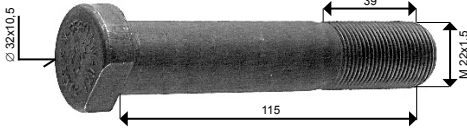

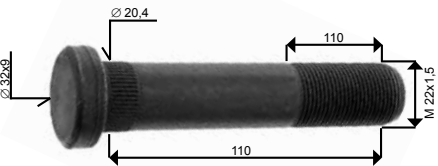
 		<p>passend für: to fit: adapté à: apropiado para: adattabile per: pasuje dla: подходящий для:</p>
 <p>Güte/Quality/qualité/calidad/qualità/ Jakość/Kачество 10.9</p> <p>Oberfläche/Surface/surface/siperficie/ superfici/Powierzchnia/поверхность geomet</p>	<p>32799</p>	<p>RENAULT TRUCKS Volvo</p>
 <p>Güte/Quality/qualité/calidad/qualità/ Jakość/Kачество 10.9</p> <p>Oberfläche/Surface/surface/siperficie/ superfici/Powierzchnia/поверхность phosphatiert phosphated phosphaté fosfatar fosfatizzato fosforanowany фосфатирование</p>	<p>18694</p>	<p>MAN NEOPLAN</p>
 <p>Güte/Quality/qualité/calidad/qualità/ Jakość/Kачество 10.9</p> <p>Oberfläche/Surface/surface/siperficie/ superfici/Powierzchnia/поверхность dacromet 500</p>	<p>43538</p>	<p>MAN</p>
 <p>Güte/Quality/qualité/calidad/qualità/ Jakość/Kачество 10.9</p> <p>Oberfläche/Surface/surface/siperficie/ superfici/Powierzchnia/поверхность phosphatiert phosphated phosphaté fosfatar fosfatizzato fosforanowany фосфатирование</p>	<p>03740</p>	<p>EvoBus MAN Mercedes-Benz</p>

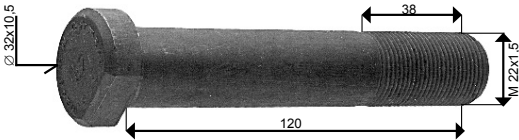
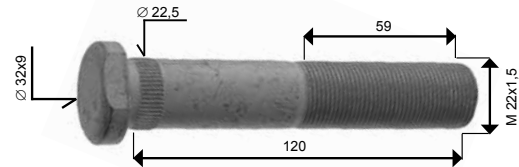
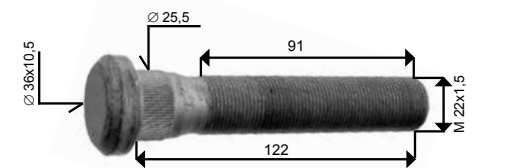
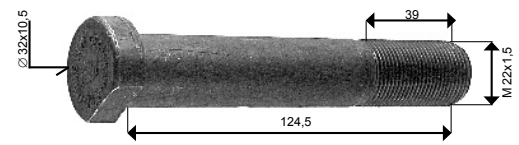

 		passend für: to fit: adapté à: apropiado para: adattabile per: pasuje dla: подходящий для:
 <p>Güte/Quality/qualité/calidad/qualità/ Jakość/Качество 10.9</p> <p>Oberfläche/Surface/surface/siperficie/ superfici/Powierzchnia/поверхность dacromet</p>	12873	EvoBus MAN Mercedes-Benz
 <p>Güte/Quality/qualité/calidad/qualità/ Jakość/Качество 10.9</p> <p>Oberfläche/Surface/surface/siperficie/ superfici/Powierzchnia/поверхность geomet</p>	48709	Mercedes-Benz
 <p>Güte/Quality/qualité/calidad/qualità/ Jakość/Качество 10.9</p> <p>Oberfläche/Surface/surface/siperficie/ superfici/Powierzchnia/поверхность geomet</p>	29943	EvoBus Mercedes-Benz
 <p>Güte/Quality/qualité/calidad/qualità/ Jakość/Качество 10.9</p> <p>Oberfläche/Surface/surface/siperficie/ superfici/Powierzchnia/поверхность phosphatiert phosphated phosphaté fosfatar fosfatizzato fosforanowany фосфатирование</p>	04573	IVECO



 		<p>passend für: to fit: adapté à: apropiado para: adattabile per: pasuje dla: подходящий для:</p>
 <p>Güte/Quality/qualité/calidad/qualità/ Jakość/Kачество 10.9</p> <p>Oberfläche/Surface/surface/siperficie/ superfici/Powierzchnia/поверхность dacromet 500</p>	<p>32801</p>	<p>RENAULT TRUCKS Volvo</p>
 <p>Güte/Quality/qualité/calidad/qualità/ Jakość/Kачество 10.9</p> <p>Oberfläche/Surface/surface/siperficie/ superfici/Powierzchnia/поверхность phosphatiert phosphated phosphaté fosfatar fosfatizzato fosforanowany фосфатирование</p>	<p>03961</p>	<p>Evobus MAN Mercedes-Benz</p>
 <p>Güte/Quality/qualité/calidad/qualità/ Jakość/Kачество 10.9</p> <p>Oberfläche/Surface/surface/siperficie/ superfici/Powierzchnia/поверхность dacromet</p>	<p>12874</p>	<p>EvoBus Mercedes-Benz</p>
 <p>Güte/Quality/qualité/calidad/qualità/ Jakość/Kачество 10.9</p> <p>Oberfläche/Surface/surface/siperficie/ superfici/Powierzchnia/поверхность phosphatiert phosphated phosphaté fosfatar fosfatizzato fosforanowany фосфатирование</p>	<p>35631</p>	<p>IVECO</p>

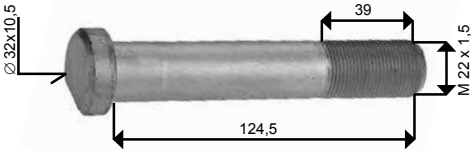
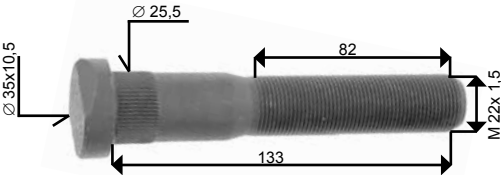
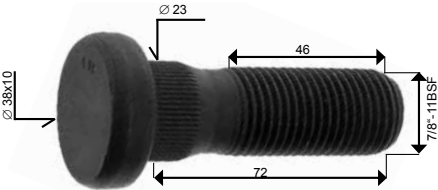
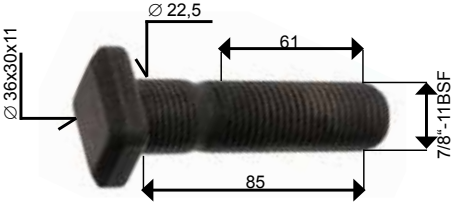

 		passend für: to fit: adapté à: apropiado para: adattabile per: pasuje dla: подходящий для:
 <p>Güte/Quality/qualité/calidad/qualità/ Jakość/Качество 10.9</p> <p>Oberfläche/Surface/surface/siperficie/ superfici/Powierzchnia/поверхность phosphatiert phosphated phosphaté fosfatar fosfatizzato fosforowany фосфатирование</p>	<p>03962</p>	<p>MAN</p>
 <p>Güte/Quality/qualité/calidad/qualità/ Jakość/Качество 10.9</p> <p>Oberfläche/Surface/surface/siperficie/ superfici/Powierzchnia/поверхность dacromet</p>	<p>45384</p>	<p>IVECO</p>
 <p>Güte/Quality/qualité/calidad/qualità/ Jakość/Качество 10.9</p> <p>Oberfläche/Surface/surface/siperficie/ superfici/Powierzchnia/поверхность dacromet 500</p>	<p>32800</p>	<p>RENAULT TRUCKS Volvo</p>
 <p>Güte/Quality/qualité/calidad/qualità/ Jakość/Качество 10.9</p> <p>Oberfläche/Surface/surface/siperficie/ superfici/Powierzchnia/поверхность phosphatiert phosphated phosphaté fosfatar fosfatizzato fosforowany фосфатирование</p>	<p>07953</p>	<p>Mercedes-Benz</p>

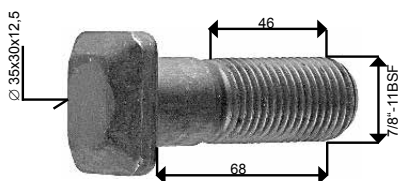
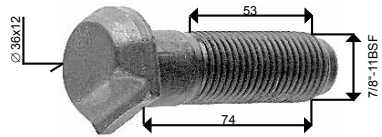
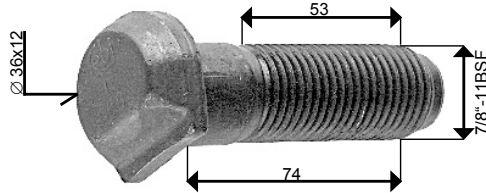
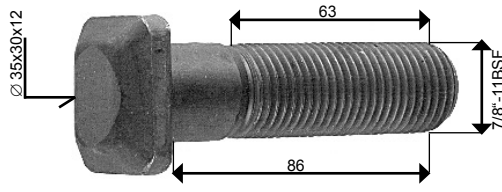

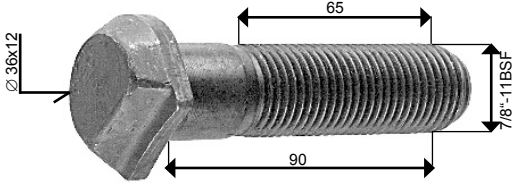
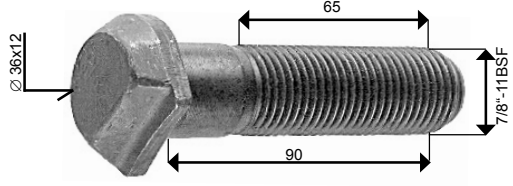
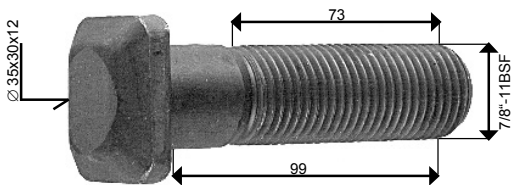
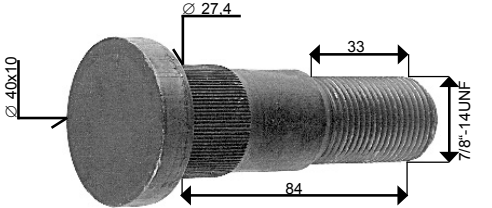

 		passend für: to fit: adapté à: apropiado para: adattabile per: pasuje dla: подходящий для:
 <p>Güte/Quality/qualité/calidad/qualità/ Jakość/Качество 10.9</p> <p>Oberfläche/Surface/surface/siperficie/ superfici/Powierzchnia/поверхность dacromet</p>	12875	Mercedes-Benz
 <p>Güte/Quality/qualité/calidad/qualità/ Jakość/Качество 10.9</p> <p>Oberfläche/Surface/surface/siperficie/ superfici/Powierzchnia/поверхность phosphatiert phosphated phosphaté fosfatar fosfatzizzato fosforanowany фосфатирование</p>	24779	RENAULT TRUCKS
 <p>Güte/Quality/qualité/calidad/qualità/ Jakość/Качество 10.9</p> <p>Oberfläche/Surface/surface/siperficie/ superfici/Powierzchnia/поверхность phosphatiert phosphated phosphaté fosfatar fosfatzizzato fosforanowany фосфатирование</p>	40510	Scania
 <p>Güte/Quality/qualité/calidad/qualità/ Jakość/Качество 10.9</p> <p>Oberfläche/Surface/surface/siperficie/ superfici/Powierzchnia/поверхность phosphatiert phosphated phosphaté fosfatar fosfatzizzato fosforanowany фосфатирование RHT</p>	14853	Scania

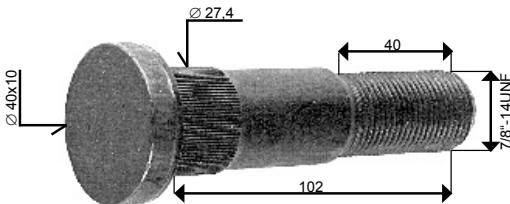
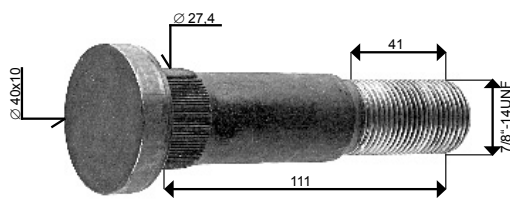
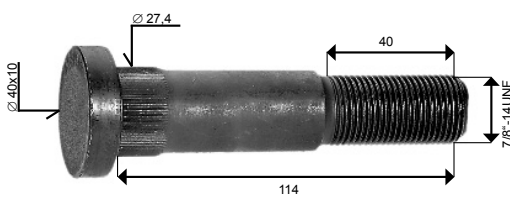

 		passend für: to fit: adapté à: apropiado para: adattabile per: pasuje dla: подходящий для:
 <p>Güte/Quality/qualité/calidad/qualità/ Jakość/Качество 10.9</p> <p>Oberfläche/Surface/surface/siperficie/ superfici/Powierzchnia/поверхность phosphatiert phosphated phosphaté fosfatar fosfatizzato fosforanowany фосфатирование RHT</p>	05916	Scania
 <p>Güte/Quality/qualité/calidad/qualità/ Jakość/Качество 10.9</p> <p>Oberfläche/Surface/surface/siperficie/ superfici/Powierzchnia/поверхность phosphatiert phosphated phosphaté fosfatar fosfatizzato fosforanowany фосфатирование LHT</p>	03842	Scania
 <p>Güte/Quality/qualité/calidad/qualità/ Jakość/Качество 10.9</p> <p>Oberfläche/Surface/surface/siperficie/ superfici/Powierzchnia/поверхность phosphatiert phosphated phosphaté fosfatar fosfatizzato fosforanowany фосфатирование RHT</p>	03843	Scania
 <p>Güte/Quality/qualité/calidad/qualità/ Jakość/Качество 10.9</p> <p>Oberfläche/Surface/surface/siperficie/ superfici/Powierzchnia/поверхность phosphatiert phosphated phosphaté fosfatar fosfatizzato fosforanowany фосфатирование RHT</p>	05917	Scania

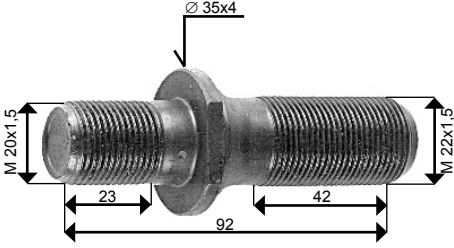
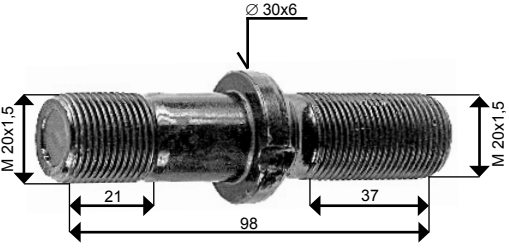
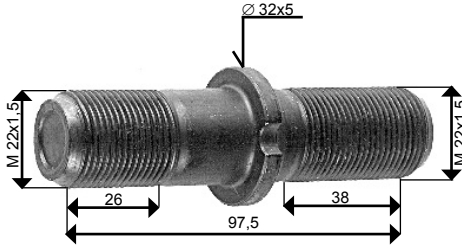
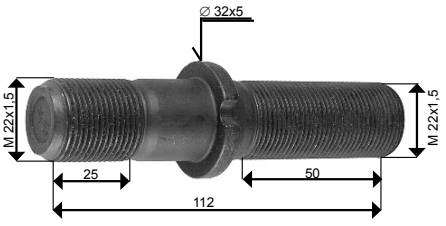

 		passend für: to fit: adapté à: apropiado para: adattabile per: pasuje dla: подходящий для:
 <p>Güte/Quality/qualité/calidad/qualità/ Jakość/Kачество 10.9</p> <p>Oberfläche/Surface/surface/siperficie/ superfici/Powierzchnia/поверхность phosphatiert phosphated phosphaté fosfatar fosfatzizzato fosforanowany фосфатирование LHT</p>	03844	Scania
 <p>Güte/Quality/qualité/calidad/qualità/ Jakość/Kачество 10.9</p> <p>Oberfläche/Surface/surface/siperficie/ superfici/Powierzchnia/поверхность phosphatiert phosphated phosphaté fosfatar fosfatzizzato fosforanowany фосфатирование RHT</p>	03845	Scania
 <p>Güte/Quality/qualité/calidad/qualità/ Jakość/Kачество 10.9</p> <p>Oberfläche/Surface/surface/siperficie/ superfici/Powierzchnia/поверхность phosphatiert phosphated phosphaté fosfatar fosfatzizzato fosforanowany фосфатирование RHT</p>	05915	Scania
 <p>Güte/Quality/qualité/calidad/qualità/ Jakość/Kачество 10.9</p> <p>Oberfläche/Surface/surface/siperficie/ superfici/Powierzchnia/поверхность phosphatiert phosphated phosphaté fosfatar fosfatzizzato fosforanowany фосфатирование</p>	05779	Volvo

 		passend für: to fit: adapté à: apropiado para: adattabile per: pasuje dla: подходящий для:
 <p> Güte/Quality/qualité/calidad/qualità/ Jakość/Качество 10.9 Oberfläche/Surface/surface/siperficie/ superfici/Powierzchnia/поверхность phosphatiert phosphated phosphaté fosfatar fosfatizzato fosforanowany фосфатирование </p>	<p>05778</p>	<p>Volvo</p>
 <p> Güte/Quality/qualité/calidad/qualità/ Jakość/Качество 8.8 Oberfläche/Surface/surface/siperficie/ superfici/Powierzchnia/поверхность phosphatiert phosphated phosphaté fosfatar fosfatizzato fosforanowany фосфатирование </p>	<p>03839</p>	<p>Volvo</p>
 <p> Güte/Quality/qualité/calidad/qualità/ Jakość/Качество 10.9 Oberfläche/Surface/surface/siperficie/ superfici/Powierzchnia/поверхность phosphatiert phosphated phosphaté fosfatar fosfatizzato fosforanowany фосфатирование </p>	<p>01230</p>	<p>Volvo</p>

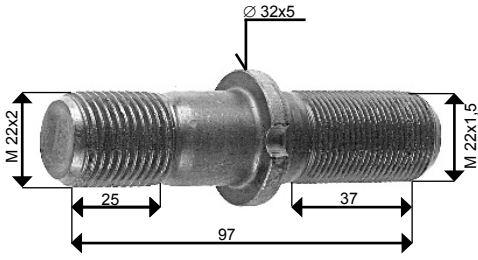
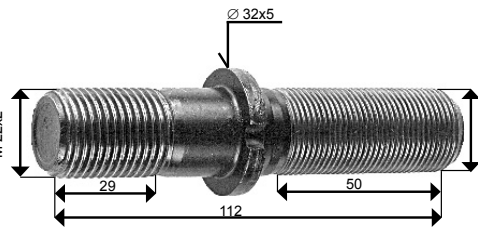
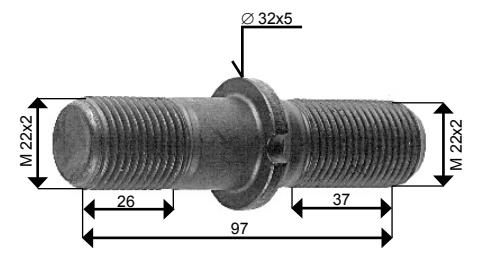
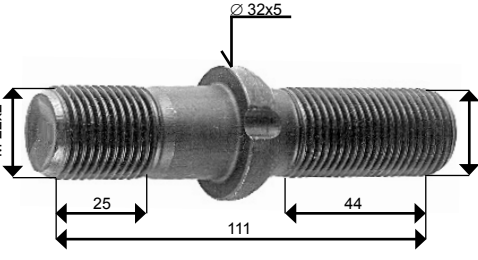

 		passend für: to fit: adapté à: apropiado para: adattabile per: pasuje dla: подходящий для:
 <p>Güte/Quality/qualité/calidad/qualità/ Jakość/Качество 10.9</p> <p>Oberfläche/Surface/surface/siperficie/ superfici/Powierzchnia/поверхность phosphatiert phosphated phosphaté fosfatar fosfatzizzato fosforanowany фосфатирование</p>	01457	Mercedes-Benz
 <p>Güte/Quality/qualité/calidad/qualità/ Jakość/Качество 10.9</p> <p>Oberfläche/Surface/surface/siperficie/ superfici/Powierzchnia/поверхность phosphatiert phosphated phosphaté fosfatar fosfatzizzato fosforanowany фосфатирование</p>	01273	Bergische Achsen
 <p>Güte/Quality/qualité/calidad/qualità/ Jakość/Качество 10.9</p> <p>Oberfläche/Surface/surface/siperficie/ superfici/Powierzchnia/поверхность phosphatiert phosphated phosphaté fosfatar fosfatzizzato fosforanowany фосфатирование</p>	05746	SAF
 <p>Güte/Quality/qualité/calidad/qualità/ Jakość/Качество 10.9</p> <p>Oberfläche/Surface/surface/siperficie/ superfici/Powierzchnia/поверхность phosphatiert phosphated phosphaté fosfatar fosfatzizzato fosforanowany фосфатирование</p>	05751	SAF

 		passend für: to fit: adapté à: apropiado para: adattabile per: pasuje dla: подходящий для:
 <p>Güte/Quality/qualité/calidad/qualità/ Jakość/Качество 10.9</p> <p>Oberfläche/Surface/surface/siperficie/ superfici/Powierzchnia/поверхность phosphatiert phosphated phosphaté fosfatar fosfatizzato fosforanowany фосфатирование</p>	05208	Bergische Achsen Kässbohrer
 <p>Güte/Quality/qualité/calidad/qualità/ Jakość/Качество 10.9</p> <p>Oberfläche/Surface/surface/siperficie/ superfici/Powierzchnia/поверхность phosphatiert phosphated phosphaté fosfatar fosfatizzato fosforanowany фосфатирование</p>	05210	Bergische Achsen Kässbohrer
 <p>Güte/Quality/qualité/calidad/qualità/ Jakość/Качество 10.9</p> <p>Oberfläche/Surface/surface/siperficie/ superfici/Powierzchnia/поверхность phosphatiert phosphated phosphaté fosfatar fosfatizzato fosforanowany фосфатирование</p>	01275	Bergische Achsen Sauer Achsen
 <p>Güte/Quality/qualité/calidad/qualità/ Jakość/Качество 10.9</p> <p>Oberfläche/Surface/surface/siperficie/ superfici/Powierzchnia/поверхность phosphatiert phosphated phosphaté fosfatar fosfatizzato fosforanowany фосфатирование</p>	01277	Bergische Achsen Kässbohrer SAF

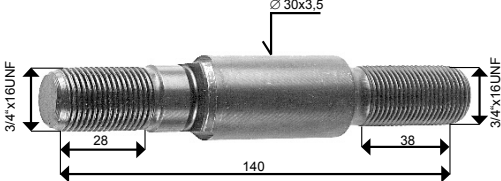
 		<p>passend für: to fit: adapté à: apropiado para: adattabile per: pasuje dla: подходящий для:</p>
 <p>Güte/Quality/qualité/calidad/qualità/ Jakość/Качество 10.9</p> <p>Oberfläche/Surface/surface/siperficie/ superfici/Powierzchnia/поверхность dacromet</p>	<p>03609</p>	<p>Volvo</p>

Radmutter mit Druckteller · wheel nut with pressure plate ·
 Ecrou de roue avec rondelle de pression ·
 Tuerca de rueda con platillo de presión · Dado con rondella ·
 Nakrętką koła z talerzem naciskowym · колесная гайка с упорным диском

Truck
Division

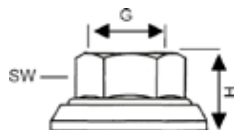

	G	H	SW	Güte quality Qualité Calidad Qualità Jakość Качество	Oberfläche surface Surface Siperficie Superfici Powierzchnia поверхность		passend für: to fit: adapté à: apropiado para: adattabile per: pasuje dla: подходящий для:
	M14 x 1,5	19	21	10	phosphatiert phosphated phosphaté fosfatar fosfatizzato fosforanowany фосфатирование	23756	universell verwendbar universal application universellement utilisable universalmente aplicable applicazione universale stosowany uniwersalnie универсальное применение
	M18 x 1,5	24,25	27	10	dacromet 500	26828	MAN Mercedes-Benz RENAULT TRUCKS universell verwendbar universal application universellement utilisable universalmente aplicable applicazione universale stosowany uniwersalnie универсальное применение
	M18 x 1,5	25	27	10	phosphatiert phosphated phosphaté fosfatar fosfatizzato fosforanowany фосфатирование	04899	Bergische Achsen IVECO MAN Volkswagen Volvo universell verwendbar universal application universellement utilisable universalmente aplicable applicazione universale stosowany uniwersalnie универсальное применение
	M18 x 1,5	25	27	10	geomet	45019	IVECO universell verwendbar universal application universellement utilisable universalmente aplicable applicazione universale stosowany uniwersalnie универсальное применение

Die Teilenummern der Automobilwerke dürfen nicht bei Berechnung an Fahrzeugbesitzer verwendet werden.
 Die von uns gelieferten Produkte sind ausschließlich dem bestimmungsgemäßen Gebrauch zuzuführen
 Der Einbau darf nur durch geschultes Fachpersonal erfolgen.

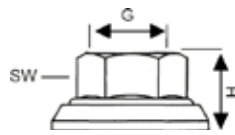

	G	H	SW	Güte quality Qualité Calidad Qualità Jakość Качество	Oberfläche surface Surface Siperficie Superfici Powierzchnia поверхность		passend für: to fit: adapté à: apropiado para: adattabile per: pasuje dla: подходящий для:
	M20 x 1,5	25,5	30	10	dacromet 500	45149	MAN Mercedes-Benz
	M22 x 1,5	26	32	10	phosphatiert phosphated phosphaté fosfatar fosfatzato fosforanowany фосфатирование	04029	Bergische Achsen DAF EvoBus IVECO Kässbohrer Achsen MAN Mercedes-Benz ROR SAF Volvo universell verwendbar universal application universellement utilisable universalmente aplicable applicazione universale stosowany uniwersalnie универсальное применение
	M22 x 1,5	26	33	10	dacromet 500	34334	Irisbus IVECO universell verwendbar universal application universellement utilisable universalmente aplicable applicazione universale stosowany uniwersalnie универсальное применение

Radmutter mit Druckteller · wheel nut with pressure plate ·
 Ecrou de roue avec rondelle de pression ·
 Tuerca de rueda con platillo de presión · Dado con rondella ·
 Nakrętką koła z talerzem naciskowym · колесная гайка с упорным диском

Truck
Division

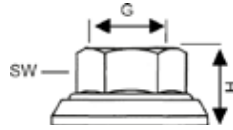

	G	H	SW	Güte quality Qualité Calidad Qualità Jakość Качество	Oberfläche surface Surface Siferficie Superfici Powierzchnia поверхность		passend für: to fit: adapté à: apropiado para: adattabile per: pasuje dla: подходящий для:
	M22 x 1,5	27	32	10	dacromet	07663	Bergische Achsen EvoBus IVECO MAN Mercedes-Benz SAF universell verwendbar universal application universellement utilisable universalmente aplicable applicazione universale stosowany uniwersalnie универсальное применение
	M22 x 1,5	30	33	10	dacromet	24241	RENAULT TRUCKS universell verwendbar universal application universellement utilisable universalmente aplicable applicazione universale stosowany uniwersalnie универсальное применение
	M22 x 1,5	30	33	10	phosphatiert phosphated phosphaté fosfatar fosfatizzato fosforanowany фосфатирование	24626	RENAULT TRUCKS Volvo universell verwendbar universal application universellement utilisable universalmente aplicable applicazione universale stosowany uniwersalnie универсальное применение

Die Teilenummern der Automobilwerke dürfen nicht bei Berechnung an Fahrzeugbesitzer verwendet werden.
 Die von uns gelieferten Produkte sind ausschließlich dem bestimmungsgemäßen Gebrauch zuzuführen
 Der Einbau darf nur durch geschultes Fachpersonal erfolgen.

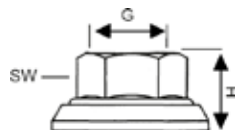

	G	H	SW	Güte quality Qualité Calidad Qualità Jakość Качество	Oberfläche surface Surface Siperficie Superfici Powierzchnia поверхность		passend für: to fit: adapté à: apropiado para: adattabile per: pasuje dla: подходящий для:
	M22 x 1,5	30	33	10	geomet	03794	Fruehauf RENAULT TRUCKS SAF Trailor universell verwendbar universal application universellement utilisable universalmente aplicable applicazione universale stosowany uniwersalnie универсальное применение
	M22 x 1,5	30	33	10	phosphatiert phosphated phosphaté fosfatar fosfatzizzato fosforanowany фосфатирование	15144	DAF
	M22 x 1,5	31	32	10	phosphatiert phosphated phosphaté fosfatar fosfatzizzato fosforanowany фосфатирование	05211	Bergische Achsen DAF Kässbohrer ROR universell verwendbar universal application universellement utilisable universalmente aplicable applicazione universale stosowany uniwersalnie универсальное применение
	M22 x 1,5	31	32	10	dacromet	22777	Bergische Achsen SAF

Radmutter mit Druckteller · wheel nut with pressure plate ·
 Ecrou de roue avec rondelle de pression ·
 Tuerca de rueda con platillo de presión · Dado con rondella ·
 Nakrętką koła z talerzem naciskowym · колесная гайка с упорным диском

Truck
Division

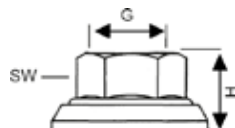



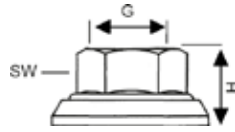

	G	H	SW	Güte quality Qualité Calidad Qualità Jakość Качество	Oberfläche surface Surface Siperficie Superfici Powierzchnia поверхность		passend für: to fit: adapté à: apropiado para: adattabile per: pasuje dla: подходящий для:
	M22 x 1,5	49	33	10	phosphatiert phosphated phosphaté fosfatar fosfatizzato fosforanowany фосфатирование	07301	Bergische Achsen SAF universell verwendbar universal application universellement utilisable universalmente aplicable applicazione universale stosowany uniwersalnie универсальное применение mit Deckel/with cover/ avec couvercle/con tapa/ con coperchio/z pokrywą/ с крышкой
	3/4" - 16 UNF	34	30	10	phosphatiert phosphated phosphaté fosfatar fosfatizzato fosforanowany фосфатирование	02796	Volvo universell verwendbar universal application universellement utilisable universalmente aplicable applicazione universale stosowany uniwersalnie универсальное применение
	7/8" - 14 UNF	30/36	33	10	phosphatiert phosphated phosphaté fosfatar fosfatizzato fosforanowany фосфатирование	12414	Volvo universell verwendbar universal application universellement utilisable universalmente aplicable applicazione universale stosowany uniwersalnie универсальное применение

Die Teilenummern der Automobilwerke dürfen nicht bei Berechnung an Fahrzeugbesitzer verwendet werden.
 Die von uns gelieferten Produkte sind ausschließlich dem bestimmungsgemäßen Gebrauch zuzuführen
 Der Einbau darf nur durch geschultes Fachpersonal erfolgen.

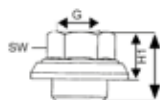



	G	H	SW	Güte quality Qualité Calidad Qualità Jakość Качество	Oberfläche surface Surface Siperficie Superfici Powierzchnia поверхность		passend für: to fit: adapté à: apropiado para: adattabile per: pasuje dla: подходящий для:
	7/8" - 11BSF	27	33	8	phosphatiert phosphated phosphaté fosfatar fosfatizzato fosforanowany фосфатирование	05160	Scania LHT universell verwendbar universal application universellement utilisable universalmente aplicable applicazione universale stosowany uniwersalnie универсальное применение
	7/8" - 11BSF	30	33	10	phosphatiert phosphated phosphaté fosfatar fosfatizzato fosforanowany фосфатирование	14959	Scania universell verwendbar universal application universellement utilisable universalmente aplicable applicazione universale stosowany uniwersalnie универсальное применение
	7/8" - 14UNF	34	33	10	phosphatiert phosphated phosphaté fosfatar fosfatizzato fosforanowany фосфатирование	04778	Volvo universell verwendbar universal application universellement utilisable universalmente aplicable applicazione universale stosowany uniwersalnie универсальное применение

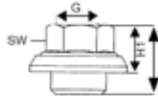

	G	H H1/H2	SW	Güte quality Qualité Calidad Qualità Jakość Качество	Oberfläche surface Surface Siperficie Superfici Powierzchnia поверхность		passend für: to fit: adapté à: apropiado para: adattabile per: pasuje dla: подходящий для:
	M12 x 1,5	27,5	19	8	verzinkt galvanized galvanisé galvanizado zincato ocynkowany оцинкованный	07176	universell verwendbar universal application universellement utilisable universalmente aplicable applicazione universale stosowany uniwersalnie универсальное применение
	M12 x 1,5	31	19	10	verchromt chromed chromé cromado cromato chromowany хромированный	29463	universell verwendbar universal application universellement utilisable universalmente aplicable applicazione universale stosowany uniwersalnie универсальное применение
	M22 x 1,5	27/39	32	10	phosphatiert phosphated phosphaté fosfatar fosfatzato fosforanowany фосфатирование	03799	Bergische Achsen MAN DAF Alcoa Felgen Alcoa rims Alcoa Jantes Alcoa Llantas Alcoa Cerchioni Alcoa Oprawa Alcoa Ободы universell verwendbar universal application universellement utilisable universalmente aplicable applicazione universale stosowany uniwersalnie универсальное применение



	G	H H1/H2	SW	Güte quality Qualité Calidad Qualità Jakość Качество	Oberfläche surface Surface Siperficie Superfici Powierzchnia поверхность		passend für: to fit: adapté à: apropiado para: adattabile per: pasuje dla: подходящий для:
	M22 x 1,5	27/39	32	10	phosphatiert phosphated phosphaté fosfatar fosfatizzato fosforanowany фосфатирование	07967	universell verwendbar universal application universellement utilisable universalmente aplicable applicazione universale stosowany uniwersalnie универсальное применение Speedline-Felge-/Rim/Jante/ Llanta/cerchione/Oprawa/ Ободы mit Deckel/with cover/ avec couvercle/con tapa/ con coperchio/z pokrywą/ с крышкой
	M22 x 1,5	27/62	32	10	phosphatiert phosphated phosphaté fosfatar fosfatizzato fosforanowany фосфатирование	04689	Bergische Achsen DAF EvoBus MAN Mercedes-Benz Alcoa Felgen Alcoa rims Alcoa Jante Alcoa Llanta Alcoa Cerchioni Alcoa Oprawa Alcoa Ободы universell verwendbar universal application universellement utilisable universalmente aplicable applicazione universale stosowany uniwersalnie универсальное применение
	M22 x 1,5	27/62	32	10	phosphatiert phosphated phosphaté fosfatar fosfatizzato fosforanowany фосфатирование	07974	Iveco universell verwendbar universal application universellement utilisable universalmente aplicable applicazione universale stosowany uniwersalnie универсальное применение Speedline-Felge-/Rim/Jante/ Llanta/cerchione/ Oprawa/ Ободы mit Deckel/with cover/ avec couvercle/con tapa/ con coperchio/z pokrywą/ с крышкой

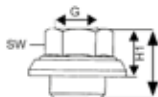

	G	H H1/H2	SW	Güte quality Qualité Calidad Qualità Jakość Качество	Oberfläche surface Surface Siperficie Superfici Powierzchnia поверхность		passend für: to fit: adapté à: apropiado para: adattabile per: pasuje dla: подходящий для:
	M22 x 1,5	35	33	10	phosphatiert phosphated phosphaté fosfatar fosfatzato fosforanowany фосфатирование	24335	Volvo universell verwendbar universal application universellement utilisable universalmente aplicable applicazione universale stosowany uniwersalnie универсальное применение
	M22 x 1,5	39	32	10	dacromet	28097	EvoBus IVECO Mercedes-Benz universell verwendbar universal application universellement utilisable universalmente aplicable applicazione universale stosowany uniwersalnie универсальное применение
	M22 x 1,5	62	32	10	dacromet 500	46788	MAN Neoplan

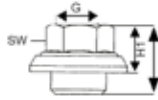



	G	H H1/H2	SW	Güte quality Qualité Calidad Qualità Jakość Качество	Oberfläche surface Surface Siperficie Superfici Powierzchnia поверхность		passend für: to fit: adapté à: apropiado para: adattabile per: pasuje dla: подходящий для:
	7/8" - 11BSF	38/50	33	10	phosphatiert phosphated phosphaté fosfatar fosfatizzato fosforanowany фосфатирование	03565	IVECO universell verwendbar universal application universellement utilisable universalmente aplicable applicazione universale stosowany uniwersalnie универсальное применение Speedline-Felge/-Rim/Jante/ Llanta/cerchione/ Oprawa/ Ободы mit Deckel/with cover/ avec couvercle/con tapa/ con copercchio/z pokrywą/ с крышкой
	7/8" - 11BSF	38/78,5	33	10	phosphatiert phosphated phosphaté fosfatar fosfatizzato fosforanowany фосфатирование	03569	universell verwendbar universal application universellement utilisable universalmente aplicable applicazione universale stosowany uniwersalnie универсальное применение
	7/8" - 14UNF	38/50	33	10	phosphatiert phosphated phosphaté fosfatar fosfatizzato fosforanowany фосфатирование	03566	Volvo Alcoa Felgen Alcoa rims Alcoa Jantes Alcoa Llantas Alcoa Cerchioni Alcoa Oprawa Alcoa Ободы universell verwendbar universal application universellement utilisable universalmente aplicable applicazione universale stosowany uniwersalnie универсальное применение mit Deckel/with cover/ avec couvercle/con tapa/ con copercchio/z pokrywą/ с крышкой

Radmutter mit Druckteller für Alu-Räder · Wheel nut with pressure plate for alu-rims · Ecrou de roue avec rondelle de pression pour alu-roes · Tuerca de rueda con platillo de presión para alu-ruedas · Dado con rondella per alu-ruote · Nakrętką koła z talerzem naciskowym na koła · колесная гайка с упорным диском для Колеса

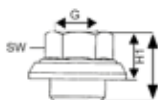
Truck
Division 



	G	H H1/H2	SW	Güte quality Qualité Calidad Qualità Jakość Качество	Oberfläche surface Surface Siperficie Superfici Powierzchnia поверхность		passend für: to fit: adapté à: apropiado para: adattabile per: pasuje dla: подходящий для:
	7/8" - 14UNF	38/78,5	33	10	phosphatiert phosphated phosphaté fosfatar fosfatizzato fosforanowany фосфатирование	03570	Volvo Alcoa Felgen Alcoa rims Alcoa Jantes Alcoa Llantas Alcoa Cerchioni Alcoa Oprawa Alcoa Ободы universell verwendbar universal application universellement utilisable universalmente aplicable applicazione universale stosowany uniwersalnie универсальное применение mit Deckel/with cover/ avec couvercle/con tapa/ con copercchio/z pokrywą/ с крышкой

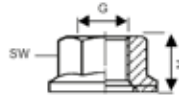

	G	H	SW	Güte quality Qualité Calidad Qualità Jakość Качество	Oberfläche surface Surface Siperficie Superfici Powierzchnia поверхность		passend für: to fit: adapté à: apropiado para: adattabile per: pasuje dla: подходящий для:
	M12 x 1,5	13	17	10	phosphatiert phosphated phosphaté fosfatar fosfatizzato fosforanowany фосфатирование	03555	MAN universell verwendbar universal application universellement utilisable universalmente aplicable applicazione universale stosowany uniwersalnie универсальное применение
	M14 x 1,5	15	19	8	phosphatiert phosphated phosphaté fosfatar fosfatizzato fosforanowany фосфатирование	01221	Bergische Achsen MAN Mercedes-Benz universell verwendbar universal application universellement utilisable universalmente aplicable applicazione universale stosowany uniwersalnie универсальное применение
	M14 x 1,5	16	19	10	phosphatiert phosphated phosphaté fosfatar fosfatizzato fosforanowany фосфатирование	03556	Mercedes-Benz universell verwendbar universal application universellement utilisable universalmente aplicable applicazione universale stosowany uniwersalnie универсальное применение

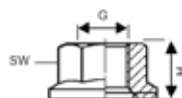

	G	H	SW	Güte quality Qualité Calidad Qualità Jakość Качество	Oberfläche surface Surface Siperficie Superfici Powierzchnia поверхность		passend für: to fit: adapté à: apropiado para: adattabile per: pasuje dla: подходящий для:
	M14 x 1,5	15	19	10	gelb verzinkt yellow galvanized galvanisé jaune amarillo galvanizado zincato giallo ocynkowany na żółto желтая оцинковка	07400	MAN universell verwendbar universal application universellement utilisable universalmente aplicable applicazione universale stosowany uniwersalnie универсальное применение
	M14 x 1,5	16	19	10	geomet	22474	Mercedes-Benz universell verwendbar universal application universellement utilisable universalmente aplicable applicazione universale stosowany uniwersalnie универсальное применение
	M16 x 1,5	17	22	10	phosphatiert phosphated phosphaté fosfatar fosfatzato fosforanowany фосфатирование	07428	MAN universell verwendbar universal application universellement utilisable universalmente aplicable applicazione universale stosowany uniwersalnie универсальное применение

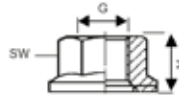

	G	H	SW	Güte quality Qualité Calidad Qualità Jakość Качество	Oberfläche surface Surface Siperficie Superfici Powierzchnia поверхность		passend für: to fit: adapté à: apropiado para: adattabile per: pasuje dla: подходящий для:
	M16 x 1,5	18	22	10	gelb verzinkt yellow galvanized galvanisé jaune amarillo galvanizado zincato giallo ocynkowany na żółto желтая оцинковка	03582	MAN universell verwendbar universal application universellement utilisable universalmente aplicable applicazione universale stosowany uniwersalnie универсальное применение
	M18 x 1,5	19	24	10	phosphatiert phosphated phosphaté fosfatar fosfatizzato fosforanowany фосфатирование	03966	Bergische Achsen Kässbohrer MAN Mercedes Benz Trailor universell verwendbar universal application universellement utilisable universalmente aplicable applicazione universale stosowany uniwersalnie универсальное применение
	M18 x 2	20	27	10,9	verzinkt galvanized galvanisé galvanizado zincato ocynkowany оцинкованный	03641	Bergische Achsen MAN Mercedes Benz Scania Trilex universell verwendbar universal application universellement utilisable universalmente aplicable applicazione universale stosowany uniwersalnie универсальное применение

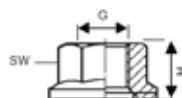

	G	H	SW	Güte quality Qualité Calidad Qualità Jakość Качество	Oberfläche surface Surface Siperficie Superfici Powierzchnia поверхность		passend für: to fit: adapté à: apropiado para: adattabile per: pasuje dla: подходящий для:
	M18 x 2	24	27	10	gelb verzinkt yellow galvanized galvanisé jaune amarillo galvanizado zincato giallo ocynkowany na żółto желтая оцинковка	02423	MAN
	M20 x 1,5	21	27	10	phosphatiert phosphated phosphaté fosfatar fosfizzato fosforanowany фосфатирование	03964	Bergische Achsen IVECO Kässbohrer Achsen MAN Mercedes-Benz universell verwendbar universal application universellement utilisable universalmente aplicable applicazione universale stosowany uniwersalnie универсальное применение
	M20 x 2	20	27	10,9	verzinkt galvanized galvanisé galvanizado zincato ocynkowany оцинкованный	03182	Bergisch Achsen DAF MAN Mercedes-Benz Scania Trilex Volvo universell verwendbar universal application universellement utilisable universalmente aplicable applicazione universale stosowany uniwersalnie универсальное применение

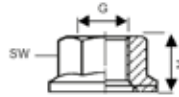



	G	H	SW	Güte quality Qualité Calidad Qualità Jakość Качество	Oberfläche surface Surface Siperficie Superfici Powierzchnia поверхность		passend für: to fit: adapté à: apropiado para: adattabile per: pasuje dla: подходящий для:
	M22 x 1,5	22	27	10	phosphatiert phosphated phosphaté fosfatar fosfatzizzato fosforanowany фосфатирование	03558	Bergische Achsen EvoBus IVECO Kässbohrer Achsen MAN Mercedes-Benz NEOPLAN universell verwendbar universal application universellement utilisable universalmente aplicable applicazione universale stosowany uniwersalnie универсальное применение
	M22 x 1,5	22	30	10	phosphatiert phosphated phosphaté fosfatar fosfatzizzato fosforanowany фосфатирование	04901	Bergische Achsen EvoBus IVECO MAN Mercedes-Benz universell verwendbar universal application universellement utilisable universalmente aplicable applicazione universale stosowany uniwersalnie универсальное применение
	M22 x 1,5	22	30	10	gelb verzinkt yellow galvanized galvanisé jaune amarillo galvaniz- ado zincato giallo ocynkowany na zółto желтая оцинковка	03767	MAN NEOPLAN universell verwendbar universal application universellement utilisable universalmente aplicable applicazione universale stosowany uniwersalnie универсальное применение

Flachbundmutter nach DIN 74361 · flat collar nut to DIN 74361 ·
 Ecrou DIN 74361 · Tuerca plana con collar DIN 74361 · Dado con battuta DIN 74361 ·
 Nakrętka wieńcowa płaska DIN 74361 · гайка с фланцем DIN 74361

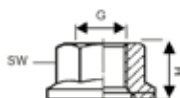
Truck
 Division 



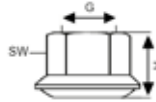

	G	H	SW	Güte quality Qualité Calidad Qualità Jakość Качество	Oberfläche surface Surface Siperficie Superfici Powierzchnia поверхность		passend für: to fit: adapté à: apropiado para: adattabile per: pasuje dla: подходящий для:
	M22 x 2	31	32	10	phosphatiert phosphated phosphaté fosfatar fosfatizzato fosforanowany фосфатирование	06254	Bergische Achsen universell verwendbar universal application universellement utilisable universalmente aplicable applicazione universale stosowany uniwersalnie универсальное применение



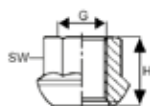



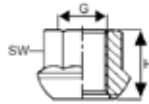

	G	H	SW	Güte quality Qualité Calidad Qualità Jakość Качество	Oberfläche surface Surface Siperficie Superfici Powierzchnia поверхность		passend für: to fit: adapté à: apropiado para: adattabile per: pasuje dla: подходящий для:
	M22 x 1,5	35	32	10	phosphatiert phosphated phosphaté fosfatar fosfatizzato fosforanowany фосфатирование	08048	Bergische Achsen Trailer universell verwendbar universal application universellement utilisable universalmente aplicable applicazione universale stosowany uniwersalnie универсальное применение RHT
	M22 x 2	35	32	8	phosphatiert phosphated phosphaté fosfatar fosfatizzato fosforanowany фосфатирование	08047	Bergische Achsen universell verwendbar universal application universellement utilisable universalmente aplicable applicazione universale stosowany uniwersalnie универсальное применение RHT







	G	H	SW	Güte quality Qualité Calidad Qualità Jakość Качество	Oberfläche surface Surface Siperficie Superfici Powierzchnia поверхность		passend für: to fit: adapté à: apropiado para: adattabile per: pasuje dla: подходящий для:
	M12 x 1,5	18,5	17	8	verzinkt zinc-plated galvanisé galvanizado zincato осынокwany оцинкованный	03857	universell verwendbar universal application universellement utilisable universalmente aplicable applicazione universale stosowany uniwersalnie универсальное применение
	M14 x 1,5	20	19	8	phosphatiert phosphated phosphaté fosfatar fosfatizzato fosforanowany фосфатирование	01214	Mercedes-Benz universell verwendbar universal application universellement utilisable universalmente aplicable applicazione universale stosowany uniwersalnie универсальное применение
	M14 x 1,5	20	19	10	gelb verzinkt yellow zinc-plated galvanisé jaune amarillo galvanizado zincato giallo осынокwany na żółto желтая оцинковка	05246	universell verwendbar universal application universellement utilisable universalmente aplicable applicazione universale stosowany uniwersalnie универсальное применение
	M16 x 1,5	22,5	24	8	phosphatiert phosphated phosphaté fosfatar fosfatizzato fosforanowany фосфатирование	06218	universell verwendbar universal application universellement utilisable universalmente aplicable applicazione universale stosowany uniwersalnie универсальное применение

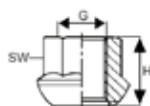

	G	H	SW	Güte quality Qualité Calidad Qualità Jakość Качество	Oberfläche surface Surface Siperficie Superfici Powierzchnia поверхность		passend für: to fit: adapté à: apropiado para: adattabile per: pasuje dla: подходящий для:
	M16 x 1,5	25	24	10	verzinkt galvanized galvanisé galvanizado zincato осынокwany оцинкованный	06566	universell verwendbar universal application universellement utilisable universalmente aplicable applicazione universale stosowany uniwersalnie универсальное применение
	M16 x 1,5	25	24	10	phosphatiert phosphated phosphaté fosfatar fosfatizzato fosforanowany фосфатирование	03774	universell verwendbar universal application universellement utilisable universalmente aplicable applicazione universale stosowany uniwersalnie универсальное применение
	M18 x 1,5	25	24	10	phosphatiert phosphated phosphaté fosfatar fosfatizzato fosforanowany фосфатирование	04235	Bergische Achsen universell verwendbar universal application universellement utilisable universalmente aplicable applicazione universale stosowany uniwersalnie универсальное применение
	M18 x 1,5	25	24	10	verzinkt galvanized galvanisé galvanizado zincato осынокwany оцинкованный	05247	universell verwendbar universal application universellement utilisable universalmente aplicable applicazione universale stosowany uniwersalnie универсальное применение





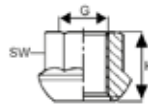

	G	H	SW	Güte quality Qualité Calidad Qualità Jakość Качество	Oberfläche surface Surface Siperficie Superfici Powierzchnia поверхность		passend für: to fit: adapté à: apropiado para: adattabile per: pasuje dla: подходящий для:
	M18 x 1,5	25	24	10	gelb verzinkt yellow zinc-plated galvanisé jaune amarillo galvanizado zincato giallo ocynkowany na żółto желтая оцинковка	03736	universell verwendbar universal application universellement utilisable universalmente aplicable applicazione universale stosowany uniwersalnie универсальное применение
	M20 x 1,5	27	27	10	phosphatiert phosphated phosphaté fosfatar fosfatizzato fosforowany фосфатирование	04227	Bergische Achsen universell verwendbar universal application universellement utilisable universalmente aplicable applicazione universale stosowany uniwersalnie универсальное применение
	M20 x 1,5	27	27	10	gelb verzinkt yellow zinc-plated galvanisé jaune amarillo galvanizado zincato giallo ocynkowany na żółto желтая оцинковка	03748	universell verwendbar universal application universellement utilisable universalmente aplicable applicazione universale stosowany uniwersalnie универсальное применение
	M22 x 1,5	30	27	10	phosphatiert phosphated phosphaté fosfatar fosfatizzato fosforowany фосфатирование	04237	Bergische Achsen universell verwendbar universal application universellement utilisable universalmente aplicable applicazione universale stosowany uniwersalnie универсальное применение

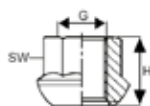

	G	H	SW	Güte quality Qualité Calidad Qualità Jakość Качество	Oberfläche surface Surface Siperficie Superfici Powierzchnia поверхность		passend für: to fit: adapté à: apropiado para: adattabile per: pasuje dla: подходящий для:
	M22 x 1,5	30	27	10	gelb verzinkt yellow zinc-plated galvanisé jaune amarillo galvanizado zincato giallo osynkowany na żółto желтая оцинковка	03791	universell verwendbar universal application universellement utilisable universalmente aplicable applicazione universale stosowany uniwersalnie универсальное применение
	M22 x 1,5	30	30	10	phosphatiert phosphated phosphaté fosfatar fosfatizzato fosforanowany фосфатирование	03869	universell verwendbar universal application universellement utilisable universalmente aplicable applicazione universale stosowany uniwersalnie универсальное применение
	M22 x 1,5	30	30	10	gelb verzinkt yellow zinc-plated galvanisé jaune amarillo galvanizado zincato giallo osynkowany na żółto желтая оцинковка	03749	universell verwendbar universal application universellement utilisable universalmente aplicable applicazione universale stosowany uniwersalnie универсальное применение
	M12 x 1,5	18	17	10	phosphatiert phosphated phosphaté fosfatar fosfatizzato fosforanowany фосфатирование	03722	universell verwendbar universal application universellement utilisable universalmente aplicable applicazione universale stosowany uniwersalnie универсальное применение



	G	H	SW	Güte quality Qualité Calidad Qualità Jakość Качество	Oberfläche surface Surface Siperficie Superfici Powierzchnia поверхность		passend für: to fit: adapté à: apropiado para: adattabile per: pasuje dla: подходящий для:
	M12 x 1,5	20	19	10	phosphatiert phosphated phosphaté fosfatar fosfatizzato fosforanowany фосфатирование	03870	universell verwendbar universal application universellement utilisable universalmente aplicable applicazione universale stosowany uniwersalnie универсальное применение
	M14 x 1,5	20	19	10	gelb verzinkt yellow zinc- plated galvanisé jaune amarillo galvaniz- ado zincato giallo осынкowany na żółto желтая оцинковка	03730	universell verwendbar universal application universellement utilisable universalmente aplicable applicazione universale stosowany uniwersalnie универсальное применение

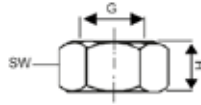

G	H	SW	Güte quality Qualité Calidad Qualità Jakość Качество	DIN	Oberfläche surface Surface Siperficie Superfici Powierzchnia поверхность		passend für: to fit: adapté à: apropiado para: adattabile per: pasuje dla: подходящий для:
M14 x 1,5	11	22	8,8	934	gelbverzinkt yellow galvanized galvanisé jaune amarillo galvanizado zincato giallo осынокwany na żółto желтая оцинковка	01010	DAF IVECO MAN universell verwendbar universal application universellement utilisable universalmente aplicable applicazione universale stosowany uniwersalnie универсальное применение
M14 x 1,5	13,7	22	8,8	985	gelbverzinkt yellow galvanized galvanisé jaune amarillo galvanizado zincato giallo осынокwany na żółto желтая оцинковка	22600	universell verwendbar universal application universellement utilisable universalmente aplicable applicazione universale stosowany uniwersalnie универсальное применение
M14 x 2	10,7	22	8,8	934	gelbverzinkt yellow galvanized galvanisé jaune amarillo galvanizado zincato giallo осынокwany na żółto желтая оцинковка	22791	universell verwendbar universal application universellement utilisable universalmente aplicable applicazione universale stosowany uniwersalnie универсальное применение
M18 x 2	15	27	8,8	934	blank pièce brute pieza bruta pezzo greggio Półfabrykat заготовка	02489	MAN universell verwendbar universal application universellement utilisable universalmente aplicable applicazione universale stosowany uniwersalnie универсальное применение

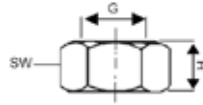

G	H	SW	Güte quality Qualité Calidad Qualità Jakość Качество	DIN	Oberfläche surface Surface Siperficie Superfici Powierzchnia поверхность		passend für: to fit: adapté à: apropiado para: adattabile per: pasuje dla: подходящий для:
M20 x 1,5	15	30	10	934	phosphatiert phosphated phosphaté fosfatar fosfatizzato fosforanowany фосфатирование gekörnt/center punched/ranulé/ granulado/con buli natura	05391	Bergische Achsen Kässbohrer SAF universell verwendbar universal application universellement utilisable universalmente aplicable applicazione universale stosowany uniwersalnie универсальное применение
M20 x 1,5	16	30	8,8	934	gelbverzinkt yellow galvanized galvanisé jaune amarillo galvanizado zincato giallo осынокwany na żółto желтая оцинковка	01561	DAF EvoBus MAN Mercedes-Benz Neoplan universell verwendbar universal application universellement utilisable universalmente aplicable applicazione universale stosowany uniwersalnie универсальное применение
M20 x 2,5	16	30	8	934	gelbverzinkt yellow galvanized galvanisé jaune amarillo galvanizado zincato giallo осынокwany na żółto желтая оцинковка	12283	DAF
M20 x 2,5	15,3	30	8,8	934	verzinkt galvanized galvanisé galvanizado zincato осынокwany оцинкованный	22790	universell verwendbar universal application universellement utilisable universalmente aplicable applicazione universale stosowany uniwersalnie универсальное применение

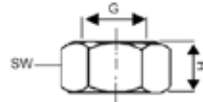

G	H	SW	Güte quality Qualité Calidad Qualità Jakość Качество	DIN	Oberfläche surface Surface Siperficie Superfici Powierzchnia поверхность		passend für: to fit: adapté à: apropiado para: adattabile per: pasuje dla: подходящий для:
M22 x 1,5	16	32	10	934	phosphatiert phosphated phosphaté fosfatar fosfatizzato fosforanowany фосфатирование gekörnt/center punched/ranulé/ granulado/con buli natura	06425	Bergische Achsen SAF universell verwendbar universal application universellement utilisable universalmente aplicable applicazione universale stosowany uniwersalnie универсальное применение
M22 x 1,5	25	32	10	934	phosphatiert phosphated phosphaté fosfatar fosfatizzato fosforanowany фосфатирование	04938	Bergische Achsen ROR SAF universell verwendbar universal application universellement utilisable universalmente aplicable applicazione universale stosowany uniwersalnie универсальное применение
M22 x 2,0	17	32	10	936	phosphatiert phosphated phosphaté fosfatar fosfatizzato fosforanowany фосфатирование	01279	Bergische Achsen Kässbohrer SAF universell verwendbar universal application universellement utilisable universalmente aplicable applicazione universale stosowany uniwersalnie универсальное применение
M22 x 1,5	25	32	10	936	phosphatiert phosphated phosphaté fosfatar fosfatizzato fosforanowany фосфатирование	01280	Bergische Achsen DAF SAF universell verwendbar universal application universellement utilisable universalmente aplicable applicazione universale stosowany uniwersalnie универсальное применение

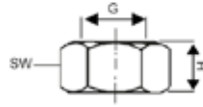

G	H	SW	Güte quality Qualité Calidad Qualità Jakość Качество	DIN	Oberfläche surface Surface Siperficie Superfici Powierzchnia поверхность		passend für: to fit: adapté à: apropiado para: adattabile per: pasuje dla: подходящий для:
M22 x 2	30	32	10	936	phosphatiert phosphated phosphaté fosfatar fosfatizzato fosforanowany фосфатирование	03205	Bergische Achsen Kässbohrer universell verwendbar universal application universellement utilisable universalmente aplicable applicazione universale stosowany uniwersalnie универсальное применение
M22 x 2	48	33	10	936	phosphatiert phosphated phosphaté fosfatar fosfatizzato fosforanowany фосфатирование	05717	Bergische Achsen universell verwendbar universal application universellement utilisable universalmente aplicable applicazione universale stosowany uniwersalnie универсальное применение
M24 x 2	19	36	8	934	phosphatiert phosphated phosphaté fosfatar fosfatizzato fosforanowany фосфатирование	08178	Bergische Achsen MAN SAF universell verwendbar universal application universellement utilisable universalmente aplicable applicazione universale stosowany uniwersalnie универсальное применение

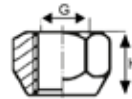

G	H	SW	Güte quality Qualité Calidad Qualità Jakość Качество	Oberfläche surface Surface Siperficie Superfici Powierzchnia поверхность		passend für: to fit: adapté à: apropiado para: adattabile per: pasuje dla: подходящий для:	Bemerkung comments Remarques Comentarios Nota Uwaga Примеч.
7/8" - 11BSF	16	33	10	phosphatiert phosphated phosphaté fosfatar fosfatizzato fosforanowany фосфатирование	03851	Scania	RHT universell verwendbar universal application universellement utilisable universalmente aplicable applicazione universale stosowany uniwersalnie универсальное применение
7/8" - 11BSF	27	33	8	phosphatiert phosphated phosphaté fosfatar fosfatizzato fosforanowany фосфатирование	03848	ROR Scania SAF	LHT universell verwendbar universal application universellement utilisable universalmente aplicable applicazione universale stosowany uniwersalnie универсальное применение



Ø innen/inner/ intérieur/interior/inter- no/wewnętrzny/ внутри	Ø außen/outer/ extérieur/exterior/ esterno/na zewnątrz/ внешни	H		passend für: to fit: adapté à: apropiado para: adattabile per: pasuje dla: подходящий для:	Bemerkung comments Remarques Comentarios Nota Uwaga Примеч.
14,1	24	3	01472	Mercedes-Benz universell verwendbar universal application universellement utilisable universalmente aplicable applicazione universale stosowany uniwersalnie универсальное применение	DIN 74361
18,2	26	3	01656	IVECO Mercedes-Benz universell verwendbar universal application universellement utilisable universalmente aplicable applicazione universale stosowany uniwersalnie универсальное применение	DIN 74361
20,2	32	6	01345	Bergische Achsen IVECO Mercedes-Benz universell verwendbar universal application universellement utilisable universalmente aplicable applicazione universale stosowany uniwersalnie универсальное применение	DIN 74361
22,2	32	5,5	01346	DAF EvoBus IVECO MAN Mercedes-Benz universell verwendbar universal application universellement utilisable universalmente aplicable applicazione universale stosowany uniwersalnie универсальное применение	DIN 74361 geschlitzt slit fendu ranurado con fressura rozcięty шлицован.

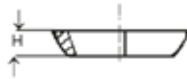

\varnothing innen/inner/ intérieur/interior/inter- no/wewnętrz/ внутри	\varnothing außen/outer/ extérieur/exterior/ esterno/na zewnątrz/ внешни	H		passend für: to fit: adapté à: apropiado para: adattabile per: pasuje dla: подходящий для:	Bemerkung comments Remarques Comentarios Nota Uwaga Примеч.
24,6	38	12	05901	Bergische Achsen NEOPLAN universell verwendbar universal application universellement utilisable universalmente aplicable applicazione universale stosowany uniwersalnie универсальное применение	DIN 74361 geschlitzt slit fendu ranurado con fressura rozcięty шлицован.







Ø innen/inner/ intérieur/interior/ interno/wewnętrzny/ внутри	Ø außen/outer/ extérieur/exterior/ na zewnątrz/ внешний	H	DIN		passend für: to fit: adapté à: apropiado para: adattabile per: pasuje dla: подходящий для:
14,5	23	5	74361	01241	Bergische Achsen Mercedes-Benz universell verwendbar universal application universellement utilisable universalmente aplicable applicazione universale stosowany uniwersalnie универсальное применение
16,5	27	7,5	74361	01242	universell verwendbar universal application universellement utilisable universalmente aplicable applicazione universale stosowany uniwersalnie универсальное применение
18,5	29	7	74361	01243	Bergische Achsen IVECO Mercedes-Benz universell verwendbar universal application universellement utilisable universalmente aplicable applicazione universale stosowany uniwersalnie универсальное применение
20,5	34	8	74361	01244	Bergische Achsen EvoBus IVECO Kässbohrer MAN Mercedes-Benz Neoplan SAF universell verwendbar universal application universellement utilisable universalmente aplicable applicazione universale stosowany uniwersalnie универсальное применение







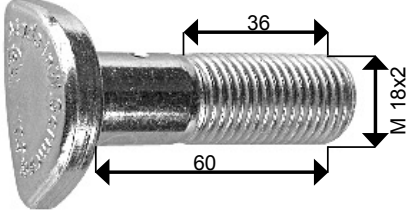
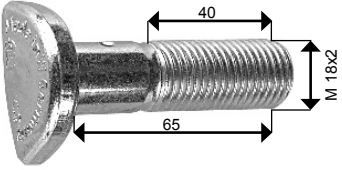
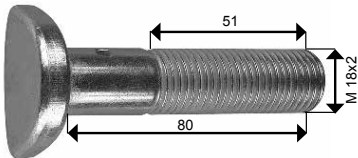
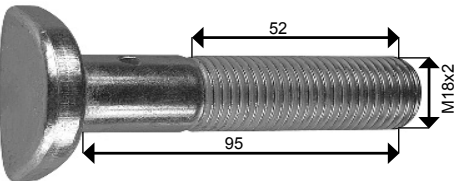

\varnothing innen/inner/ intérieur/interior/ interno/wewnątrz/ внутри	\varnothing außen/outer/ extérieur/ exterior/esterno/ na zewnątrz/ внешний	H	DIN		passend für: to fit: adapté à: apropiado para: adattabile per: pasuje dla: подходящий для:
22,5	34	8	74361	01245	Bergische Achsen DAF EvoBus IVECO Kässbohrer MAN Mercedes-Benz Neoplan ROR SAF universell verwendbar universal application universellement utilisable universalmente aplicable applicazione universale stosowany uniwersalnie универсальное применение
22,5	34,5	9,5	74361	05719	Bergische Achsen universell verwendbar universal application universellement utilisable universalmente aplicable applicazione universale stosowany uniwersalnie универсальное применение



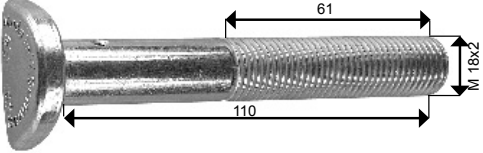
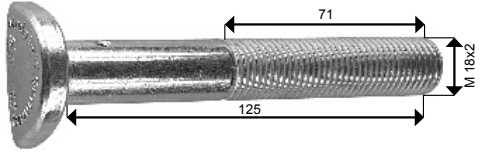
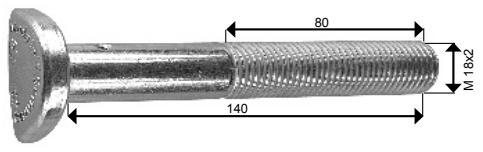



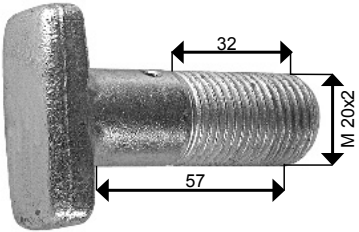
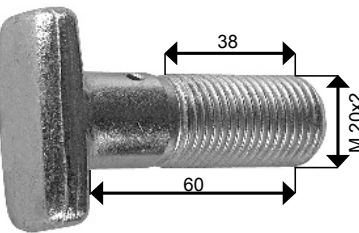
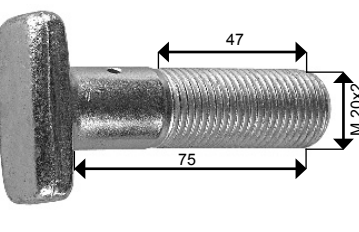
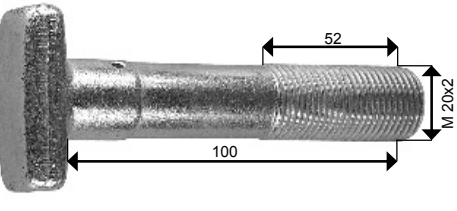

Ø innen/inner/ intérieur/interior/ interno/wewnętrzny/ внутри	Ø außen/outer/ extérieur/exte- rior/esterno/na zewnątrz/внешний	H		passend für: to fit: adapté à: apropiado para: adattabile per: pasuje dla: подходящий для:	Bemerkung comments Remarques Comentarios Nota Uwaga Примеч.
22	25	18	07635	Bergische Achsen	
22	25	6	07636	Bergische Achsen Kässbohrer Achsen	

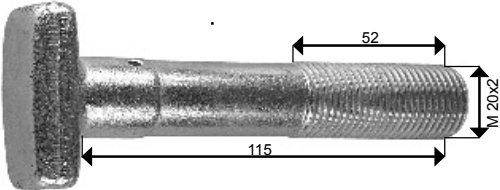
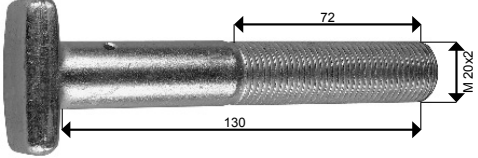

 		<p>passend für: to fit: adapté à: apropiado para: adattabile per: pasuje dla: подходящий для:</p>
 <p>Güte/Quality/qualité/calidad/qualità/Jakość/ Качество 10,9</p> <p>Oberfläche/Surface/surface/siperficie/superfici/ Powierzchnia/поверхность gelb verzinkt yellow galvanized galvanisé jaune amarillo galvanizado zincato giallo осынокваны на зółто желтая оцинковка</p>	<p>01983</p>	<p>Bergische Achsen MAN Mercedes Benz Scania Trilex universell verwendbar universal application universellement utilisable universalmente aplicable applicazione universale stosowany uniwersalnie универсальное применение</p>
 <p>Güte/Quality/qualité/calidad/qualità/Jakość/ Качество 10,9</p> <p>Oberfläche/Surface/surface/siperficie/superfici/ Powierzchnia/поверхность verzinkt galvanized galvanisé galvanizado zincato осынокваны оцинкованный</p>	<p>05684</p>	<p>MAN Mercedes Benz Trilex universell verwendbar universal application universellement utilisable universalmente aplicable applicazione universale stosowany uniwersalnie универсальное применение</p>
 <p>Güte/Quality/qualité/calidad/qualità/Jakość/ Качество 10,9</p> <p>Oberfläche/Surface/surface/siperficie/superfici/ Powierzchnia/поверхность verzinkt galvanized galvanisé galvanizado zincato осынокваны оцинкованный</p>	<p>05687</p>	<p>MAN Mercedes Benz Trilex universell verwendbar universal application universellement utilisable universalmente aplicable applicazione universale stosowany uniwersalnie универсальное применение</p>
 <p>Güte/Quality/qualité/calidad/qualità/Jakość/ Качество 10,9</p> <p>Oberfläche/Surface/surface/siperficie/superfici/ Powierzchnia/поверхность gelb verzinkt yellow galvanized galvanisé jaune amarillo galvanizado zincato giallo осынокваны на зółто желтая оцинковка</p>	<p>01984</p>	<p>Bergische Achsen MAN Mercedes Benz Trilex universell verwendbar universal application universellement utilisable universalmente aplicable applicazione universale stosowany uniwersalnie универсальное применение</p>



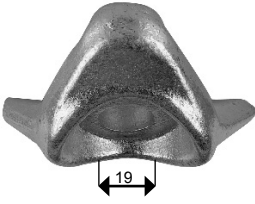
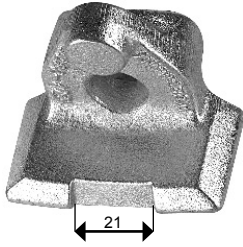
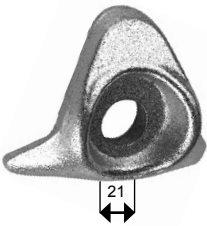

 		passend für: to fit: adapté à: apropiado para: adattabile per: pasuje dla: подходящий для:
 <p>Güte/Quality/qualité/calidad/qualità/Jakość/ Качество 10,9</p> <p>Oberfläche/Surface/surface/siperficie/superfici/ Powierzchnia/ поверхность gelb verzinkt yellow galvanized galvanisé jaune amarillo galvanizado zincato giallo осыпкowany на жółто желтая оцинковка</p>	<p>01985</p>	Bergische Achsen MAN Mercedes Benz Scania Trilex universell verwendbar universal application universellement utilisable universalmente aplicable applicazione universale stosowany uniwersalnie универсальное применение
 <p>Güte/Quality/qualité/calidad/qualità/Jakość/ Качество 10,9</p> <p>Oberfläche/Surface/surface/siperficie/superfici/ Powierzchnia/ поверхность gelb verzinkt yellow galvanized galvanisé jaune amarillo galvanizado zincato giallo осыпкowany на жółто желтая оцинковка</p>	<p>03554</p>	Bergische Achsen MAN Mercedes Benz Trilex universell verwendbar universal application universellement utilisable universalmente aplicable applicazione universale stosowany uniwersalnie универсальное применение
 <p>Güte/Quality/qualité/calidad/qualità/Jakość/ Качество 10,9</p> <p>Oberfläche/Surface/surface/siperficie/superfici/ Powierzchnia/ поверхность gelb verzinkt yellow galvanized galvanisé jaune amarillo galvanizado zincato giallo осыпкowany на жółто желтая оцинковка</p>	<p>01986</p>	Bergische Achsen MAN Mercedes Benz Trilex universell verwendbar universal application universellement utilisable universalmente aplicable applicazione universale stosowany uniwersalnie универсальное применение



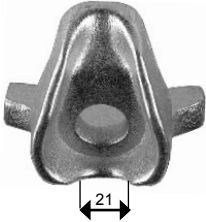
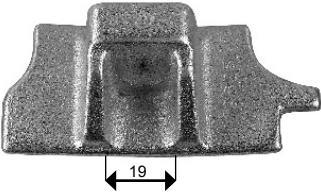
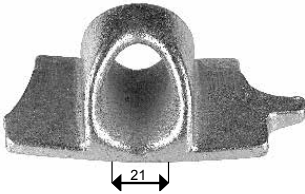

 		<p>passend für: to fit: adapté à: apropiado para: adattabile per: pasuje dla: подходящий для:</p>
 <p>Güte/Quality/qualité/calidad/qualità/ Jakość/Kачество 10,9</p> <p>Oberfläche/Surface/surface/siperficie/ superfici/Powierzchnia/поверхность verzinkt galvanized galvanisé galvanizado zincato осункованы оцинкованный</p>	<p>08547</p>	<p>Bergische Achsen Mercedes Benz Scania Trilex Volvo universell verwendbar universal application universellement utilisable universalmente aplicable applicazione universale stosowany uniwersalnie универсальное применение</p>
 <p>Güte/Quality/qualité/calidad/qualità/ Jakość/Kачество 10,9</p> <p>Oberfläche/Surface/surface/siperficie/ superfici/Powierzchnia/поверхность verzinkt galvanized galvanisé galvanizado zincato осункованы оцинкованный</p>	<p>03177</p>	<p>Bergische Achsen Mercedes Benz Scania Trilex Volvo universell verwendbar universal application universellement utilisable universalmente aplicable applicazione universale stosowany uniwersalnie универсальное применение</p>
 <p>Güte/Quality/qualité/calidad/qualità/ Jakość/Kачество 10,9</p> <p>Oberfläche/Surface/surface/siperficie/ superfici/Powierzchnia/поверхность verzinkt galvanized galvanisé galvanizado zincato осункованы оцинкованный</p>	<p>05691</p>	<p>MAN Mercedes Benz Trilex Volvo universell verwendbar universal application universellement utilisable universalmente aplicable applicazione universale stosowany uniwersalnie универсальное применение</p>
 <p>Güte/Quality/qualité/calidad/qualità/ Jakość/Kачество 10,9</p> <p>Oberfläche/Surface/surface/siperficie/ superfici/Powierzchnia/поверхность verzinkt galvanized galvanisé galvanizado zincato осункованы оцинкованный</p>	<p>14963</p>	<p>Bergische Achsen DAF Scania Trilex universell verwendbar universal application universellement utilisable universalmente aplicable applicazione universale stosowany uniwersalnie универсальное применение</p>





 		passend für: to fit: adapté à: apropiado para: adattabile per: pasuje dla: подходящий для:
 <p>Güte/Quality/qualité/calidad/qualità/ Jakość/Качество 10,9</p> <p>Oberfläche/Surface/surface/siperficie/ superfici/Powierzchnia/поверхность verzinkt galvanized galvanisé galvanizado zincato осцинкованы оцинкованный</p>	05693	Bergische Achsen MAN Mercedes Benz Scania Trilex Volvo universell verwendbar universal application universellement utilisable universalmente aplicable applicazione universale stosowany uniwersalnie универсальное применение
 <p>Güte/Quality/qualité/calidad/qualità/ Jakość/Качество 10,9</p> <p>Oberfläche/Surface/surface/siperficie/ superfici/Powierzchnia/поверхность verzinkt galvanized galvanisé galvanizado zincato осцинкованы оцинкованный</p>	05694	Bergische Achsen Trilex universell verwendbar universal application universellement utilisable universalmente aplicable applicazione universale stosowany uniwersalnie универсальное применение
 <p>Güte/Quality/qualité/calidad/qualità/ Jakość/Качество 10,9</p> <p>Oberfläche/Surface/surface/siperficie/ superfici/Powierzchnia/поверхность verzinkt galvanized galvanisé galvanizado zincato осцинкованы оцинкованный</p>	24774	Trilex universell verwendbar universal application universellement utilisable universalmente aplicable applicazione universale stosowany uniwersalnie универсальное применение





 		passend für: to fit: adapté à: apropiado para: adattabile per: pasuje dla: подходящий для:
 <p>Güte/Quality/qualité/calidad/qualità/ Jakość/Kачество 10,9</p> <p>Oberfläche/Surface/surface/ siperficie/superfici/Powierzchnia/ поверхность verzinkt galvanized galvanisé galvanizado zincato осункваны оцинкованный</p>	01210	Trilex Vorderräder Front Wheels Roues avant Ruedas delanteras Ruote anteriori kolo przednie переднее колесо universell verwendbar universal application universellement utilisable universalmente aplicable applicazione universale stosowany uniwersalnie универсальное применение
 <p>Güte/Quality/qualité/calidad/qualità/ Jakość/Kачество 10,9</p> <p>Oberfläche/Surface/surface/ siperficie/superfici/Powierzchnia/ поверхность verzinkt galvanized galvanisé galvanizado zincato осункваны оцинкованный</p>	03804	Trilex Vorderräder Front Wheels Roues avant Ruedas delanteras Ruote anteriori kolo przednie переднее колесо universell verwendbar universal application universellement utilisable universalmente aplicable applicazione universale stosowany uniwersalnie универсальное применение
 <p>Güte/Quality/qualité/calidad/qualità/ Jakość/Kачество 10,9</p> <p>Oberfläche/Surface/surface/ siperficie/superfici/Powierzchnia/ поверхность verzinkt galvanized galvanisé galvanizado zincato осункваны оцинкованный</p>	05680	Trilex Vorderräder Front Wheels Roues avant Ruedas delanteras Ruote anteriori kolo przednie переднее колесо universell verwendbar universal application universellement utilisable universalmente aplicable applicazione universale stosowany uniwersalnie универсальное применение





 		passend für: to fit: adapté à: apropiado para: adattabile per: pasuje dla: подходящий для:
 <p>Güte/Quality/qualité/calidad/qualità/ Jakość/Качество 10,9</p> <p>Oberfläche/Surface/surface/ siperficie/superfici/Powierzchnia/ поверхность verzinkt galvanized galvanisé galvanizado zincato осункованы оцинкованный</p>	04916	Trilex Vorderräder Front Wheels Roues avant Ruedas delanteras Ruote anteriori koło przednie переднее колесо universell verwendbar universal application universellement utilisable universalmente aplicable applicazione universale stosowany uniwersalnie универсальное применение
 <p>Güte/Quality/qualité/calidad/qualità/ Jakość/Качество 10,9</p> <p>Oberfläche/Surface/surface/ siperficie/superfici/Powierzchnia/ поверхность verzinkt galvanized galvanisé galvanizado zincato осункованы оцинкованный</p>	02825	Trilex Hinterräder Rear Wheels Roues arrière Ruedas traseras Ruote posteriori tylne koło заднее колесо universell verwendbar universal application universellement utilisable universalmente aplicable applicazione universale stosowany uniwersalnie универсальное применение
 <p>Güte/Quality/qualité/calidad/qualità/ Jakość/Качество 10,9</p> <p>Oberfläche/Surface/surface/ siperficie/superfici/Powierzchnia/ поверхность verzinkt galvanized galvanisé galvanizado zincato осункованы оцинкованный</p>	05681	Trilex universell verwendbar universal application universellement utilisable universalmente aplicable applicazione universale stosowany uniwersalnie универсальное применение





Radbolzen wheel stud Goujon de roue Gorrón de rueda Colonna ruota Śruba koła шпилька колесная		Komplettierungsteile completion parts Pièces de complément Piezas complementarias Parti di completamento Kompletowanie Комплекующие				Fahrzeugtyp vehicle type type de véhicule tipo de vehículo tipo veicolo Typ wózka марку автомобиля	Radbolzen kpl. Wheel stud cpl. Goujon de roue clp. Gorrón de rueda clp. Colonna ruota clp. Śruba koła clp. шпилька колесная clp.
vorne front avant delantero delantero z przodu спереди	hinten rear arrière trasero posteriore tył сзади					LKW/trucks/Camion Camión/Vehicoli industriali Busse/busses/Bus autobuses/autobus Achsen/axles/Essieux/Ejes/ Assi	
	01230	04778				Volvo	
	01429	03964		01244	01345	EvoBus	06278
	01429	03964		01244	01345	Mercedes-Benz	06278
01429		03964		01244	01345	Mercedes-Benz	06278
	01471	03556		01241	01472	EvoBus	06271
	01471	03556		01241	01472	Mercedes-Benz	06271
01473		03964		01244		EvoBus	06275
01473		03964		01244		Mercedes-Benz	06275
	01474	03964		01244	01345	EvoBus	06280
	01474	03964		01244	01345	Mercedes-Benz	06280
01647		03966		01243		Mercedes-Benz	
	01647	03966		01243	01656	EvoBus	06274
	01647	03966		01243	01656	Mercedes-Benz	06274
01648		03558		01245		EvoBus	06281
01648		03558		01245		Mercedes-Benz	06281
01648		04901		01245		EvoBus	07937
01648		04901		01245		Mercedes-Benz	07937
	01648	03558		01245	01346	Mercedes-Benz	
01654		03966		01243		EvoBus	06272
01654		03966		01243		Mercedes-Benz	06272
	01654	03966		01243	01656	EvoBus	06273
	01654	03966		01243	01656	Mercedes-Benz	06273
02406	02406	04938		01245		SAF	01834
02406	02406	04029		01832		SAF	01833
02406	02406	07663				SAF	
02406	02406	04029				SAF	06465
02407	02407	04938		01245		SAF	
02504	02504	04938		01245		ROR	02505
	02666	03964		01244	01345	EvoBus	06279
	02666	03964		01244	01345	Mercedes-Benz	06279
	03125	03964		01244	01345	EvoBus	06277
	03125	03964		01244	01345	Mercedes-Benz	06277
03176		03556		01241		Mercedes-Benz	06270
03176	03176	03556				Volkswagen	

Radbolzen wheel stud Goujon de roue Gorrón de rueda Colonna ruota Śruba koła шпилька колесная		Komplettierungsteile completion parts Pièces de complément Piezas complementarias Parti di completamento Kompletowanie Комплекующие				Fahrzeugtyp vehicle type type de véhicule tipo de vehículo tipo veicolo Typ wózka марку автомобиля	Radbolzen kpl. Wheel stud cpl. Goujon de roue cpl. Gorrón de rueda cpl. Colonna ruota cpl. Śruba koła cpl. шпилька колесная cpl.
vorne front avant delantero delantero z przodu спереди	hinten rear arrière trasero posteriore tył сзади					LKW/trucks/Camion Camión/Vehicoli industriali Busse/busses/Bus autobuses/autobus Achsen/axles/Essieux/Ejes/ Assi	
	03552	03558		01245	01346	EvoBus	06292
	03552	03558		01245	01346	Mercedes-Benz	06292
	03552	04901		01245	01346	EvoBus	07947
	03552	04901		01245	01346	Mercedes-Benz	07947
	03552	04029				EvoBus	07948
	03552	04029				Mercedes-Benz	07948
	03552	03558		01245	01346	Mercedes-Benz	06292
	03552	04029				Mercedes-Benz	07948
	03552	04029				Mercedes-Benz	07948
	03552	04901		01245	01346	Mercedes-Benz	07947
	03552	03558		01245	01346	MAN	06292
	03552	04901		01245	01346	EvoBus	07947
	03552	04901		01245	01346	MAN	07947
	03552	04901		01245	01346	Mercedes-Benz	07947
	03552	04029				MAN	07948
	03740	03558		01245	01346	EvoBus	06293
	03740	03558		01245	01346	MAN	06293
	03740	03558		01245	01346	Mercedes-Benz	06293
	03740	04901		01245	01346	EvoBus	07949
	03740	04901		01245	01346	MAN	07949
	03740	04901		01245	01346	Mercedes-Benz	07949
	03740	04029				EvoBus	07950
	03740	04029				MAN	07950
	03740	04029				Mercedes-Benz	07950
	03740	03558		01245	01346	MAN	06293
	03740	04901		01245	01346	MAN	07949
	03740	04029				MAN	07950
03842		03848				Scania	
03842		05160				Scania	
03843		03851				Scania	
03843		14959				Scania	
	03844	03848				Scania	
	03845	03851				Scania	
	03958	03558		01245	01346	EvoBus	06289





Radbolzen wheel stud Goujon de roue Gorrón de rueda Colonna ruota Śruba koła шпилька колесная		Komplettierungsteile completion parts Pièces de complément Piezas complementarias Parti di completamento Kompletowanie Комплектующие				Fahrzeugtyp vehicle type type de véhicule tipo de vehículo tipo veicolo Typ wózka марку автомобиля	Radbolzen kpl. Wheel stud cpl. Goujon de roue clp. Gorrón de rueda clp. Colonna ruota clp. Śruba koła clp. шпилька колесная clp.
vorne front avant delantero delantero z przodu спереди	hinten rear arrière trasero posteriore tył сзади					LKW/trucks/Camion Camión/Vehicoli industriali Busse/busses/Bus autobuses/autobus Achsen/axles/Essieux/Ejes/ Assi	
	03958	03558		01245	01346	MAN	06289
	03958	03558		01245	01346	Mercedes Benz	06289
	03958	04029				MAN	07943
	03958	03558		01245	01346	EvoBus	06289
	03958	03558		01245	01346	Mercedes-Benz	06289
	03958	04029				Mercedes-Benz	07943
	03958	04901		01245	01346	Mercedes-Benz	07942
03960		03558		01245		Mercedes-Benz	06291
03960		04901		01245		Mercedes-Benz	07945
03960	03960	04029				Mercedes-Benz	07946
	03960	03558		01245		Mercedes-Benz	06291
03960		03558		01245		Mercedes-Benz	06291
03960		04901		01245		Mercedes-Benz	07945
03960		04029				EvoBus	07946
03960	03960	04029				MAN	07946
03960		04029				Mercedes-Benz	07946
03960		03558		01245		EvoBus	06291
03960		03558		01245		MAN	06291
03960		03558		01245		Mercedes-Benz	06291
03960		04901		01245		Evobus	07945
03960		04901		01245		MAN	07945
03960		04901		01245		Mercedes-Benz	07945
03960		04029				MAN	07946
	03960	04029				MAN	07946
	03960	03558		01245	01346	MAN	
	03960	04901		01245	01346	MAN	
	03961	03558		01245	01346	EvoBus	06294
	03961	03558		01245	01346	Mercedes-Benz	06294
	03961	04901		01245	01346	EvoBus	07951
	03961	04901		01245	01346	Mercedes-Benz	07951
	03961	04029				Mercedes-Benz	
03961	03961					MAN	
	03962	03558		01245	01346	MAN	
	03962	04029				MAN	

Radbolzen wheel stud Goujon de roue Gorrón de rueda Colonna ruota Śruba koła шпилька колесная		Komplettierungsteile completion parts Pièces de complément Piezas complementarias Parti di completamento Kompletowanie Комплекующие				Fahrzeugtyp vehicle type type de véhicule tipo de vehículo tipo veicolo Typ wózka марку автомобиля	Radbolzen kpl. Wheel stud cpl. Goujon de roue clp. Gorrón de rueda clp. Colonna ruota clp. Śruba koła clp. шпилька колесная clp.
vorne front avant delantero delantero z przodu спереди	hinten rear arrière trasero posteriore tył сзади					LKW/trucks/Camion Camión/Vehicoli industriali Busse/busses/Bus autobuses/autobus Achsen/axles/Essieux/Ejes/ Assi	
03997		03558		01245		EvoBus	06287
03997		04901		01245		MAN	07938
03997		04901		01245		Mercedes-Benz	07938
03997		04901		01245		MAN	07938
03997		04029				EvoBus	07939
03997	03997	04029				MAN	07939
03997		04029				Mercedes-Benz	07939
	03997	04029				EvoBus	07939
	03997	04029				MAN	07939
	03997	04029				Mercedes-Benz	07939
	03997	03558		01245		MAN	06287
	03997	04901		01245		EvoBus	07938
	03997	04901		01245		MAN	07938
	03997	04901		01245		Mercedes-Benz	07938
03997		03558		01245		EvoBus	06287
03997		03558		01245		MAN	06287
03997		03558		01245		Mercedes-Benz	06287
03997		04901		01245		EvoBus	07938
03997		04901		01245		MAN	07938
03997		04901		01245		Mercedes-Benz	07938
03997		04029				EvoBus	07939
03997		04029				MAN	07939
03997		04029				EvoBus	07939
	03997	04029				MAN	07939
03997	03997	04029				Mercedes-Benz	07939
04487		04029				Volvo	
	04574	04899				MAN	
05210		04938	01279	01245	05901	Bergische Achsen	03981
05524	05524	07663				Mercedes-Benz	27544
05524	05524	07663				EvoBus	27544
	05530	07663				Mercedes-Benz	27545
	05530	07663				EvoBus	27545
05778	05778	04778				Volvo	
05779	05779	04778				Volvo	

Radbolzen wheel stud Goujon de roue Gorrón de rueda Colonna ruota Śruba koła шпилька колесная		Komplettierungsteile completion parts Pièces de complément Piezas complementarias Parti di completamento Kompletowanie Комплекующие				Fahrzeugtyp vehicle type type de véhicule tipo de vehículo tipo veicolo Typ wózka марку автомобиля	Radbolzen kpl. Wheel stud cpl. Goujon de roue clp. Gorrón de rueda clp. Colonna ruota clp. Śruba koła clp. шпилька колесная clp.
vorne front avant delantero delantero z przodu спереди	hinten rear arrière trasero posteriore tył сзади					LKW/trucks/Camion Camión/Vehicoli industriali Busse/busses/Bus autobuses/autobus Achsen/axles/Essieux/Ejes/ Assi	
	05917	14959				Scania	
07304	07304	03794				Fruehauf	
07304	07304	03794				Trailor	
07312	07312	03794				Fruehauf	
07312	07312	03794				Trailor	
	07944	03558		01245	01346	Mercedes-Benz	
	07944	04901		01245	01346	Mercedes-Benz	
	07944	04029				Mercedes-Benz	
08442		05211				DAF	
08443		05211				DAF	
12862		03966		01243		Mercedes-Benz	
	12862	03966		01243	01656	Mercedes-Benz	
12863		03966		01243		Mercedes-Benz	
	12863	03966		01243	01656	Mercedes-Benz	
12865		03964		01244		Mercedes-Benz	
	12865	03964		01244	01345	Mercedes-Benz	
	12866	03964		01244	01345	Mercedes-Benz	
	12867	03964		01244	01345	Mercedes-Benz	
12868		03558		01245		Mercedes-Benz	
12868		04901		01245		Mercedes-Benz	
12868	12868	04029				Mercedes-Benz	
12868	12868	04901		01245		MAN	
12868	12868	04029				MAN	
12868	12868	03558		01245		MAN	
	12869	04029				Mercedes-Benz	
	12870	03558		01245	01346	Mercedes-Benz	
	12870	04901		01245	01346	Mercedes-Benz	
	12870	04029				Mercedes-Benz	
12871		03558		01245		Mercedes-Benz	
12871		04901		01245		Mercedes-Benz	
12871		04029				Mercedes-Benz	
	12871	04029				Mercedes-Benz	
	12871	03558		01245	01346	Mercedes-Benz	
12871		04901		01245		Neoplan	

Radbolzen wheel stud Goujon de roue Gorrón de rueda Colonna ruota Śruba koła шпилька колесная		Komplettierungsteile completion parts Pièces de complément Piezas complementarias Parti di completamento Kompletowanie Комплекующие				Fahrzeugtyp vehicle type type de véhicule tipo de vehículo tipo veicolo Typ wózka марку автомобиля	Radbolzen kpl. Wheel stud cpl. Goujon de roue clp. Gorrón de rueda clp. Colonna ruota clp. Śruba koła clp. шпилька колесная clp.
vorne front avant delantero delantero z przodu спереди	hinten rear arrière trasero posteriore tył сзади					LKW/trucks/Camion Camión/Vehicoli industriali Busse/busses/Bus autobuses/autobus Achsen/axles/Essieux/Ejes/ Assi	
12871	12871	04029				Neoplan	
	12871	03558		01245	01346	Neoplan	
12871		03558		01245		MAN	
12871		04901		01245		MAN	
12871	12871	04029				MAN	
	12871	03558		01245	01346	MAN	
	12872	03558		01245	01346	Mercedes-Benz	
	12872	04901		01245	01346	Mercedes-Benz	
	12872	04029				Mercedes-Benz	
	12872	04901		01245	01346	MAN	
	12872	04029				MAN	
	12873	04901		01245	01346	Mercedes-Benz	
	12873	04029				Mercedes-Benz	
	12873	04901		01245	01346	MAN	
	12873	04029				MAN	
	12874	04901		01245	01346	Mercedes-Benz	
	12874	04029				Mercedes-Benz	
14041						Evobus	
14041						MAN	
14853		14959				Scania	
15760	15760	04029				DAF	
	18825					Renault Trucks	
19331		04901				Evobus	
	32801	24626				Volvo	35176
29942	29942	07663				EvoBus	35502
29942	29942	07663				Mercedes-Benz	35502
	29943	07663				EvoBus	35503
	29943	07663				Mercedes-Benz	35503
35631		04901				IVECO	
40036		15144				DAF	
40510		14959				Scania	
	43538	07663				MAN	
43572		03966				DAF	
44311		24335				Renault Trucks	

Radbolzen wheel stud Goujon de roue Gorrón de rueda Colonna ruota Śruba koła шпилька колесная		Komplettierungsteile completion parts Pièces de complément Piezas complementarias Parti di completamento Kompletowanie Комплектующие				Fahrzeugtyp vehicle type type de véhicule tipo de vehículo tipo veicolo Typ wózka марку автомобиля	Radbolzen kpl. Wheel stud cpl. Goujon de roue cpl. Gorrón de rueda cpl. Colonna ruota cpl. Śruba koła cpl. шпилька колесная cpl.
vorne front avant delantero anteriore z przodu спереди	hinten rear arrière trasero posteriore tył сзади					LKW/trucks/Camion Camión/Vehicoli industriali Busse/busses/Bus autobuses/autobus Achsen/axles/Essieux/Ejes/ Assi	
44311		24335				Volvo	
44322	44322	07663				EvoBus	
44322	44322	07663				MAN	
44322	44322	07663				Mercedes-Benz	
45381		28097				IVECO	
45382		28097				IVECO	
45383		28097				IVECO	
45384		28097				IVECO	
45385		28097				IVECO	
45386		04900				IVECO	
45387		15144				IVECO	
	46135	24626				IVECO	
48667						IVECO	
48706		07663				Mercedes-Benz	
48707		07663				Mercedes-Benz	
48708		07663				Mercedes-Benz	
48709		07663				Mercedes-Benz	
48710		07663				Mercedes-Benz	

Radbolzen wheel stud Goujon de roue Gorron de rueda Colonna ruota Śruba koła шпилька колесная		Kompletierungsteile completion parts Pièces de complément Piezas complementarias Parti di completamento Kompletowanie Комплекующие				Fahrzeugtyp vehicle type type de véhicule tipo de vehículo tipo veicolo Тип вóзка марку автомобиля	Radbolzen kpl. Wheel stud cpl. Goujon de roue cpl. Gorron de rueda cpl. Colonna ruota cpl. Śruba koła cpl. шпилька колесная cpl.
vorne front avant delantero anteriore z przodu спереди	hinten rear arrière trasero posteriore tył сзади					LKW/trucks/Camion Camión/Vehicoli industriali Busse/busses/Bus autobúses/autobus Achsen/axles/Essieux/Ejes/ Assi	
01273	01273	03964	05391	01244		Bergische Achsen	01274
01275	01275	01280	01279	01245		Bergische Achsen	04233
01275	01275	03205	01279	01245		Bergische Achsen	01276
01275	01275	01280	01279	01245		SAF	04233
01277	01277	01280	01279	01245		SAF	01278
01277	01277	01280	01279	01245		Bergische Achsen	01278
01277	01277	03205	01279	01245		Bergische Achsen	03210
01277	01277	08047	01279			Bergische Achsen	02523
01277	01277	03205	01279	01245		Kässbohrer	03210
	01457	03558	01561	01245		EvoBus	06297
	01457	03558	01561	01245		Mercedes-Benz	06297
	01457	04901	01561	01245		EvoBus	07955
	01457	04901	01561	01245		Mercedes-Benz	07955
05208	05208	04938	01279	01245		Bergische Achsen	03980
05208	05208	05211	01279			Bergische Achsen	05207*
05208	05208	07301	01279			Bergische Achsen	07733*
05208	05208	05211	01279			Kässbohrer	05207*
05208	05208	07301	01279			Kässbohrer	07733*
	05210					DAF	
05210	05210		01279	01245		Kässbohrer	
05210	05210	04029	01279			Kässbohrer	07456*
05210	05210	05211	01279			Kässbohrer	05209*
05210	05210	04029	01279			Bergische Achsen	07456*
05210	05210	05211	01279			Bergische Achsen	05209*
05210	05210	07301	01279			Bergische Achsen	07300*
05210	05210	04029	01279			Bergische Achsen	08824
	05746					DAF	
05746	05746	04029	06425			SAF	05745
	05751					DAF	
05751	05751	04029	06425			SAF	05750

- * Hülse nicht in Radbolzen, kpl. enthalten
- * wheel bolt, cpl. without sleeve
- * Goujon de roue cpl. sans manchon
- * Gorron de rueda cpl. sin casquillo
- * Colonna ruota cpl. senza bussola
- * Sprawa nie jest w stadninach , kpl . zawierac
- * Дело не в Шпильки , CPL . содержать

Radbolzen wheel stud Goujon de roue Gorron de rueda Colonna ruota Šruba kola шпилька колесная	Komplettierungsteile completion parts Pièces de complément Piezas complementarias Parti di completamento Kompletowanie Комплекующие			Radbolzen kpl. Wheel stud cpl. Goujon de roue clp. Gorron de rueda clp. Colonna ruota clp. Šruba kola clp. шпилька колесная clp.
08547	03182		03517	08548
03177	03182		03517	03181
05691	03182		03517	05660
14963	03182		03517	15686
05693	03182	08310	03517	05678
05694	03182		03517	05661
01983	03641		03517	01205
05684	03641		03517	05672
05687	03641		03517	05659
01984	03641		03517	01206
01985	03641		03517	01207
03554	03641		03517	03527
01986	03641		03517	01839
24774	03182	08310	03517	24775

Passende Klemmplatten entnehmen Sie bitte der Seite 79, 80

Clamping Plates are illustrated on Page 79, 80

Plateau de serrage adapté page 79, 80

Placas de aprieto apropiado página 79, 80

Tasselli adattabile pagina 79, 80

Proszę Matching zaciski, patrz strona 79, 80

Пожалуйста Matching зажимы, стр 79, 80

Ref. - No.

Truck
Division 

Ref. - No.



Ref. - No.



passend für / to fit:

AUDI

WHT 001 693	21588	6
WHT 001 812	09801	3
WHT 002 437	09801	3
WHT 002 529	21588	6
3A0 601 139	06963	2
321 601 139 C	06963	2
431 601 139 A	09801	3
443 601 139 A	09801	3
443 601 139 C	09801	3
7L0 601 139 A	21588	6
8D0 601 139 A	09801	3
8D0 601 139 D	09801	3

passend für / to fit:

AUSSTATTUNG, ZUBEHÖR

KZE 0912-05	01241	72, 81
KZE 0912-06	03556	10, 53, 81

passend für / to fit:

BERGISCHE ACHSEN

02.1816.04.00	01210	79
02.1816.12.00	05680	79
02.1816.14.00	05681	80
02.1818.10.00	03517	89
02.5070.21.00	01985	76, 89
02.5070.21.00 kpl.	01207	89
02.5070.22.00	03554	76, 89
02.5070.22.00 kpl.	03527	89
02.5070.23.00	01986	76, 89
02.5070.23.00 kpl.	01839	89
02.5070.24.00	01983	75, 89
02.5070.24.00 kpl.	01205	89
02.5070.25.00	01984	75, 89
02.5070.25.00 kpl.	01206	89
02.5070.32.00	05693	78, 89
02.5070.32.00 kpl.	05678	89
02.5070.37.00	05693	78, 89
02.5070.37.00 kpl.	05678	89
02.5070.41.00	03554	76, 89
02.5070.41.00 kpl.	03527	89
02.5070.43.00	05694	78, 89
02.5070.43.00 kpl.	05661	89
02.5070.44.00	01985	76, 89

02.5070.44.00 kpl.	01207	89
02.5070.45.00	01986	76, 89
02.5070.45.00 kpl.	01839	89
02.5070.47.00	03177	77, 89
02.5070.47.00 kpl.	03181	89
02.5070.86.00	14963	77, 89
02.5070.86.00 kpl.	15686	89
02.5070.87.00	05694	78, 89
02.5070.87.00 kpl.	05661	89
02.5070.89.00	08547	77, 89
02.5070.89.00 kpl.	08548	89
02.5202.32.80	08178	68
02.5213.08.82	01221	53
02.5213.12.10	03966	55, 81, 85, 86
02.5213.14.10	03964	56, 81, 85, 88
02.5213.14.62	03964	56, 81, 85, 88
02.5213.16.10	03558	57, 81, 82, 83, 84, 85, 86, 88
02.5214.12.10	04235	61
02.5214.14.10	04227	62
02.5214.16.10	04237	62
02.5219.18.10	04899	11, 42, 84
02.5219.20.10	04900	87
02.5219.22.10	04029	43, 81, 82, 83, 84, 85, 86, 88
02.5219.23.10	05211	45, 85, 88
02.5219.33.10	03799	48
02.5219.34.10	04689	49
02.5270.02.00	03641	55, 89
02.5270.03.00	03641	55, 89
02.5270.04.00	03182	56, 89
02.5270.72.00	08047	59, 88
02.5270.73.00	06254	58
02.5270.77.10	08048	59
02.5450.22.00	08310	89
02.5615.14.90	01241	72, 81
02.5615.18.90	01243	72, 81, 85
02.5615.20.90	01244	72, 81, 85, 88
02.5615.22.90	01245	73, 81, 82, 83, 84, 85, 86, 88
03.112.00.42.0	07635	74
03.112.00.43.0	07636	74
03.143.00.02.0	05719	73



Ref. - No.		
03.260.03.05.0	05391	66, 88
03.260.04.01.0	01280	67, 88
03.260.04.02.0	03205	68, 88
03.260.04.06.0	01279	67, 84, 88
03.260.04.10.0	06425	67, 88
03.260.04.12.0	04938	67, 81, 84, 88
03.260.54.03.0	04901	57, 81, 82, 83, 84, 85, 86, 88
03.296.00.03.0	04781	12
03.296.12.04.0	01273	39, 88
03.296.12.07.0	01273	39, 88
03.296.13.09.0	01277	40, 88
03.296.23.05.0	01275	40, 88
03.296.23.15.0	05208	40, 88
03.296.23.17.0	05210	40, 84, 88
03.310.10.02.0	01345	70, 81, 85
03.310.10.13.0	05901	71, 84
05.260.14.05.0	05717	68
05.260.24.01.0	07301	46, 88
05.260.54.09.0	04029	43, 81, 82, 83, 84, 85, 86, 88
05.260.54.09.0	05211	45, 85, 88
05.260.54.10.0	07663	44, 81, 84, 86, 87
05.260.54.10.0	05211	45, 85, 88
05.260.54.10.0	22777	45
05.260.54.13.0	07301	46, 88
05.260.54.19.0	07301	46, 88
05.806.13.02.0	01278	88
05.806.13.14.0	03210	88
09.806.12.03.0	01274	88
09.806.13.02.0	01278	88
09.806.13.14.0	03210	88
09.806.13.30.0	02523	88
09.806.13.33.0	02523	88
09.806.23.02.0	04233	88
09.806.23.09.0	01276	88
09.806.23.18.0	05207	88
09.806.23.21.0	05209	88
09.80.623.2.20	07456	88
09.806.23.27.0	03980	88
09.806.23.28.0	03981	84
09.806.23.29.0	07300	88
09.806.23.37.0	07733	88

Ref. - No.		
09.80.623.4.10	07456	88
09.806.23.41.0	08824	88
passend für / to fit:		
CHRYSLER		
05103941AA	01472	70, 81
05104018AA	09806	6
05104080AA	24645	5
05104651AA	22474	9
05139905AA	03176	81
68006805AA	29466	4
passend für / to fit:		
CITROËN		
16 087 344 80	30400	1
5405.30	12706	3
5405.35	11616	1
5405.48	12707	4
5405.55	11616	1
5405.59	11616	1
5405.66	21175	1
5405.67	29208	1
5405.68	32439	4
5405.72	30400	1
5405.75	32440	3
5405.76	32450	6
5405.78	32441	5
5405.79	32442	7
5405.81	11939	8
5405.84	21175	1
5405.88	32441	5
passend für / to fit:		
DAF		
RAK 5904	15144	45, 86, 87
0099 717	08443	30, 85
0099 720	40036	20, 86
0099 730	08442	24, 85
0144 922	01280	67, 88
0251 279	12283	66
0260 261	01346	70, 81, 82, 83, 85, 86
0272 740	14963	77, 89
0272 740 S1	15686	89
0325 235	01245	73, 81, 82, 83, 84, 85, 86, 88

Ref. - No.

Truck
Division 

Ref. - No.



Ref. - No.



0506 666	03517	89
0620 646	08442	24, 85
0620 649	08443	30, 85
0620 652	04029	43, 81, 82, 83, 84, 85, 86, 88
0620 652	05211	45, 85, 88
0652 575	05211	45, 85, 88
0678 250	03182	56, 89
0890 763	15760	28, 86
1241 815	05211	45, 85, 88
1263 487	03799	48
1263 488	04689	49
1308 038	08443	30, 85
1309 190	15760	28, 86
1309 191	08442	24, 85
1337 020	40036	20, 86
1355 553	12283	66
1356 736	15760	28, 86
1356 737	05211	45, 85, 88
1358 990	05211	45, 85, 88
1400 082	43572	13, 86
1402 360	05211	45, 85, 88
1455 046	05211	45, 85, 88
1826 088	05211	45, 85, 88

passend für / to fit:

DODGE

05103938AA	01471	81
05104018AA	09806	6
05104080AA	24645	5
05104651AA	22474	9
05139905AA	03176	81
68006805AA	29466	4

passend für / to fit:

EVOBUS

000934 020008	01561	66, 88
074361 020352	01244	72, 81, 85, 88
074361 022203	03558	57, 81, 82, 83, 84, 85, 86, 88
074361 022205	04901	57, 81, 82, 83, 84, 85, 86, 88
074361 022351	01245	73, 81, 82, 83, 84, 85, 86, 88
3.384.015.071 S	06281	81

385 400 01 24	04029	43, 81, 82, 83, 84, 85, 86, 88
305 401 00 71	14041	21, 86
305 401 00 71	03997	23, 84
309 401 01 71	03176	12, 81
309 401 02 71 S1	06270	81
309 401 02 71	06270	81
309 401 02 71	03176	12, 81
314 401 00 71	01654	13, 81
317 401 03 71	03997	23, 84
317 401 04 71	03997	23, 84
318 401 00 71	01473	15, 81
319 401 06 71	03176	12, 81
319 401 09 71	03176	12, 81
324 401 00 71	12862	13, 85
327 401 02 71	03997	23, 84
327 401 04 71	03997	23, 84
338 401 50 71 S1	06281	81
338 401 50 71	06281	81
338 401 50 71 KPL/30	07937	81
338 401 50 71	01648	18, 81
338 401 50 71 S2	07937	81
346 401 00 71	12873	32, 86
346 401 00 71	03740	31, 82
346 401 00 71	06293	82
355 401 00 71	03552	30, 82
355 401 00 71	06292	82
356 401 00 71	14039	19
381 401 01 71	03997	23, 84
381 401 02 71	03997	23, 84
381 401 03 71	03958	26, 82, 83
381 401 03 71 S2	07942	83
381 401 03 71 S3	07943	83
381 401 03 71 KPL/30	07942	83
381 401 03 71 KPL/MZ	07943	83
381 401 03 71	06289	82, 83
381 401 03 71 S1	06289	82, 83
381 401 04 71	06291	83
381 401 04 71	03960	29, 83
381 401 05 71 S1	03960	29, 83
381 401 05 71 KPL/MZ	07946	83
381 401 05 71	06291	83
381 401 05 71 S5	07945	83



Ref. - No.		
381 401 05 71 KPL/30	07945	83
381 401 05 71 S3	06291	83
381 401 05 71 S4	07946	83
381 401 05 71	12871	29, 85, 86
381 401 06 71	03552	30, 82
381 401 06 71 S2	12872	30, 86
381 401 06 71 KPL/MZ	07948	82
381 401 06 71 S2	29942	30, 86
381 401 06 71 S1	03552	30, 82
381 401 06 71 S4	07948	82
381 401 06 71 S1	12872	30, 86
381 401 06 71 S5	07947	82
381 401 06 71	29942	30, 86
381 401 06 71 S1	29942	30, 86
381 401 06 71 KPL/30	07947	82
381 401 06 71	12872	30, 86
381 401 06 71 S6	35502	86
381 401 06 71 S2	03552	30, 82
381 401 06 71 S3	06292	82
381 401 06 71	06292	82
381 401 07 71 S1	12873	32, 86
381 401 07 71 S2	29943	32, 86
381 401 07 71 S1	03740	31, 82
381 401 07 71	29943	32, 86
381 401 07 71	06293	82
381 401 07 71 S2	12873	32, 86
381 401 07 71 S4	07950	82
381 401 07 71	12873	32, 86
381 401 07 71	03740	31, 82
381 401 07 71 KPL/MZ	07950	82
381 401 07 71 S6	35503	86
381 401 07 71 S3	06293	82
381 401 07 71 S5	07949	82
381 401 07 71 S2	03740	31, 82
381 401 07 71 KPL/30	07949	82
381 401 07 71 S1	29943	32, 86
381 401 08 71 S2	06294	83
381 401 08 71	12874	33, 86
381 401 08 71	06294	83
381 401 08 71 S3	07951	83
381 401 08 71 S1	03961	33, 83
381 401 08 71 KPL/30	07951	83
381 401 11 71	03960	29, 83

Ref. - No.		
381 401 11 71	06291	83
381 401 12 71 S1	07940	23
381 401 12 71 S2	12869	24, 85
389 401 00 71 S1	03997	23, 84
389 401 00 71	03997	23, 84
389 401 00 71	06287	84
389 401 00 71 S3	06287	84
389 401 00 71 S6	44322	22, 87
389 401 00 71 KPL/MZ	07939	84
389 401 00 71 S4	07938	84
389 401 00 71 KPL/30	07938	84
389 401 00 71 S2	12868	23, 85
389 401 00 71 S5	07939	84
389 401 01 71	12870	26, 85
389 401 01 71 S1	07944	26, 85
498 401 00 71	03960	29, 83
498 401 00 71	06291	83
942 401 02 71	05524	19, 84
942 401 02 71 S1	27544	84
942 401 03 71 S1	27545	84
942 401 03 71	05530	27, 84
948 401 00 71	29418	25
948 401 02 71	29418	25
000 401 06 72	07663	44, 81, 84, 86, 87
000 401 10 72 S1	04689	49
000 401 13 72	28097	50, 87
302 402 00 71	02666	16, 81
309 402 01 71	01471	12, 81
309 402 02 71	01471	12, 81
309 402 02 71 S1	06271	81
309 402 02 71	06271	81
312 402 10 71	03125	15, 81
314 402 00 71	12862	13, 85
314 402 00 71 S1	01654	13, 81
314 402 00 71 S3	06273	81
314 402 00 71	06273	81
314 402 00 71	06272	81
314 402 00 71 S2	06272	81
317 402 05 71	03958	26, 82, 83
318 402 00 71	06274	81
318 402 00 71 S1	01647	14, 81
318 402 00 71	12863	14, 85
318 402 00 71 S2	06274	81

Ref. - No.

Truck
Division 

Ref. - No.



Ref. - No.



319 402 01 71	01471	12, 81
319 402 03 71	01471	12, 81
319 402 04 71	01471	12, 81
324 402 00 71	01654	13, 81
327 402 02 71	06279	81
327 402 02 71	12866	16, 85
327 402 02 71 S2	06279	81
327 402 02 71 S1	02666	16, 81
327 402 03 71 S2	06280	81
327 402 03 71	12867	17, 85
327 402 03 71 S1	01474	17, 81
327 402 03 71 KOMPL.	06280	81
327 402 04 71	03958	26, 82, 83
352 402 00 71 S1	01429	15, 81
352 402 00 71	12865	16, 85
352 402 00 71	06278	81
352 402 00 71 S2	06278	81
352 402 01 71	03125	15, 81
352 402 01 71	06277	81
352 402 01 71 S1	06277	81
674 402 01 71	09298	14
317 402 01 75	01346	70, 81, 82, 83, 85, 86
6.125.312.233	19331	18, 86

passend für / to fit:

FIAT

13229724	12706	3
1345713080	32440	3
1345714080	32450	6
1351202080	32441	5
1351203080	32442	7
1363349080	32441	5
1476244080	12707	4
1493974080	32439	4
1608734480	30400	1
9634648980	30400	1
9644576680	29208	1
9682405480	21175	1

passend für / to fit:

FORD PKW

1 007 487	27413	7
1 126 877	17818	6
1 366 029	03427	8

1 371 365	39371	11
1 447 852	27413	7
1 462 130	36655	9
1 470 417	06218	11
1 470 843	27413	7
1 520 046	39371	11
1 576 434	39371	11
1 763 869	46049	10
4 052 603	39371	11
4 153 719	39371	11
4 367 098	36655	9
4 386 256	36655	9
4 451 436	36655	9
5 114 405	40247	7
5 114 407	44949	9
6 040 307	27413	7
6 106 730	03427	8
6 111 766	03427	8
6 119 808	06218	11
7 201 016	04912	5

passend für / to fit:

FRUEHAUF (CRANE)

A-JA-0491-001	07304	26, 85
A-JA-0491-002	07312	20, 85
A-JA-0495-001	03794	45, 85
A-JB-11623 A	07304	26, 85
M-003133	07312	20, 85
M-003141	03794	45, 85
M-006891	07304	26, 85

passend für / to fit:

IVECO

0 0112 1798	03964	56, 81, 85, 88
0 0112 1800	03558	57, 81, 82, 83, 84, 85, 86, 88
0 0112 1808	01243	72, 81, 85
0 0112 1810	01244	72, 81, 85, 88
0 0112 1811	01245	73, 81, 82, 83, 84, 85, 86, 88
0 0247 5869	35631	33, 86
0 0247 6077	05317	24
0 0247 6979	04900	87
0 0247 7764	04573	32
0 0247 8940	01656	70, 81, 85



Ref. - No.		
0 0341 4228	01345	70, 81, 85
0 0342 0371	01346	70, 81, 82, 83, 85, 86
0 0445 9602	04899	11, 42, 84
0 0445 9603	04029	43, 81, 82, 83, 84, 85, 86, 88
0 0445 9603 S1	07663	44, 81, 84, 86, 87
0 0716 8333	46135	14, 87
0 0716 8580	05317	24
0 0716 8838	45381	19, 87
0 4103 1725	04029	43, 81, 82, 83, 84, 85, 86, 88
0 4103 2669	07974	49
0 4103 2670	28097	50, 87
0 4103 5863	03565	51
0 4103 6367	04029	43, 81, 82, 83, 84, 85, 86, 88
0 4103 6367	07663	44, 81, 84, 86, 87
0 4129 9921	07663	44, 81, 84, 86, 87
0 4180 0483	04901	57, 81, 82, 83, 84, 85, 86, 88
0 4206 1641	35631	33, 86
0 4206 4826	35631	33, 86
0 4206 4829	45386	16, 87
0 4210 1338	05317	24
0 4210 1367	35631	33, 86
0 4211 7309	45384	34, 87
0 4211 7433	45381	19, 87
0 4211 7435	45386	16, 87
0 4211 7447	45385	20, 87
0 4211 7451	45387	25, 87
0 4211 7455	35631	33, 86
0 4211 7457	45384	34, 87
0 4211 7465	46135	14, 87
0 4211 7503	04029	43, 81, 82, 83, 84, 85, 86, 88
0 4211 9082	48667	13, 87
0 4212 7260	45383	18, 87
0 4212 7262	45382	21, 87
0 4253 4370	15341	27
0 4639 0477	48667	13, 87
0 9380 5743	45019	42
5 0347 6428	45019	42

Ref. - No.		
5 0364 6341	48667	13, 87
5 0407 1276	04900	87
5 0407 1277	04899	11, 42, 84
5 0429 4388	34334	43
5 0435 6518	45019	42
5 0435 6518	04899	11, 42, 84
58 0126 0057	45019	42
passend für / to fit:		
KÄSSBOHRER ACHSEN		
0.174.361.056	03964	56, 81, 85, 88
0.174.361.058	03966	55, 81, 85, 86
0.174.361.105	01244	72, 81, 85, 88
0.274.361.104	01245	73, 81, 82, 83, 84, 85, 86, 88
0.374.361.151	04029	43, 81, 82, 83, 84, 85, 86, 88
6.125.311.002	03558	57, 81, 82, 83, 84, 85, 86, 88
8.241.000.483	01279	67, 84, 88
8.241.000.989	05210	40, 84, 88
8.241.016.242	01277	40, 88
8.241.016.243	03205	68, 88
8.241.021.358	05391	66, 88
8.241.999.113	05208	40, 88
8.241.999.615	05207	88
8.241.999.726	05211	45, 85, 88
8.900.020.164	07636	74
passend für / to fit:		
LANCIA		
1476244080	12707	4
passend für / to fit:		
MAN		
N1.01101.2840	01244	72, 81, 85, 88
N1.01105.7257	01244	72, 81, 85, 88
N1.01105.7265	03767	57
N1.01105.7265 S1	03558	57, 81, 82, 83, 84, 85, 86, 88
06.11064.0219	02489	65
06.11064.0222	08178	68
06.11064.0320	01561	66, 88
06.11064.2317	01010	65
06.11064.2320	01561	66, 88
06.11184.0320	01561	66, 88

Ref. - No.

Truck
Division 

Ref. - No.



Ref. - No.



06.11185.0317	01010	65
06.11185.0320	01561	66, 88
06.11222.0207	03555	53
06.11222.0209 S1	01221	53
06.11222.0213	03966	55, 81, 85, 86
06.11222.0215	03964	56, 81, 85, 88
06.11222.0217	03767	57
06.11222.0217 S1	03558	57, 81, 82, 83, 84, 85, 86, 88
06.11222.0218	04901	57, 81, 82, 83, 84, 85, 86, 88
06.11222.0307	03555	53
06.11222.0309	01221	53
06.11222.0309	07400	54
06.11222.0311	03582	55
06.11222.0317	03767	57
06.11222.0317 S1	03558	57, 81, 82, 83, 84, 85, 86, 88
06.11222.0318	03767	57
06.11222.0318 S1	03558	57, 81, 82, 83, 84, 85, 86, 88
06.11222.0416	03182	56, 89
06.11222.6309	07400	54
06.11222.6309 S1	01221	53
06.11222.6507 S1	03555	53
06.11229.0021	03767	57
06.11229.0021	04901	57, 81, 82, 83, 84, 85, 86, 88
06.11229.0021 S1	03558	57, 81, 82, 83, 84, 85, 86, 88
06.11289.0003	02423	56
81.45421.0003	01210	79
81.45421.0004	02825	80
81.45421.0022	02825	80
81.45421.0026	01210	79
81.45421.0029	03804	79
81.45421.0033	05681	80
81.45421.0036	02825	80
81.45422.0008	01983	75, 89
81.45422.0008 S1	01205	89
81.45422.0009	01985	76, 89
81.45422.0009 S1	01207	89
81.45422.0023	03554	76, 89

81.45422.0023 S1	03527	89
81.45422.0024	01984	75, 89
81.45422.0024 S1	01206	89
81.45422.0025	05687	75, 89
81.45422.0025 S1	05659	89
81.45422.0027	01986	76, 89
81.45422.0027 S1	01839	89
81.45422.0030	05684	75, 89
81.45422.0030 S1	05672	89
81.45422.0031	01983	75, 89
81.45422.0031 S1	01205	89
81.45422.0032	05684	75, 89
81.45422.0032 S1	05672	89
81.45422.0033	05687	75, 89
81.45422.0033 S1	05659	89
81.45422.0036	01984	75, 89
81.45422.0036 S1	01206	89
81.45422.0037	03554	76, 89
81.45422.0037 S1	03527	89
81.45422.0040	01985	76, 89
81.45422.0040 S1	01207	89
81.45422.0042	05684	75, 89
81.45422.0046	05691	77, 89
81.45422.0046 S1	05660	89
81.45422.0060	05693	78, 89
81.45422.0060 S1	05678	89
81.45423.0007	03182	56, 89
81.45423.0027	03641	55, 89
81.45501.0058	03997	23, 84
81.45501.0058	14041	21, 86
81.45501.0059	12871	29, 85, 86
81.45501.0059	03960	29, 83
81.45501.0060	03552	30, 82
81.45501.0067	03740	31, 82
81.45501.0067	12873	32, 86
81.45501.0072	03960	29, 83
81.45501.0072	12871	29, 85, 86
81.45501.0076	06287	84
81.45501.0076	14041	21, 86
81.45501.0076 S	18693	23
81.45501.0076 S1	03997	23, 84
81.45501.0076 S2	06287	84
81.45501.0076 S3	18693	23



Ref. - No.		
81.45501.0078	03958	26, 82, 83
81.45501.0079	03958	26, 82, 83
81.45501.0080	12871	29, 85, 86
81.45501.0080	03960	29, 83
81.45501.0081	03552	30, 82
81.45501.0081 S	18694	31
81.45501.0082	03740	31, 82
81.45501.0082	12873	32, 86
81.45501.0083	03961	33, 83
81.45501.0084	03962	34, 83
81.45501.0087	04574	15, 84
81.45501.0094	04574	15, 84
81.45501.0114	12868	23, 85
81.45501.0129	15170	18
81.45501.0131	43538	31, 86
81.45501.0133	12868	23, 85
81.45501.0134	14041	21, 86
81.45501.0137	03958	26, 82, 83
81.45501.0137 S2	06289	82, 83
81.45501.0139	12871	29, 85, 86
81.45501.0139	03960	29, 83
81.45501.0140	03552	30, 82
81.45501.0140	18694	31
81.45501.0141	12873	32, 86
81.45501.0141	03740	31, 82
81.45501.0142	03961	33, 83
81.45501.0143	03962	34, 83
81.45501.0163	12868	23, 85
81.45501.0164	12868	23, 85
81.45501.0174	44322	22, 87
81.45501.0174	12868	23, 85
81.45501.0176	43538	31, 86
81.45502.0000	01244	72, 81, 85, 88
81.45502.0001	01245	73, 81, 82, 83, 84, 85, 86, 88
81.45502.0007	01244	72, 81, 85, 88
81.45502.0008	01244	72, 81, 85, 88
81.45503.0000	03964	56, 81, 85, 88
81.45503.0002 S1	01221	53
81.45503.0006	03767	57
81.45503.0006 S1	03558	57, 81, 82, 83, 84, 85, 86, 88
81.45503.0018	03555	53

Ref. - No.		
81.45503.0019	03582	55
81.45503.0020	03966	55, 81, 85, 86
81.45503.0021 S1	03555	53
81.45503.0022 S1	01221	53
81.45503.0025	07428	54
81.45503.0026	04029	43, 81, 82, 83, 84, 85, 86, 88
81.45503.0027	03641	55, 89
81.45503.0029	04899	11, 42, 84
81.45503.0030	04900	87
81.45503.0030	45149	43
81.45503.0032	45149	43
81.45503.0033	03799	48
81.45503.0034	04689	49
81.45503.0047	04899	11, 42, 84
81.45503.0047	26828	42
81.45503.0048	45149	43
81.45503.0048	04900	87
81.45503.0049	04029	43, 81, 82, 83, 84, 85, 86, 88
81.45503.0049	07663	44, 81, 84, 86, 87
81.45503.0054	03799	48
81.45503.0055	04689	49
81.45503.0056	07663	44, 81, 84, 86, 87
81.45503.0056	04029	43, 81, 82, 83, 84, 85, 86, 88
81.45503.0057 S1	03799	48
81.45503.0058	46788	50
81.45503.0061	04900	87
81.45503.0061	45149	43
81.45503.0062	26828	42
81.45504.0007	01346	70, 81, 82, 83, 85, 86
81.45504.0008	01346	70, 81, 82, 83, 85, 86
81.91320.0048	03517	89
81.91320.0051	03517	89
87.11043.2600	01561	66, 88
passend für / to fit:		
MERCEDES-BENZ AXSEN		
000 401 06 72	07663	44, 81, 84, 86, 87
389 401 00 71 S2	12868	23, 85
942 401 02 71	05524	19, 84

Ref. - No.

Truck
Division 

Ref. - No.



Ref. - No.



942 401 02 71 S1	27544	84
942 401 03 71 S1	27545	84

passend für / to fit:

MERCEDES-BENZ LKW

000125 021000	08310	89
000934 020001	01561	66, 88
000934 020008	01561	66, 88
074361 014101	01214	10, 60
074361 014201	01221	53
074361 014202	03556	10, 53, 81
074361 014204	03556	10, 53, 81
074361 014205	22474	9, 54
074361 014351	01241	72, 81
074361 014353	01241	72, 81
074361 018201	03966	55, 81, 85, 86
074361 018205	03966	55, 81, 85, 86
074361 018250	01243	72, 81, 85
074361 018350	01243	72, 81, 85
074361 018352	01243	72, 81, 85
074361 020204	03964	56, 81, 85, 88
074361 020205	03964	56, 81, 85, 88
074361 020351	01244	72, 81, 85, 88
074361 020352	01244	72, 81, 85, 88
074361 022203	03558	57, 81, 82, 83, 84, 85, 86, 88
074361 022204	03558	57, 81, 82, 83, 84, 85, 86, 88
074361 022205	04901	57, 81, 82, 83, 84, 85, 86, 88
074361 022350	01245	73, 81, 82, 83, 84, 85, 86, 88
074361 022351	01245	73, 81, 82, 83, 84, 85, 86, 88
074361 022352	01245	73, 81, 82, 83, 84, 85, 86, 88
385 400 01 24	04029	43, 81, 82, 83, 84, 85, 86, 88
617 400 00 24	04029	43, 81, 82, 83, 84, 85, 86, 88
304 401 00 69	01210	79
304 401 01 69	01210	79
346 401 50 69	05680	79
387 401 00 69	03804	79

387 401 01 69	01210	79
620 401 01 69	04916	80
315 401 00 70	01983	75, 89
315 401 00 70 kpl.	01205	89
335 401 00 70 S1	05672	89
335 401 00 70	05672	89
335 401 00 70	05684	75, 89
346 401 52 70	03177	77, 89
346 401 52 70 kpl.	03181	89
346 401 53 70 kpl.	05659	89
346 401 53 70	05687	75, 89
387 401 02 70 kpl.	01207	89
387 401 02 70	01985	76, 89
395 401 00 70	05691	77, 89
395 401 00 70 kpl.	05660	89
620 401 00 70 kpl.	08548	89
620 401 00 70	08547	77, 89
620 401 01 70 kpl.	05678	89
620 401 01 70	05693	78, 89
623 401 02 70	03177	77, 89
000 401 23 71	48706	19, 87
000 401 24 71	48707	22, 87
000 401 24 71	12868	23, 85
000 401 29 71	48708	24, 87
000 401 37 71	48709	32, 87
000 401 37 71	29943	32, 86
000 401 38 71	29942	30, 86
000 401 41 71	48710	27, 87
000 401 41 71	05530	27, 84
000 401 44 71	12870	26, 85
305 401 00 71	03997	23, 84
305 401 00 71	06287	84
305 401 00 71	14041	21, 86
309 401 01 71	03176	12, 81
309 401 02 71 S1	06270	81
309 401 02 71	03176	12, 81
309 401 02 71	06270	81
312 401 11 71	01473	15, 81
312 401 11 71	06275	81
314 401 00 71	01654	13, 81
317 401 03 71	03997	23, 84
317 401 04 71	03997	23, 84
318 401 00 71	01473	15, 81



Ref. - No.		
319 401 06 71	03176	12, 81
319 401 08 71	03176	12, 81
319 401 09 71	03176	12, 81
324 401 00 71	12862	13, 85
327 401 00 71	01473	15, 81
327 401 00 71	06275	81
327 401 02 71	03997	23, 84
327 401 04 71	03997	23, 84
327 401 04 71	06287	84
338 401 50 71 KPL/30	07937	81
338 401 50 71 S2	07937	81
338 401 50 71	06281	81
338 401 50 71 S1	06281	81
338 401 50 71	01648	18, 81
338 401 50 71 S	06281	81
346 401 00 71	06293	82
346 401 00 71	03740	31, 82
346 401 00 71	12873	32, 86
355 401 00 71	03552	30, 82
355 401 00 71	06292	82
356 401 00 71	14039	19
381 401 01 71	03997	23, 84
381 401 02 71	03997	23, 84
381 401 03 71	06289	82, 83
381 401 03 71 KPL/MZ	07943	83
381 401 03 71 KPL/30	07942	83
381 401 03 71	03958	26, 82, 83
381 401 03 71 S1	06289	82, 83
381 401 03 71 S3	07943	83
381 401 03 71 S2	07942	83
381 401 04 71	12871	29, 85, 86
381 401 04 71	06291	83
381 401 04 71	03960	29, 83
381 401 05 71 S4	07946	83
381 401 05 71 S3	06291	83
381 401 05 71 S5	07945	83
381 401 05 71 S1	03960	29, 83
381 401 05 71 KPL/MZ	07946	83
381 401 05 71 S	12871	29, 85, 86
381 401 05 71	12871	29, 85, 86
381 401 05 71 KPL/30	07945	83
381 401 05 71	06291	83
381 401 06 71 KPL/MZ	07948	82

Ref. - No.		
381 401 06 71 S3	06292	82
381 401 06 71 S1	03552	30, 82
381 401 06 71	03552	30, 82
381 401 06 71 S1	29942	30, 86
381 401 06 71 S4	07948	82
381 401 06 71 S2	03552	30, 82
381 401 06 71 S6	35502	86
381 401 06 71	06292	82
381 401 06 71 S1	12872	30, 86
381 401 06 71 S2	12872	30, 86
381 401 06 71 S5	07947	82
381 401 06 71	29942	30, 86
381 401 06 71 KPL/30	07947	82
381 401 06 71	12872	30, 86
381 401 07 71	29943	32, 86
381 401 07 71 S2	29943	32, 86
381 401 07 71 S2	03740	31, 82
381 401 07 71 S4	07950	82
381 401 07 71 S3	06293	82
381 401 07 71 KPL/MZ	07950	82
381 401 07 71 KPL/30	07949	82
381 401 07 71 S2	12873	32, 86
381 401 07 71	12873	32, 86
381 401 07 71 S1	12873	32, 86
381 401 07 71	03740	31, 82
381 401 07 71 S5	07949	82
381 401 07 71 S1	29943	32, 86
381 401 07 71 S6	35503	86
381 401 07 71	06293	82
381 401 07 71 S1	03740	31, 82
381 401 08 71 S1	03961	33, 83
381 401 08 71 S2	06294	83
381 401 08 71 KPL/30	07951	83
381 401 08 71	12874	33, 86
381 401 08 71	06294	83
381 401 08 71 S3	07951	83
381 401 11 71	12871	29, 85, 86
381 401 11 71	06291	83
381 401 12 71 S1	07940	23
381 401 12 71 S2	12869	24, 85
381 401 13 71 S1	07953	34
381 401 13 71	12875	35
389 401 00 71 S5	07939	84

Ref. - No.

Truck
Division 

Ref. - No.



Ref. - No.



389 401 00 71 KPL/MZ	07939	84
389 401 00 71 S4	07938	84
389 401 00 71 S6	44322	22, 87
389 401 00 71	03997	23, 84
389 401 00 71	06287	84
389 401 00 71 S1	03997	23, 84
389 401 00 71 S2	12868	23, 85
389 401 00 71 KPL/30	07938	84
389 401 00 71 S3	06287	84
389 401 01 71	12870	26, 85
389 401 01 71 S1	07944	26, 85
498 401 00 71	12871	29, 85, 86
498 401 00 71	06291	83
498 401 00 71	03960	29, 83
677 401 00 71	21583	17
942 401 02 71 S1	27544	84
942 401 02 71	05524	19, 84
942 401 03 71	05530	27, 84
942 401 03 71	48710	27, 87
942 401 03 71 S1	27545	84
948 401 00 71	29418	25
948 401 02 71	12869	24, 85
948 401 02 71	07940	23
948 401 02 71	29418	25
970 401 00 71	32043	12
976 401 01 71	21583	17
976 401 02 71	21583	17
000 401 06 72	07663	44, 81, 84, 86, 87
000 401 10 72 S1	04689	49
000 401 10 72	04689	49
000 401 13 72	28097	50, 87
346 401 50 72	03182	56, 89
608 401 00 72	01214	10, 60
304 402 00 68	02825	80
304 402 01 68	02825	80
304 402 02 68	02825	80
331 402 00 68	02825	80
346 402 51 68	02825	80
387 402 01 68	02825	80
387 402 02 68	02825	80
620 402 00 68	05681	80
304 402 02 70	01985	76, 89
315 402 00 70	01985	76, 89

315 402 00 70 kpl.	01207	89
315 402 01 70 kpl.	03527	89
315 402 01 70	03554	76, 89
315 402 02 70 kpl.	01206	89
315 402 02 70	01984	75, 89
317 402 01 70	03177	77, 89
346 402 50 70	03554	76, 89
363 402 01 70	05672	89
363 402 01 70	05684	75, 89
387 402 00 70	01984	75, 89
387 402 02 70	01983	75, 89
387 402 04 70	05687	75, 89
387 402 04 70 kpl.	05659	89
387 402 05 70 kpl.	01839	89
387 402 05 70	01986	76, 89
302 402 00 71	02666	16, 81
304 402 02 71 KPL/30	07955	88
304 402 02 71	01457	39, 88
304 402 02 71 S1	06297	88
304 402 02 71	06297	88
304 402 02 71 S2	07955	88
309 402 01 71	01471	12, 81
309 402 02 71	01471	12, 81
309 402 02 71 S1	06271	81
309 402 02 71	06271	81
312 402 10 71	03125	15, 81
314 402 00 71 S1	01654	13, 81
314 402 00 71	12862	13, 85
314 402 00 71	06273	81
314 402 00 71 S2	06272	81
314 402 00 71 S3	06273	81
314 402 00 71	06272	81
317 402 05 71	03958	26, 82, 83
318 402 00 71	12863	14, 85
318 402 00 71	06274	81
318 402 00 71 S1	01647	14, 81
318 402 00 71 S2	06274	81
318 402 02 71 S1	01473	15, 81
318 402 02 71	06275	81
318 402 02 71 S2	06275	81
319 402 01 71	01471	12, 81
319 402 03 71	01471	12, 81
319 402 04 71	01471	12, 81



Ref. - No.		
324 402 00 71	01654	13, 81
327 402 02 71	12866	16, 85
327 402 02 71 S2	06279	81
327 402 02 71 S1	02666	16, 81
327 402 02 71	06279	81
327 402 03 71 KOMPL.	06280	81
327 402 03 71 S2	06280	81
327 402 03 71	12867	17, 85
327 402 03 71 S1	01474	17, 81
327 402 04 71	03958	26, 82, 83
352 402 00 71	06278	81
352 402 00 71 S2	06278	81
352 402 00 71 S1	01429	15, 81
352 402 00 71	12865	16, 85
352 402 01 71	06277	81
352 402 01 71	03125	15, 81
352 402 01 71 S1	06277	81
674 402 01 71	09298	14
066 402 00 75	01345	70, 81, 85
317 402 01 75	01346	70, 81, 82, 83, 85, 86
319 402 00 75	01472	70, 81
6.125.312.233	19331	18, 86
620 990 02 40	08310	89
000 990 14 50	03641	55, 89
000 990 50 53	26828	42
000 990 51 53	45149	43
000 990 61 53	45149	43
000 994 22 60	03517	89
324 997 00 26	01656	70, 81, 85
passend für / to fit:		
MERCEDES-BENZ PKW		
000934 014006	01010	65
000934 014019	01010	65
074361 014205	22474	9
308673 014001	01010	65
163 401 00 70	18913	3
163 401 03 70	18913	3
163 401 06 70	18913	3
211 401 03 70	18913	3
601 401 02 70	08237	4
601 401 03 70	08237	4
901 401 00 70	24645	5

Ref. - No.		
309 401 01 71	03176	81
309 401 02 71	03176	81
314 401 00 71	01654	81
319 401 06 71	03176	81
319 401 08 71	03176	81
319 401 09 71	03176	81
324 401 00 71	12862	85
638 401 00 71	09805	2
638 401 01 71	09806	6
638 401 02 71	09805	2
309 402 01 71	01471	12, 81
309 402 02 71	01471	12, 81
314 402 00 71 S1	01654	81
314 402 00 71	12862	85
319 402 01 71	01471	12, 81
319 402 03 71	01471	12, 81
319 402 04 71	01471	12, 81
324 402 00 71	01654	81
000 990 24 07	29466	4
000 990 49 07	18913	3
000 990 67 07	18913	3
000 990 69 07	18913	3
000 990 72 07	18913	3
000 990 79 07	18913	3
000 990 83 07 S1	18913	3
000 990 98 07	18913	3
906 990 00 07	09806	6
110 990 00 59	03857	60
120 990 00 59	03857	60
passend für / to fit:		
NEOPLAN		
N1.01101.2840	01244	72, 81, 85, 88
N1.01101.3141	15341	27
N1.01105.7257	01244	72, 81, 85, 88
N1.01105.7265	03767	57
N1.01105.7265 S1	03558	57, 81, 82, 83, 84, 85, 86, 88
06.11064.0320	01561	66, 88
06.11064.2320	01561	66, 88
06.11184.0320	01561	66, 88
06.11185.0320	01561	66, 88
06.11222.0217	03767	57

Ref. - No.

Truck
Division 

Ref. - No.



Ref. - No.



06.11222.0217 S1	03558	57, 81, 82, 83, 84, 85, 86, 88
06.11222.0317	03767	57
06.11222.0317 S1	03558	57, 81, 82, 83, 84, 85, 86, 88
06.11222.0318	03767	57
06.11222.0318 S1	03558	57, 81, 82, 83, 84, 85, 86, 88
06.11229.0021	03767	57
06.11229.0021 S1	03558	57, 81, 82, 83, 84, 85, 86, 88
0701 104 07	05901	71, 84
0701.300.00	03767	57
0801.116.26 S	18693	23
0821.210.19 S	18694	31
5290 022 00	01245	73, 81, 82, 83, 84, 85, 86, 88
5290 050 00	03767	57
81.45501.0129	15170	18
81.45501.0133	12868	23, 85
81.45502.0000	01244	72, 81, 85, 88
81.45502.0007	01244	72, 81, 85, 88
81.45502.0008	01244	72, 81, 85, 88
81.45503.0006	03767	57
81.45503.0006 S1	03558	57, 81, 82, 83, 84, 85, 86, 88
81.45503.0058	46788	50
87.11043.2600	01561	66, 88
passend für / to fit:		
OPEL		
4412 908	26747	5
4414 784	26747	5
4418 227	26747	5
passend für / to fit:		
PEUGEOT		
16 087 344 80	30400	1
5405.30	12706	3
5405.35	11616	1
5405.48	12707	4
5405.55	11616	1
5405.59	11616	1
5405.66	21175	1
5405.67	29208	1

5405.68	32439	4
5405.72	30400	1
5405.75	32440	3
5405.76	32450	6
5405.78	32441	5
5405.79	32442	7
5405.81	11939	8
5405.84	21175	1
5405.88	32441	5
passend für / to fit:		
RENAULT (RVI)		
00 00 190 220	10444	28
00 00 190 221	10445	21
00 03 156 050	03794	45, 85
00 21 623 013	03794	45, 85
00 21 623 307	03794	45, 85
00 21 623 312	03794	45, 85
50 00 029 513	03794	45, 85
50 00 351 162	18826	17
50 00 471 836	03794	45, 85
50 00 471 855	03794	45, 85
50 00 471 861	03794	45, 85
50 00 543 465	03794	45, 85
50 00 545 223	03794	45, 85
50 00 556 773	03794	45, 85
50 00 604 165	03794	45, 85
50 00 605 522	03794	45, 85
50 00 653 117	03794	45, 85
50 00 737 601	27796	20
50 00 786 926	03794	45, 85
50 00 788 677	03794	45, 85
50 10 097 347	24241	44
50 10 262 935	24241	44
50 10 262 936	26828	42
50 10 319 141	10445	21
50 10 439 317	18825	29, 86
50 10 439 406	24779	35
50 10 439 406	18825	29, 86
50 10 457 733	24241	44
74 20 515 514	32796	22
74 20 515 515	32797	25
74 20 515 517	32798	28
74 20 515 518	44311	29, 86, 87

Ref. - No.

74 20 515 519	32799	31
74 20 524 942	32801	33, 86
74 20 551 045	24626	44, 86, 87
74 20 553 560	32800	34
74 21 147 687	32801	33, 86
74 21 303 956	24626	44, 86, 87
74 21 402 076	24626	44, 86, 87

passend für / to fit:

RENAULT

50 10 262 936	26828	42
77 00 437 514	02062	2
77 00 668 275	02062	2
82 00 030 701	02062	2
82 00 366 209	26747	5
82 00 639 129	26747	5

passend für / to fit:

ROR

21006511	04938	67, 81, 84, 88
21006511PK10	04938	67, 81, 84, 88
21006512	01245	73, 81, 82, 83, 84, 85, 86, 88
21016417	03848	69, 82
21022167	02504	25, 81
21022167 CPL	02505	81
21022167K	02505	81
21022167PK10	02504	25, 81
21203099	04029	43, 81, 82, 83, 84, 85, 86, 88
21218643	05211	45, 85, 88

passend für / to fit:

ROVER

NAM 9077	03427	8
----------	--------------	---

passend für / to fit:

SAF

1 303 1008 10	01275	40, 88
1 303 1008 11	01275	40, 88
1 303 1028 10	01277	40, 88
1 303 1028 11	01277	40, 88
1 303 1040 10	05751	39, 88
1 303 1040 11	05751	39, 88
1 303 1045 10	05746	39, 88
1 303 1045 11	05746	39, 88
1 303 1048 10	05746	39, 88

Ref. - No.

1 303 1049 10	05751	39, 88
1 303 1074 10	02406	22, 81
1 303 1074 11	02406	22, 81
1 303 1074 12	02406	22, 81
1 303 1074 13	02406	22, 81
1 303 1075 10	02407	27, 81
1 303 1075 11	02407	27, 81
1 303 1075 12	02407	27, 81
1 303 1445 11	05746	39, 88
2 247 3010 01	03794	45, 85
2 247 3021 00	07301	46, 88
3 302 1008 00	04233	88
3 302 1028 00	01278	88
3 302 1040 00	05750	88
3 302 1045 00	05745	88
3 302 1077 00	01834	81
3 302 1078 00	06465	81
3 302 1126 00	01833	81
4 141 1002 00	01244	72, 81, 85, 88
4 141 1003 00	01245	73, 81, 82, 83, 84, 85, 86, 88
4 247 3012 00	04029	43, 81, 82, 83, 84, 85, 86, 88
4 247 3012 01	07663	44, 81, 84, 86, 87
4 247 3012 01	22777	45
4 247 3023 10	03848	69, 82
4 316 2005 00	01832	81
4 342 0008 10	05391	66, 88
4 342 0009 10	01279	67, 84, 88
4 342 0011 80	08178	68
4 342 0015 00	01280	67, 88
4 342 0015 10	01280	67, 88
4 342 0019 00	06425	67, 88
4 342 0019 10	06425	67, 88
4 342 0020 10	04938	67, 81, 84, 88

passend für / to fit:

SCANIA

0 120 912	03848	69, 82
0 121 306	03851	69, 82
0 123 249	03842	36, 82
0 123 250	03843	36, 82
0 132 601	03844	37, 82
0 132 602	03845	37, 82

Ref. - No.

Truck
Division 

Ref. - No.



Ref. - No.



0 143 962	01985	76, 89
0 143 962 S1	01207	89
0 228 632	01983	75, 89
0 228 632 S1	01205	89
0 228 633	01210	79
0 228 634	01985	76, 89
0 230 339 S1	01206	89
0 243 955	05160	47, 82
0 243 956	14959	47, 82, 85, 86
0 265 446	03517	89
0 265 447	03641	55, 89
0 272 853	05915	37
0 278 874	05681	80
0 279 574	03182	56, 89
0 288 799	14963	77, 89
0 289 535	05693	78, 89
0 289 535 S1	05678	89
0 290 062	05916	36
0 290 405	08310	89
0 293 493	03177	77, 89
0 293 493 S1	03181	89
0 293 495	05680	79
0 295 953	05917	36, 85
0 295 953	14853	35, 86
0 318 690	14959	47, 82, 85, 86
0 338 883	08547	77, 89
0 338 883 S1	08548	89
0 338 884	04916	80
0 397 266	05916	36
1 365 510	14959	47, 82, 85, 86
1 368 690	05916	36
1 368 693	14853	35, 86
1 382 496	04916	80
1 749 034	14959	47, 82, 85, 86
1 868 665	40510	35, 86
passend für / to fit:		
SEAT		
WHT 001 812	09801	3
WHT 002 437	09801	3
3A0 601 139	06963	2
321 601 139 C	06963	2
431 601 139 A	09801	3
443 601 139 A	09801	3

443 601 139 C	09801	3
7M0 601 139 A	04912	5
7M3 601 139 B	17818	6
701 601 139	04912	5
701 601 139 B	04912	5
8D0 601 139 A	09801	3
8D0 601 139 D	09801	3
passend für / to fit:		
TRAILOR		
143 8000 A	03966	55, 81, 85, 86
601 3000 G	08048	59
649 7000 L	03794	45, 85
650 2798 G	07312	20, 85
650 2799 J	07304	26, 85
700 0016 A	03794	45, 85
passend für / to fit:		
TRILEX		
02-018	03804	79
02 - 067	01210	79
02 - 110	05681	80
02-120	03804	79
02 - 128	05681	80
02 - 129	05681	80
02 - 130	05681	80
02-132	03804	79
124-87	01983	75, 89
124-88	05684	75, 89
124-90	05687	75, 89
124-91	01984	75, 89
124-92	01985	76, 89
124-93	03554	76, 89
124-94	01986	76, 89
125-01	05693	78, 89
125-03	05694	78, 89
125-06	05691	77, 89
151 - 12	03641	55, 89
57 T 16	02825	80
58 T 20	01210	79
59 T 46	01983	75, 89
59 T 47	05684	75, 89
59 T 49	01984	75, 89
59 T 54	05687	75, 89
59 T 59	01985	76, 89

Ref. - No.

59 T 60	03554	76, 89
59 T 61	01986	76, 89
659 002 098	05680	79
659 002 101	01210	79
659 002 110	02825	80
659 002 117	03804	79
659 002 129	02825	80
659 002 171	05681	80
659 002 215	04916	80
659 112 450	01983	75, 89
659 112 450 S1	01205	89
659 112 451	05684	75, 89
659 112 451	05672	89
659 112 451 S1	05672	89
659 112 453	05687	75, 89
659 112 453	05659	89
659 112 453 S1	05659	89
659 112 454	01984	75, 89
659 112 454	01206	89
659 112 454 S1	01206	89
659 112 455	01985	76, 89
659 112 455	01207	89
659 112 455 S1	01207	89
659 112 456	03527	89
659 112 456	03554	76, 89
659 112 456 S1	03527	89
659 112 457	01986	76, 89
659 112 457	01839	89
659 112 457 S1	01839	89
659 112 500	03181	89
659 112 500	03177	77, 89
659 112 500 S1	03181	89
659 112 509	05660	89
659 112 509	05691	77, 89
659 112 509 S1	05660	89
659 112 611	14963	77, 89
659 112 611 S1	15686	89
659 112 612	05693	78, 89
659 112 612	05678	89
659 112 612 S1	05678	89
659 112 613	05661	89
659 112 613	05694	78, 89
659 112 613 S1	05661	89

Ref. - No.

659 112 614	24774	78, 89
659 112 614 S1	24775	89
659 112 615	03177	77, 89
659 112 616	08547	77, 89
659 112 616	08548	89
659 112 616 S1	08548	89
659 115 300	03641	55, 89
659 115 304	03182	56, 89
659 120 228	08310	89
659 130 008	03517	89
659 130 014	03517	89
659 130 017	03517	89
78 T 08	03641	55, 89

passend für / to fit:

UNIVERSAL VERWENDBAR NKW

918.24.00	03966	55, 81, 85, 86
-----------	--------------	----------------

passend für / to fit:

VAUXHALL

91169857	26747	5
93853173	26747	5
93858987	26747	5

passend für / to fit:

VOLVO LKW

1083894	04778	47, 81, 84
1573081	05779	37, 84
1573082	05778	38, 84
1577424	05691	77, 89
1581193	05681	80
1581380	03517	89
1581604	05693	78, 89
1588406	08547	77, 89
1588406 S1	08548	89
1589009	03839	38
1594863	03566	51
1594864	03570	52
1608293	05693	78, 89
1608293 S1	05678	89
1626659	12414	46
20515514	32796	22
20515515	32797	25
20515517	32798	28
20515518	44311	29, 86, 87
20515519	32799	31

Ref. - No.



Truck Division 



Ref. - No.



Ref. - No.



20524942	32801	33, 86
20551045	24626	44, 86, 87
20552688	24335	50, 86, 87
20553560	32800	34
20707705	24397	28
21147687	32801	33, 86
21147687 S1	35176	86
21303956	24626	44, 86, 87
21402076	24626	44, 86, 87
21668	02796	46
324567	02825	80
362164	03177	77, 89
362166	03182	56, 89
362167	05680	79
6852475	04487	21, 84
8152104	01230	38, 81
941385	03609	41
943491	04778	47, 81, 84
947970	04899	11, 42, 84
947971	04900	87
947972	04029	43, 81, 82, 83, 84, 85, 86, 88

passend für / to fit:

VOLVO PKW

30870000	11939	8
30873148	11939	8
8665333	27413	7
999359	27413	7

passend für / to fit:

VOLKSWAGEN

N 020 112 1	01214	10, 60
N 020 112 2	01214	10, 60
N 020 115 3	03556	10, 53
N 020 116 1	04899	11, 42, 84
WHT 000 888	29466	4
WHT 001 693	21588	6
WHT 001 812	09801	3
WHT 002 437	09801	3
WHT 002 529	21588	6
WHT 004 676	21588	6
2D0 501 627	03176	81
2D0 601 139	08237	4
211 601 139	01664	2

251 601 139	01664	2
3A0 601 139	06963	2
321 601 139 C	06963	2
431 601 139 A	09801	3
443 601 139 A	09801	3
443 601 139 C	09801	3
7L0 601 139	21588	6
7L0 601 139 A	21588	6
7M0 601 139 A	04912	5
7M3 601 139 B	17818	6
701 601 139	04912	5
701 601 139 B	04912	5
8D0 601 139 A	09801	3
8D0 601 139 D	09801	3

Ref. - No.

01010	-	65
01010	06.11064.2317	65
01010	308673 014001	65
01205	02.5070.24.00 kpl.	89
01205	81.45422.0008 S1	89
01205	315 401 00 70 kpl.	89
01205	0 228 632 S1	89
01205	659 112 450 S1	89
01205	-	89
01206	02.5070.25.00 kpl.	89
01206	81.45422.0036 S1	89
01206	315 402 02 70 kpl.	89
01206	0 230 339 S1	89
01206	659 112 454 S1	89
01206	-	89
01207	02.5070.21.00 kpl.	89
01207	81.45422.0009 S1	89
01207	315 402 00 70 kpl.	89
01207	0 143 962 S1	89
01207	659 112 455 S1	89
01207	-	89
01210	02.1816.04.00	79
01210	81.45421.0026	79
01210	387 401 01 69	79
01210	0 228 633	79
01210	659 002 101	79
01210	-	79
01214	074361 014101	10, 60
01214	N 020 112 1	10, 60
01214	-	10, 60
01221	02.5213.08.82	53
01221	81.45503.0022 S1	53
01221	074361 014201	53
01221	-	53
01230	8152104	38, 81
01241	KZE 0912-05	72, 81
01241	02.5615.14.90	72, 81
01241	-	72, 81
01241	074361 014353	72, 81
01242	-	72
01243	02.5615.18.90	72, 81, 85
01243	-	72, 81, 85
01243	0 0112 1808	72, 81, 85

Ref. - No.

01243	074361 018352	72, 81, 85
01244	02.5615.20.90	72, 81, 85, 88
01244	-	72, 81, 85, 88
01244	074361 020352	72, 81, 85, 88
01244	0 0112 1810	72, 81, 85, 88
01244	0.174.361.105	72, 81, 85, 88
01244	81.45502.0008	72, 81, 85, 88
01244	4 141 1002 00	72, 81, 85, 88
01245	02.5615.22.90	73, 81, 82, 83, 84, 85, 86, 88
01245	0325 235	73, 81, 82, 83, 84, 85, 86, 88
01245	074361 022351	73, 81, 82, 83, 84, 85, 86, 88
01245	0 0112 1811	73, 81, 82, 83, 84, 85, 86, 88
01245	0.274.361.104	73, 81, 82, 83, 84, 85, 86, 88
01245	81.45502.0001	73, 81, 82, 83, 84, 85, 86, 88
01245	5290 022 00	73, 81, 82, 83, 84, 85, 86, 88
01245	21006512	73, 81, 82, 83, 84, 85, 86, 88
01245	4 141 1003 00	73, 81, 82, 83, 84, 85, 86, 88
01245	-	73, 81, 82, 83, 84, 85, 86, 88
01273	03.296.12.04.0	39, 88
01274	09.806.12.03.0	88
01275	03.296.23.05.0	40, 88
01275	1 303 1008 11	40, 88
01276	09.806.23.09.0	88
01277	03.296.13.09.0	40, 88
01277	8.241.016.242	40, 88
01277	1 303 1028 11	40, 88
01278	09.806.13.02.0	88
01278	3 302 1028 00	88
01279	03.260.04.06.0	67, 84, 88
01279	-	67, 84, 88
01279	8.241.000.483	67, 84, 88
01279	4 342 0009 10	67, 84, 88
01280	03.260.04.01.0	67, 88



Ref. - No.

Truck
Division 

Ref. - No.



Ref. - No.



01280	0144 922	67, 88
01280	-	67, 88
01280	4 342 0015 10	67, 88
01345	03.310.10.02.0	70, 81, 85
01345	-	70, 81, 85
01345	0 0341 4228	70, 81, 85
01345	066 402 00 75	70, 81, 85
01346	0260 261	70, 81, 82, 83, 85, 86
01346	317 402 01 75	70, 81, 82, 83, 85, 86
01346	0 0342 0371	70, 81, 82, 83, 85, 86
01346	81.45504.0007	70, 81, 82, 83, 85, 86
01346	-	70, 81, 82, 83, 85, 86
01429	352 402 00 71 S1	15, 81
01457	304 402 02 71	39, 88
01471	05103938AA	81
01471	309 402 02 71	12, 81
01472	05103941AA	70, 81
01472	-	70, 81
01472	319 402 00 75	70, 81
01473	318 402 02 71 S1	15, 81
01474	327 402 03 71 S1	17, 81
01561	-	66, 88
01561	000934 020008	66, 88
01561	06.11064.2320	66, 88
01647	318 402 00 71 S1	14, 81
01648	338 401 50 71	18, 81
01654	314 402 00 71 S1	13, 81
01654	314 402 00 71 S1	81
01656	--	70, 81, 85
01656	0 0247 8940	70, 81, 85
01656	324 997 00 26	70, 81, 85
01656	-	70, 81, 85
01664	251 601 139	2
01832	-	81
01832	4 316 2005 00	81
01833	3 302 1126 00	81
01834	3 302 1077 00	81
01839	02.5070.23.00 kpl.	89

01839	81.45422.0027 S1	89
01839	387 402 05 70 kpl.	89
01839	659 112 457 S1	89
01839	-	89
01983	02.5070.24.00	75, 89
01983	81.45422.0008	75, 89
01983	315 401 00 70	75, 89
01983	0 228 632	75, 89
01983	659 112 450	75, 89
01983	-	75, 89
01984	02.5070.25.00	75, 89
01984	81.45422.0024	75, 89
01984	315 402 02 70	75, 89
01984	659 112 454	75, 89
01984	-	75, 89
01985	02.5070.21.00	76, 89
01985	81.45422.0009	76, 89
01985	315 402 00 70	76, 89
01985	0 143 962	76, 89
01985	659 112 455	76, 89
01985	-	76, 89
01986	02.5070.23.00	76, 89
01986	81.45422.0027	76, 89
01986	387 402 05 70	76, 89
01986	659 112 457	76, 89
01986	-	76, 89
02062	40222-BC40A	2
02062	82 00 030 701	2
02406	1 303 1074 12	22, 81
02407	1 303 1075 12	27, 81
02423	06.11289.0003	56
02489	-	65
02489	06.11064.0219	65
02504	21022167PK10	25, 81
02505	21022167K	81
02523	09.806.13.30.0	88
02666	327 402 02 71 S1	16, 81
02796	-	46
02796	21668	46
02825	81.45421.0036	80
02825	387 402 02 68	80
02825	659 002 129	80
02825	-	80

Ref. - No.

02825	324567	80
03125	352 402 01 71	15, 81
03176	05139905AA	81
03176	309 401 02 71	12, 81
03176	309 401 02 71	81
03176	2D0 501 627	81
03177	02.5070.47.00	77, 89
03177	-	77, 89
03177	346 401 52 70	77, 89
03177	0 293 493	77, 89
03177	659 112 615	77, 89
03177	362164	77, 89
03181	02.5070.47.00 kpl.	89
03181	-	89
03181	346 401 52 70 kpl.	89
03181	0 293 493 S1	89
03181	659 112 500 S1	89
03182	02.5270.04.00	56, 89
03182	0678 250	56, 89
03182	06.11222.0416	56, 89
03182	346 401 50 72	56, 89
03182	0 279 574	56, 89
03182	659 115 304	56, 89
03182	-	56, 89
03182	362166	56, 89
03205	03.260.04.02.0	68, 88
03205	-	68, 88
03205	8.241.016.243	68, 88
03210	09.806.13.14.0	88
03210	-	88
03427	1 366 029	8
03427	81EB1K024AB	8
03427	NAM 9077	8
03427	-	8
03517	02.1818.10.00	89
03517	0506 666	89
03517	81.91320.0051	89
03517	000 994 22 60	89
03517	0 265 446	89
03517	659 130 017	89
03517	-	89
03517	1581380	89
03527	02.5070.22.00 kpl.	89

Ref. - No.

03527	81.45422.0023 S1	89
03527	315 402 01 70 kpl.	89
03527	659 112 456 S1	89
03527	-	89
03552	381 401 06 71 S1	30, 82
03552	81.45501.0081	30, 82
03554	02.5070.22.00	76, 89
03554	81.45422.0023	76, 89
03554	315 402 01 70	76, 89
03554	659 112 456	76, 89
03554	-	76, 89
03555	06.11222.6507 S1	53
03555	-	53
03556	KZE 0912-06	10, 53, 81
03556	-	10, 53, 81
03556	074361 014202	10, 53, 81
03556	N 020 115 3	10, 53
03558	02.5213.16.10	57, 81, 82, 83, 84, 85, 86, 88
03558	074361 022203	57, 81, 82, 83, 84, 85, 86, 88
03558	0 0112 1800	57, 81, 82, 83, 84, 85, 86, 88
03558	6.125.311.002	57, 81, 82, 83, 84, 85, 86, 88
03558	06.11229.0021 S1	57, 81, 82, 83, 84, 85, 86, 88
03558	-	57, 81, 82, 83, 84, 85, 86, 88
03565	0 4103 5863	51
03565	-	51
03566	-	51
03566	1594863	51
03569	-	51
03570	-	52
03570	1594864	52
03582	06.11222.0311	55
03582	-	55
03609	941385	41
03641	02.5270.03.00	55, 89
03641	81.45503.0027	55, 89
03641	000 990 14 50	55, 89
03641	0 265 447	55, 89



Ref. - No.

Truck Division 



Ref. - No.



Ref. - No.



03641	659 115 300	55, 89
03641	-	55, 89
03722	-	63
03730	-	64
03736	-	62
03740	381 401 07 71 S1	31, 82
03740	81.45501.0082	31, 82
03748	-	62
03749	-	63
03767	06.11229.0021	57
03767	5290 050 00	57
03767	-	57
03774	-	61
03791	-	63
03794	A-JA-0495-001	45, 85
03794	50 00 788 677	45, 85
03794	2 247 3010 01	45, 85
03794	649 7000 L	45, 85
03794	-	45, 85
03799	02.5219.33.10	48
03799	1263 487	48
03799	81.45503.0057 S1	48
03799	-	48
03804	81.45421.0029	79
03804	387 401 00 69	79
03804	659 002 117	79
03804	-	79
03839	1589009	38
03842	0 123 249	36, 82
03843	0 123 250	36, 82
03844	0 132 601	37, 82
03845	0 132 602	37, 82
03848	21016417	69, 82
03848	4 247 3023 10	69, 82
03848	0 120 912	69, 82
03848	-	69, 82
03851	0 121 306	69, 82
03851	-	69, 82
03857	110 990 00 59	60
03857	-	60
03869	-	63
03870	-	64
03958	381 401 03 71	26, 82, 83

03958	81.45501.0079	26, 82, 83
03960	381 401 05 71 S1	29, 83
03960	81.45501.0080	29, 83
03961	381 401 08 71 S1	33, 83
03961	81.45501.0083	33, 83
03962	81.45501.0084	34, 83
03964	02.5213.14.10	56, 81, 85, 88
03964	0 0112 1798	56, 81, 85, 88
03964	0.174.361.056	56, 81, 85, 88
03964	06.11222.0215	56, 81, 85, 88
03964	074361 020205	56, 81, 85, 88
03964	-	56, 81, 85, 88
03966	02.5213.12.10	55, 81, 85, 86
03966	0.174.361.058	55, 81, 85, 86
03966	06.11222.0213	55, 81, 85, 86
03966	074361 018205	55, 81, 85, 86
03966	-	55, 81, 85, 86
03966	143 8000 A	55, 81, 85, 86
03980	09.806.23.27.0	88
03980	-	88
03981	09.806.23.28.0	84
03981	-	84
03997	389 401 00 71 S1	23, 84
03997	81.45501.0076 S1	23, 84
04029	02.5219.22.10	43, 81, 82, 83, 84, 85, 86, 88
04029	0620 652	43, 81, 82, 83, 84, 85, 86, 88
04029	385 400 01 24	43, 81, 82, 83, 84, 85, 86, 88
04029	0 4103 6367	43, 81, 82, 83, 84, 85, 86, 88
04029	0.374.361.151	43, 81, 82, 83, 84, 85, 86, 88
04029	81.45503.0026	43, 81, 82, 83, 84, 85, 86, 88
04029	-	43, 81, 82, 83, 84, 85, 86, 88
04029	21203099	43, 81, 82, 83, 84, 85, 86, 88
04029	4 247 3012 00	43, 81, 82, 83, 84, 85, 86, 88

Ref. - No.

04029	3.854.000.124	43, 81, 82, 83, 84, 85, 86, 88
04029	947972	43, 81, 82, 83, 84, 85, 86, 88
04227	02.5214.14.10	62
04227	-	62
04233	09.806.23.02.0	88
04233	3 302 1008 00	88
04235	02.5214.12.10	61
04235	-	61
04237	02.5214.16.10	62
04237	-	62
04487	6852475	21, 84
04573	0 0247 7764	32
04574	81.45501.0094	15, 84
04689	02.5219.34.10	49
04689	1263 488	49
04689	000 401 10 72 S1	49
04689	81.45503.0055	49
04689	-	49
04778	-	47, 81, 84
04778	1083894	47, 81, 84
04781	03.296.00.03.0	12
04899	02.5219.18.10	11, 42, 84
04899	5 0435 6518	11, 42, 84
04899	81.45503.0029	11, 42, 84
04899	-	11, 42, 84
04899	947970	11, 42, 84
04899	N 020 116 1	11, 42, 84
04900	02.5219.20.10	87
04900	5 0407 1276	87
04900	81.45503.0030	87
04900	-	87
04900	947971	87
04901	03.260.54.03.0	57, 81, 82, 83, 84, 85, 86, 88
04901	074361 022205	57, 81, 82, 83, 84, 85, 86, 88
04901	0 4180 0483	57, 81, 82, 83, 84, 85, 86, 88
04901	06.11222.0218	57, 81, 82, 83, 84, 85, 86, 88

Ref. - No.

04901	-	57, 81, 82, 83, 84, 85, 86, 88
04912	7 201 016	5
04912	95VW1107AB	5
04912	701 601 139 B	5
04916	620 401 01 69	80
04916	1 382 496	80
04916	659 002 215	80
04916	-	80
04938	03.260.04.12.0	67, 81, 84, 88
04938	-	67, 81, 84, 88
04938	21006511PK10	67, 81, 84, 88
04938	4 342 0020 10	67, 81, 84, 88
05160	0 243 955	47, 82
05160	-	47, 82
05207	09.806.23.18.0	88
05207	8.241.999.615	88
05208	03.296.23.15.0	40, 88
05208	8.241.999.113	40, 88
05209	09.806.23.21.0	88
05209	-	88
05210	03.296.23.17.0	40, 84, 88
05210	8.241.000.989	40, 84, 88
05211	02.5219.23.10	45, 85, 88
05211	1826 088	45, 85, 88
05211	8.241.999.726	45, 85, 88
05211	21218643	45, 85, 88
05211	-	45, 85, 88
05246	-	60
05247	-	61
05317	0 0716 8580	24
05391	03.260.03.05.0	66, 88
05391	-	66, 88
05391	8.241.021.358	66, 88
05391	4 342 0008 10	66, 88
05524	942 401 02 71	19, 84
05530	942 401 03 71	27, 84
05659	81.45422.0025 S1	89
05659	387 402 04 70 kpl.	89
05659	659 112 453 S1	89
05659	-	89
05660	81.45422.0046 S1	89
05660	395 401 00 70 kpl.	89



Ref. - No.

Truck Division 



Ref. - No.



Ref. - No.



05660	659 112 509 S1	89
05660	-	89
05661	02.5070.87.00 kpl.	89
05661	-	89
05661	659 112 613 S1	89
05672	81.45422.0030 S1	89
05672	335 401 00 70 S1	89
05672	659 112 451 S1	89
05672	-	89
05678	02.5070.32.00 kpl.	89
05678	81.45422.0060 S1	89
05678	620 401 01 70 kpl.	89
05678	0 289 535 S1	89
05678	659 112 612 S1	89
05678	-	89
05678	1608293 S1	89
05680	02.1816.12.00	79
05680	-	79
05680	346 401 50 69	79
05680	0 293 495	79
05680	659 002 098	79
05680	362167	79
05681	02.1816.14.00	80
05681	81.45421.0033	80
05681	620 402 00 68	80
05681	0 278 874	80
05681	659 002 171	80
05681	-	80
05681	1581193	80
05684	81.45422.0030	75, 89
05684	335 401 00 70	75, 89
05684	659 112 451	75, 89
05684	-	75, 89
05687	81.45422.0025	75, 89
05687	387 402 04 70	75, 89
05687	659 112 453	75, 89
05687	-	75, 89
05691	81.45422.0046	77, 89
05691	395 401 00 70	77, 89
05691	659 112 509	77, 89
05691	-	77, 89
05691	1577424	77, 89
05693	02.5070.32.00	78, 89

05693	81.45422.0060	78, 89
05693	620 401 01 70	78, 89
05693	0 289 535	78, 89
05693	659 112 612	78, 89
05693	-	78, 89
05693	1608293	78, 89
05694	02.5070.87.00	78, 89
05694	-	78, 89
05694	659 112 613	78, 89
05717	05.260.14.05.0	68
05717	-	68
05719	03.143.00.02.0	73
05719	-	73
05745	3 302 1045 00	88
05746	1 303 1045 11	39, 88
05750	3 302 1040 00	88
05751	1 303 1040 11	39, 88
05778	1573082	38, 84
05779	1573081	37, 84
05901	03.310.10.13.0	71, 84
05901	-	71, 84
05901	0701 104 07	71, 84
05915	0 272 853	37
05916	1 368 690	36
05917	0 295 953	36, 85
06218	6 119 808	11
06218	84VB1121AA	11
06218	-	11, 60
06254	02.5270.73.00	58
06254	-	58
06270	309 401 02 71 S1	81
06271	309 402 02 71 S1	81
06272	314 402 00 71 S2	81
06273	314 402 00 71 S3	81
06274	318 402 00 71 S2	81
06275	318 402 02 71 S2	81
06277	352 402 01 71 S1	81
06278	352 402 00 71 S2	81
06279	327 402 02 71 S2	81
06280	327 402 03 71 S2	81
06281	338 401 50 71 S1	81
06287	389 401 00 71 S3	84
06287	81.45501.0076 S2	84

Ref. - No.

06289	381 401 03 71 S1	82, 83
06289	81.45501.0137 S2	82, 83
06291	381 401 05 71 S3	83
06291	-	83
06292	381 401 06 71 S3	82
06292	-	82
06293	381 401 07 71 S3	82
06293	-	82
06294	381 401 08 71 S2	83
06297	304 402 02 71 S1	88
06425	03.260.04.10.0	67, 88
06425	-	67, 88
06425	4 342 0019 10	67, 88
06465	3 302 1078 00	81
06566	-	61
06963	3A0 601 139	2
07176	-	48
07300	09.806.23.29.0	88
07301	05.260.54.19.0	46, 88
07301	2 247 3021 00	46, 88
07301	-	46, 88
07304	A-JB-11623 A	26, 85
07304	650 2799 J	26, 85
07312	A-JA-0491-002	20, 85
07312	650 2798 G	20, 85
07400	06.11222.6309	54
07400	-	54
07428	81.45503.0025	54
07428	-	54
07456	09.80.623.4.10	88
07456	-	88
07635	03.112.00.42.0	74
07635	-	74
07636	03.112.00.43.0	74
07636	8.900.020.164	74
07663	05.260.54.10.0	44, 81, 84, 86, 87
07663	000 401 06 72	44, 81, 84, 86, 87
07663	0 4129 9921	44, 81, 84, 86, 87
07663	81.45503.0056	44, 81, 84, 86, 87
07663	-	44, 81, 84, 86, 87
07663	4 247 3012 01	44, 81, 84, 86, 87
07733	09.806.23.37.0	88
07733	-	88

Ref. - No.

07937	338 401 50 71 S2	81
07938	389 401 00 71 S4	84
07938	-	84
07939	389 401 00 71 S5	84
07939	-	84
07940	381 401 12 71 S1	23
07942	381 401 03 71 S2	83
07943	381 401 03 71 S3	83
07944	389 401 01 71 S1	26, 85
07945	381 401 05 71 S5	83
07945	-	83
07946	381 401 05 71 S4	83
07946	-	83
07947	381 401 06 71 S5	82
07947	-	82
07948	381 401 06 71 S4	82
07948	-	82
07949	381 401 07 71 S5	82
07949	-	82
07950	381 401 07 71 S4	82
07950	-	82
07951	381 401 08 71 S3	83
07953	381 401 13 71 S1	34
07955	304 402 02 71 S2	88
07967	-	49
07974	0 4103 2669	49
07974	-	49
08047	02.5270.72.00	59, 88
08047	-	59, 88
08048	02.5270.77.10	59
08048	601 3000 G	59
08048	-	59
08178	02.5202.32.80	68
08178	-	68
08178	06.11064.0222	68
08178	4 342 0011 80	68
08237	601 401 02 70	4
08237	2D0 601 139	4
08310	02.5450.22.00	89
08310	-	89
08310	000125 021000	89
08310	0 290 405	89
08310	659 120 228	89



Ref. - No.

Truck
Division 

Ref. - No.



Ref. - No.



08442	1309 191	24, 85
08443	1308 038	30, 85
08547	02.5070.89.00	77, 89
08547	-	77, 89
08547	620 401 00 70	77, 89
08547	0 338 883	77, 89
08547	659 112 616	77, 89
08547	1588406	77, 89
08548	02.5070.89.00 kpl.	89
08548	-	89
08548	620 401 00 70 kpl.	89
08548	0 338 883 S1	89
08548	659 112 616 S1	89
08548	1588406 S1	89
08824	09.806.23.41.0	88
09298	674 402 01 71	14
09801	WHT 002 437	3
09805	638 401 02 71	2
09806	05104018AA	6
09806	638 401 01 71	6
10444	00 00 190 220	28
10445	50 10 319 141	21
11616	5405.55	1
11938	40224-21001	7
11938	454 402 00 72	7
11939	5405.81	8
11939	90942-01007	8
11939	52951-11210	8
11939	0603-26-161A	8
11939	MR297927	8
11939	454 402 00 72	8
11939	30873148	8
12283	1355 553	66
12414	-	46
12414	1626659	46
12706	5405.30	3
12706	13229724	3
12707	5405.48	4
12707	1476244080	4
12862	314 402 00 71	13, 85
12862	314 402 00 71	85
12863	318 402 00 71	14, 85
12865	352 402 00 71	16, 85

12866	327 402 02 71	16, 85
12867	327 402 03 71	17, 85
12868	389 401 00 71 S2	23, 85
12868	81.45501.0133	23, 85
12869	381 401 12 71 S2	24, 85
12870	389 401 01 71	26, 85
12871	381 401 05 71	29, 85, 86
12871	81.45501.0139	29, 85, 86
12872	381 401 06 71 S2	30, 86
12872	-	30, 86
12873	381 401 07 71 S2	32, 86
12873	81.45501.0141	32, 86
12874	381 401 08 71	33, 86
12874	-	33, 86
12875	381 401 13 71	35
14039	356 401 00 71	19
14041	305 401 00 71	21, 86
14041	81.45501.0134	21, 86
14853	1 368 693	35, 86
14959	1 749 034	47, 82, 85, 86
14959	-	47, 82, 85, 86
14963	02.5070.86.00	77, 89
14963	0272 740	77, 89
14963	0 288 799	77, 89
14963	659 112 611	77, 89
14963	-	77, 89
15144	RAK 5904	45, 86, 87
15170	81.45501.0129	18
15341	0 4253 4370	27
15341	N1.01101.3141	27
15686	02.5070.86.00 kpl.	89
15686	0272 740 S1	89
15686	659 112 611 S1	89
15686	-	89
15760	1356 736	28, 86
17818	1 126 877	6
17818	YM211K013AB	6
17818	7M3 601 139 B	6
18693	81.45501.0076 S3	23
18693	0801.116.26 S	23
18694	81.45501.0081 S	31
18694	0821.210.19 S	31
18825	50 10 439 317	29, 86

Ref. - No.

18826	50 00 351 162	17
18913	000 990 49 07	3
19331	6.125.312.233	18, 86
21175	5405.66	1
21175	9682405480	1
21583	976 401 02 71	17
21588	WHT 002 529	6
22474	05104651AA	9
22474	074361 014205	9, 54
22474	074361 014205	9
22474	-	9, 54
22600	-	65
22777	05.260.54.10.0	45
22777	4 247 3012 01	45
22790	-	66
22791	-	65
23756	-	42
24241	50 10 457 733	44
24241	-	44
24335	-	50, 86, 87
24335	20552688	50, 86, 87
24397	20707705	28
24626	74 21 303 956	44, 86, 87
24626	-	44, 86, 87
24626	21303956	44, 86, 87
24645	05104080AA	5
24645	901 401 00 70	5
24774	659 112 614	78, 89
24774	-	78, 89
24775	659 112 614 S1	89
24775	-	89
24779	50 10 439 406	35
26747	93858987	5
26747	40254-00QAF	5
26747	4418 227	5
26747	82 00 639 129	5
26828	81.45503.0062	42
26828	000 990 50 53	42
26828	50 10 262 936	42
26828	-	42
27413	1 470 843	7
27413	W713392S440	7
27413	9XG0-03-44X9-AA	7

Ref. - No.

27413	999359	7
27544	942 401 02 71 S1	84
27545	942 401 03 71 S1	84
27796	50 00 737 601	20
28097	000 401 13 72	50, 87
28097	0 4103 2670	50, 87
28097	-	50, 87
29208	5405.67	1
29208	9644576680	1
29418	948 401 02 71	25
29463	-	48
29466	68006805AA	4
29466	000 990 24 07	4
29466	WHT 000 888	4
29942	381 401 06 71	30, 86
29942	3.814.010.671	30, 86
29943	381 401 07 71	32, 86
30400	16 087 344 80	1
30400	9634648980	1
32043	970 401 00 71	12
32439	5405.68	4
32439	1493974080	4
32440	5405.75	3
32440	1345713080	3
32441	5405.78	5
32441	1363349080	5
32442	5405.79	7
32442	1351203080	7
32450	5405.76	6
32450	1345714080	6
32796	74 20 515 514	22
32796	20515514	22
32797	74 20 515 515	25
32797	20515515	25
32798	74 20 515 517	28
32798	20515517	28
32799	74 20 515 519	31
32799	20515519	31
32800	74 20 553 560	34
32800	20553560	34
32801	74 21 147 687	33, 86
32801	21147687	33, 86
34334	5 0429 4388	43



Ferdinand Bilstein GmbH + Co. KG
Wilhelmstr. 47 | 58256 Ennepetal | Germany
Tel. +49 2333 911-0
Fax +49 2333 911-444
E-Mail info@febi.com
febi is a bilstein group brand

www.febi.com

