



Air-Itens, S.L.

NUESTRO OBJETIVO ES COLABORAR EN LA PROSPERIDAD DE SU EMPRESA OFRECIÉNDOLES LA CALIDAD DE NUESTROS PRODUCTOS Y NUESTRO MEJOR SERVICIO.

AIR-FREN

MARCA REGISTRADA EN EL BOLETÍN OFICIAL MARCAS COMUNITARIAS; N° EXP. I/COMUNIT/2621332

OUR OBJECTIVE IS TO COLLABORATE ON THE SUCCESS OF YOUR COMPANY OFFERING YOU THE QUALITY OF OUR PRODUCTS AND OUR BEST SERVICE.

AIR-FREN

MARK REGISTERED BY COMMUNITY TRADE MARKS OFICIAL BULLETIN; N° EXP. I/COMUNIT/2621332

A Nuestros Clientes

Todas las referencias incluidas en este catálogo son sólo para realizar cruces comparativos, no serán usadas en facturas comerciales.

Todas las referencias de vehículos y fabricantes son sólo de uso informativo.

Constantemente estamos introduciendo referencias nuevas, por lo que si tiene necesidad de alguna pieza que no figura en el catálogo, no dude en ponerse en contacto con nosotros.



To Our Customers

The reference numbers included in this catalogue are only for comparison purposes, should not be used in commercial invoices.

Vehicle and item reference numbers in this catalogue are given only for information.

We are constantly introducing new reference numbers, so if you need some items which do not appear in the catalogue, do not hesitate to contact us.





Air-Tren,SI

| | | |
|-----|--|-----|
| 01. | Compresores | 7 |
| | Air compressors | |
| 02. | Cilindros, actuadores y cámaras de freno | 63 |
| | Cylinders, actuators and brake chambers | |
| 03. | Válvulas de pedal | 77 |
| | Foot valves | |
| 04. | Válvulas freno de mano | 87 |
| | Hand brake valves | |
| 05. | Válvulas relé | 99 |
| | Relay valves | |
| 06. | Válvulas protección circuito | 113 |
| | Circuit protection valves | |
| 07. | Reguladores de presión | 119 |
| | Unloader valves | |
| 08. | Válvulas niveladoras | 127 |
| | Level valves | |
| 09. | Servoembragues | 139 |
| | Clutch servo units | |
| 10. | Otras válvulas | 159 |
| | Other valves | |
| 11. | Sólo kits de reparación | 199 |
| | Only repair kits | |
| 12. | Bombas de agua..... | 213 |
| | Water pumps | |
| 13. | Palancas automáticas de freno | 259 |
| | Automatic slack adjusters | |
| 14. | Otros productos | 279 |
| | Other products | |
| 15. | Conexiones eléctricas | 291 |
| | Electrical coils | |
| 16. | Retenes | 301 |
| | Seals | |
| 17. | Rodamientos de embrague | 307 |
| | Clutch bearings | |
| 18. | Kits reparación Caliper | 319 |
| | Caliper repair kits | |
| 19. | Cruce de referencias | 327 |
| | Cross reference list | |

01

COMPRESORES

AIR COMPRESSORS



| REF. AIR-FREN | REF. TACA |
|---------------|-----------|
| 01.1100.20 | 230.100.2 |
| 01.1100.90 | 230.100.9 |
| * 01.1100.50 | 230.100.5 |

* GIRO CARTER 180 °
RVI, EBRO, NISSAN



| REF. AIR-FREN | REF. TACA |
|---------------|-----------|
| 01.1100.60 | 230.100.6 |

RVI



| REF. AIR-FREN | REF. TACA |
|---------------|-----------|
| 01.1500.10 | 230.150.0 |

EBRO, NISSAN



| REF. AIR-FREN | REF. TACA |
|---------------|-----------|
| 01.2320.40 | 230.200.4 |

RVI

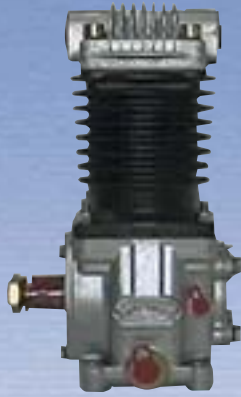

| REF. AIR-FREN | REF. TACA |
|---------------|-----------|
| 01.2320.80 | 230.200.8 |

RVI

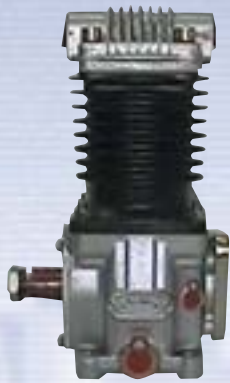

| REF. AIR-FREN | REF. TACA |
|---------------|-----------|
| 01.2320.90 | 230.200.9 |

RVI



| REF. AIR-FREN | REF. TACA |
|---------------|-----------|
| 01.1150.00 | 230.300.0 |

RVI

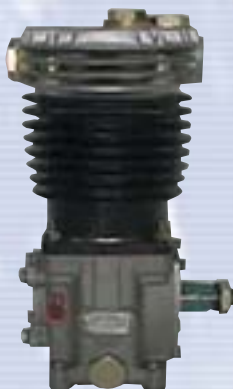

| REF. AIR-FREN | REF. TACA |
|---------------|-----------|
| 01.1150.20 | 230.300.2 |

RVI



| REF. AIR-FREN | REF. TACA |
|---------------|-----------|
| 01.1150.60 | 230.300.6 |

RVI

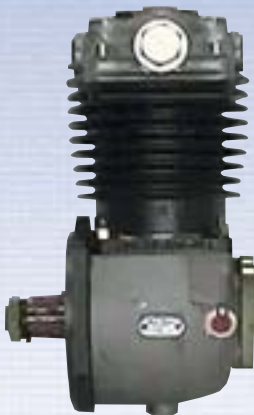

| REF. AIR-FREN | REF. TACA |
|---------------|-----------|
| 01.1150.90 | 230.300.9 |

RVI



| REF. AIR-FREN | REF. TACA |
|-----------------|-----------|
| * 01.230.301.6 | 230.301.6 |
| 01.230.301.7 | 230.301.7 |
| ** 01.230.301.8 | 230.301.8 |

* SIN ROMBO LATERAL

** CULATA DE AIRE ROSCADA, M26x1.5

RVI

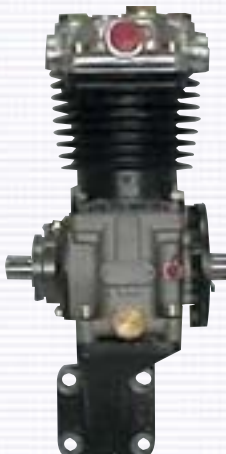

| REF. AIR-FREN | REF. TACA |
|---------------|-----------|
| 01.230.303.0 | 230.303.0 |

EBRO, NISSAN



| REF. AIR-FREN | REF. TACA |
|---------------|-----------|
| 01.3005.00 | 230.305.0 |

RVI



| REF. AIR-FREN | REF. TACA |
|---------------|-----------|
| 01.3005.20 | 230.305.2 |

RVI



| REF. AIR-FREN | REF. TACA |
|---------------|-----------|
| 01.3701.10 | 230.370.1 |
| 01.3701.20 | 230.370.2 |
| 01.3701.30 | 230.370.3 |
| 01.3701.40 | 230.370.4 |
| 01.3701.50 | 230.370.5 |
| 01.3701.60 | 230.370.6 |
| 01.3701.90 | 230.370.9 |

IVECO, PEGASO



Compresor Pegaso Troner 360, 370 / Air Compressor

| REF. AIR-FREN | REF. WABCO | REF. PEGASO |
|---------------|-------------------------------------|-------------------------------|
| 01.774.951 | 461.182.2 461.343.9 461.343.1 | 774.951 774.092 773.136 |

conicidad: 20-25



Compresor Pegaso Tecno y Troner 340 / Air Compressor

| REF. AIR-FREN | REF. WABCO | REF. PEGASO |
|---------------|------------|--------------------|
| 01.772.590 | 460.896.5 | 772.590 771.076 |

Intercambiable con 110.038 Bendix
conicidad: 25-30



Placas de compresor / Compressor plates

| REF. AIR-FREN | REF. WABCO |
|---------------|------------|
| 01.391.300 | 403.258.2 |

ø 75 mm.

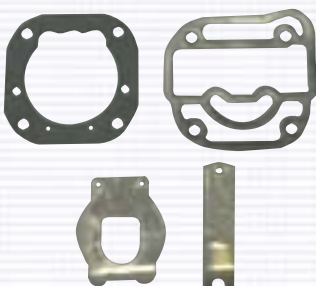

Kit laminillas / Lamelles kit

| ø 75 | REF. AIR-FREN |
|-------|---------------|
| WABCO | 01.R391.103 |

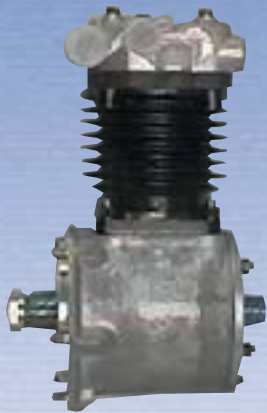

| REF. AIR-FREN | REF. WABCO | REF. PEGASO |
|---------------|------------|-------------|
| 01.772.938 | 461.140.2 | 772.938 |
| 01.772.950 | 461.142.0 | 772.950 |
| 01.772.951 | 461.144.8 | 772.951 |
| 01.772.952 | 461.146.6 | 772.952 |
| 01.772.956 | 461.148.4 | 772.956 |

IVECO, PEGASO



| REF. AIR-FREN | REF. WABCO | REF. PEGASO |
|---------------|------------|-------------|
| 01.568.840 | 461.133.6 | 568.840 |

IVECO, PEGASO



Conjunto Matacas Culata-Cilindro

| REF. AIR-FREN | REF. WABCO | REF. PEGASO |
|---------------|------------|-------------|
| 01.1300.30 | 403.731.8 | 177.979 |

IVECO, PEGASO



Pistón / Piston

| REF. AIR-FREN | REF. WABCO |
|---------------|------------|
| 01.523.060 | 402.726.9 |

IVECO, PEGASO



| REF. AIR-FREN | REF. TACA |
|---------------|-----------|
| 01.1024.40 | 231.102.4 |
| 01.1024.50 | 231.106.5 |
| 01.1024.70 | 231.106.7 |
| 01.1024.80 | 231.106.8 |
| 01.1024.90 | 231.106.9 |

RVI



| REF. AIR-FREN | REF. TACA |
|---------------|-----------|
| 01.1024.20 | 231.101.2 |

RVI



| REF. AIR-FREN | REF. WABCO |
|---------------|---------------|
| 01.1070.00 | 411.522.718.0 |

Culata Agua / Water Head Compressor



| REF. AIR-FREN | REF. WABCO |
|---------------|---------------|
| 01.1080.00 | 411.522.717.0 |

Culata Aire / Air Head Compressor



| REF. AIR-FREN | REF. MERCEDES |
|---------------|---------------|
| 01.1200.10 | 001.131.94.01 |



Mercedes-Benz

MERCEDES



| REF. AIR-FREN | REF. IVECO-MAGIRUS |
|---------------|--------------------|
| 01.1200.25 | 11737520 |

IVECO

IVECO, MAGIRUS

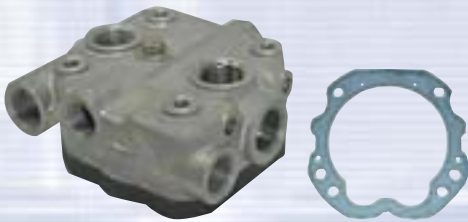

Culata de compresor / Head compressor

| REF. AIR-FREN | REF. WABCO | |
|---------------|---------------|------------|
| 01.1300.10 | 411.033.806.2 | AGUA/WATER |



Placa compresor
Plate Head Compressor

| REF. AIR-FREN | REF. WABCO |
|---------------|---------------|
| 01.391.400 | 411.033.503.2 |



Kit laminillas / Lamelles kit

| Ø 90 | REF. AIR-FREN |
|-----------------------------------|---------------|
| WABCO KNORR-BREMSE AIR-FREN | 01.R391.100 |





| REF. AIR-FREN | REF. MERCEDES |
|---------------|---------------|
| 01.1200.15 | 001.131.52.01 |



Mercedes-Benz

MERCEDES



| REF. AIR-FREN | REF. IVECO-MAGIRUS |
|---------------|--------------------|
| 01.1200.20 | 1173860 |

IVECO

IVECO, MAGIRUS

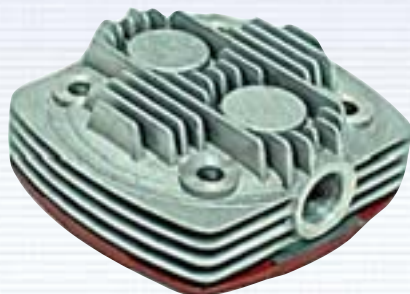

Culata de Aire / Air head compressor

| REF. AIR-FREN | |
|---------------|------------|
| 01.1300.15 | AIRE / AIR |



Placa compresor / Plate Head Compressor

| REF. AIR-FREN | REF. MERCEDES | PARA / FOR COMPRESSOR |
|---------------|---------------|-----------------------|
| 01.391.150 | 000 130 13 20 | 411.034.501.0 |

MERCEDES

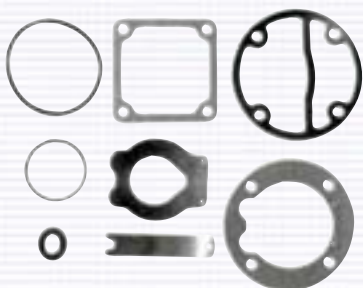

| REF. AIR-FREN | PARA / FOR COMPRESSOR |
|---------------|-----------------------|
| 01.R391.101 | 411.034.501.0 |

MERCEDES

DAF



Compresor bicilíndrico / Air compressor

| REF. AIR-FREN | REF. WABCO | REF. DAF |
|---------------|--------------------------------|----------|
| 01.1200.30 | 911.501.015.0 911.501.010.0 | 285596 |



Culata de aire / Air head compressor

| REF. AIR-FREN | REF. WABCO | REF. DAF |
|---------------|---------------|----------|
| 01.1300.25 | 911.501.800.2 | 692001 |

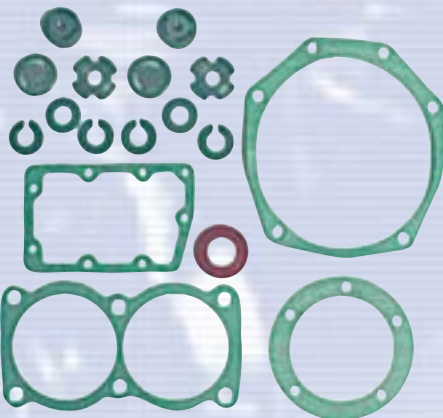

Kit reparación / Repair kit
 Para / for DAF 911.501.015.0

REF. AIR-FREN

01.R391.112



Compresor bicilíndrico / Air compressor

| REF. AIR-FREN | REF. WABCO | REF. DAF |
|---------------|--------------------------------|----------------------------|
| 01.1200.35 | 911.501.016.0 911.501.011.0 | 285597 644264 667441 |



Culata de aire / Air head compressor

| REF. AIR-FREN | REF. WABCO | REF. DAF |
|---------------|---------------|----------|
| 01.1300.35 | 911.501.801.2 | 692002 |

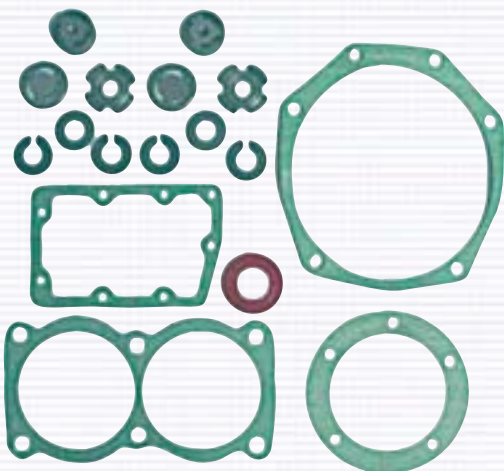

Kit reparación / Repair kit
Para / for DAF 911.501.016.0

REF. AIR-FREN

01.R391.112

DAF



Compresor bicilíndrico / Air compressor

| REF. AIR-FREN | REF. WABCO | REF. DAF |
|---------------|---|------------------|
| 01.1200.40 | 911.505.050.0 911.501.050.0 911.501.060.0 | 537745 555097 |



Culata de agua / Water head compressor

| REF. AIR-FREN | REF. WABCO | REF. DAF |
|---------------|---------------|----------|
| 01.1300.40 | 911.505.800.2 | 066043 |

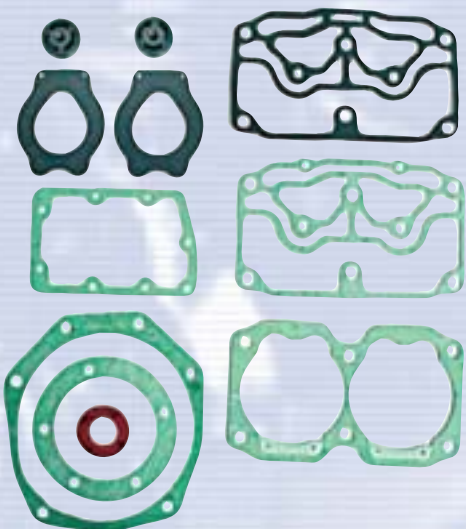

Kit reparación / Repair kit
 Para / for DAF 911.501.050.0

REF. AIR-FREN

01.R391.113



Compresor bicilíndrico / Air compressor

| REF. AIR-FREN | REF. WABCO | REF. DAF |
|---------------|--------------------------------|------------------|
| 01.1200.45 | 911.501.051.0 911.501.061.0 | 537746 555098 |



Culata de agua / Water head compressor

| REF. AIR-FREN | REF. WABCO | REF. DAF |
|---------------|---------------|----------|
| 01.1300.40 | 911.505.800.2 | 066043 |

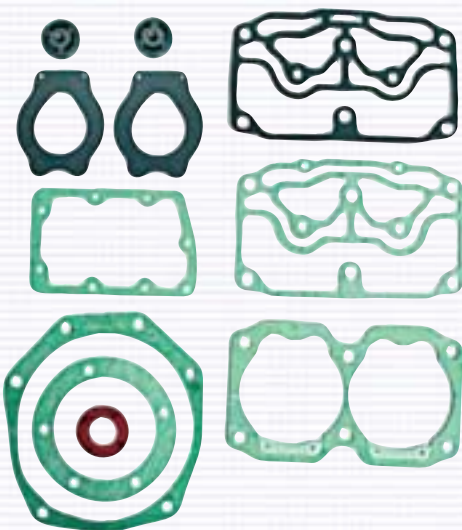

Kit reparación / Repair kit
Para / for DAF 911.501.051.0

REF. AIR-FREN

01.R391.113

DAF



Compresor bicilíndrico / Air compressor

| REF. AIR-FREN | REF. WABCO | REF. DAF |
|---------------|---------------|----------|
| 01.1200.50 | 911.504.051.0 | 762788 |
| | 911.504.052.0 | 528737 |

DAF 95 380



Culata de agua / Water head compressor

| REF. AIR-FREN | REF. WABCO | REF. DAF |
|---------------|---------------------------|----------|
| 01.1300.115 | 911.504.650.2 complete | - |

DAF 95 380



Placa compresor / Plate Head Compressor
Para / for DAF 95 380

| REF. AIR-FREN | REF. WABCO | REF. DAF |
|---------------|---------------|----------|
| 01.391.800 | 911.504.500.2 | 513823 |

DAF

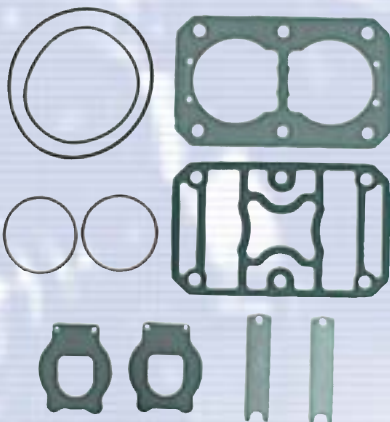

Kit reparación / Repair kit
Para / for DAF 95 380

| REF. AIR-FREN | PARA / FOR COMPRESSOR |
|---------------|-----------------------|
| 01.R391.114 | 911.504.051.0 |
| | 911.504.052.0 |

DAF



Compresor bicilíndrico / Air compressor

| REF. AIR-FREN | REF. WABCO | REF. DAF |
|---------------|---------------|----------|
| 01.1200.55 | 911.504.056.0 | 1243571 |

DAF 95 400



Culata de agua / Water head compressor

| REF. AIR-FREN | REF. DAF |
|---------------|----------|
| 01.1300.85 | 1253530 |

DAF 95 400

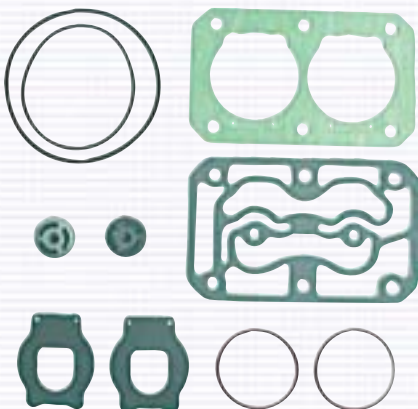

Kit reparación / Repair kit
Para / for DAF 95 400

| REF. AIR-FREN | PARA / FOR COMPRESSOR |
|---------------|-----------------------|
| 01.R391.115 | 911.504.056.0 |
| | 911.504.059.0 |
| | 911.504.060.0 |

DAF

DAF



Compresor bicilíndrico / Air compressor

| REF. AIR-FREN | REF. KNORR | REF. DAF |
|---------------|---------------------|----------|
| 01.1200.85 | LP-4823 SEB01782 | 1241874 |



Culata de agua vacía / Head compressor (only aluminium body)

| REF. AIR-FREN | REF. KNORR | REF. DAF |
|---------------|------------|----------|
| 01.1300.110 | SEB01093 | 1283815 |

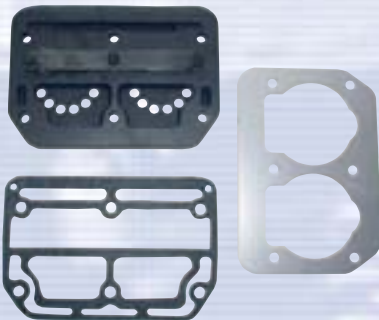

Placa de compresor / Plate head compresor

| REF. AIR-FREN | REF. KNORR | REF. DAF |
|---------------|------------|----------|
| 01.391.1200 | SEB01000 | 1283817 |

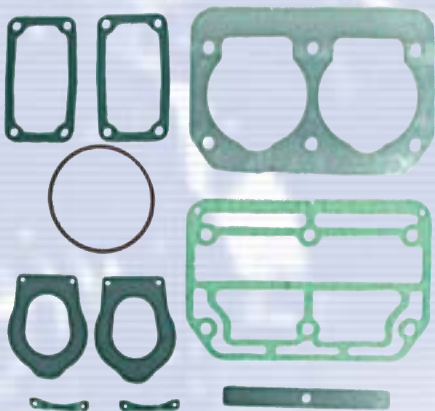

Kit reparación / Repair kit Para / for LP 4823

REF. AIR-FREN

01.R391.116



Compresor bicilíndrico / Air compressor

| REF. AIR-FREN | REF. WABCO | REF. DAF |
|---------------|--------------------------------|--------------------|
| 01.1200.130 | 911.504.060.0 911.504.059.0 | 1298052 1274407 |



Culata de agua / Water head compressor

| REF. AIR-FREN | REF. WABCO | REF. DAF |
|---------------|---------------|----------|
| 01.1300.100 | 911.503.805.2 | 1253530 |

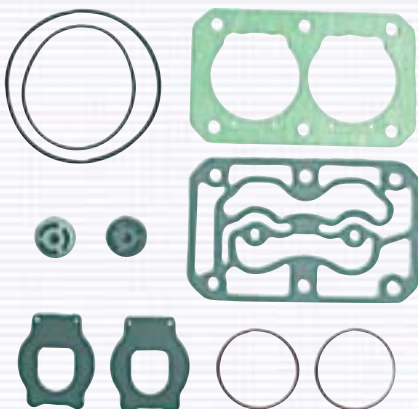

Kit reparación / Repair kit
Para / for DAF 95 400

| REF. AIR-FREN | PARA / FOR COMPRESSOR |
|---------------|---|
| 01.R391.115 | 911.504.056.0 911.504.059.0 911.504.060.0 |

DAF

DAF



Compresor bicilíndrico DAF XF95 / XF95 Air compressor

| REF. AIR-FREN | REF. WABCO | REF. DAF |
|---------------|---------------|----------|
| 01.1200.170 | 911.504.501.0 | 1310523 |



Culata de agua compresor / Water head compressor

| REF. AIR-FREN | REF. WABCO |
|---------------|---------------|
| 01.1300.125 | 911.504.920.2 |

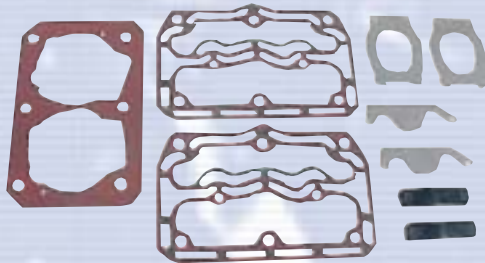

Kit reparación / Repair kit

| REF. AIR-FREN |
|---------------|
| 01.R391.125 |

IVECO



Compresor monocilíndrico Iveco / Air compressor

| REF. AIR-FREN | REF. KNORR | REF. IVECO |
|---------------|--------------------|------------|
| 01.1200.135 | LK-1900 LP-1974 | 1173859 |



Culata de aire / Air head compressor

REF. AIR-FREN

01.1300.105

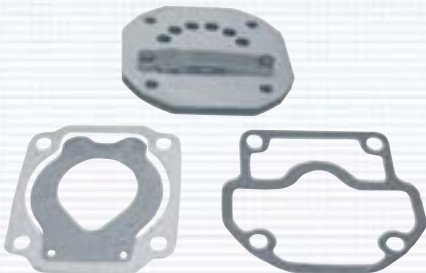

Placa de compresor / Plate head compressor

REF. AIR-FREN

01.391.1150

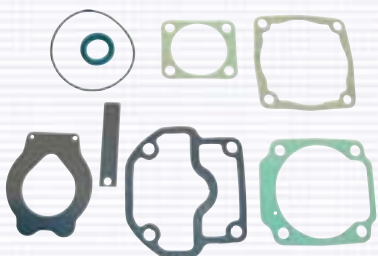

Kit reparación / Repair kit

REF. AIR-FREN

01.R391.138

IVECO



Compresor bicilíndrico Iveco / Air compressor

| REF. AIR-FREN | REF. KNORR | REF. IVECO |
|---------------|------------|------------|
| 01.1200.160 | ACX-83D | 500310903 |



Culata de agua / Water head compressor

REF. AIR-FREN

01.1300.130

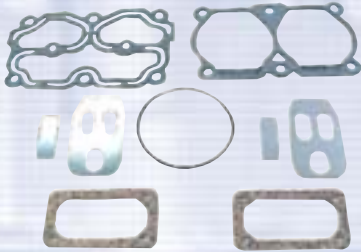

Kit juntas + válvulas Iveco / Repair kit

| REF. AIR-FREN | PARA / FOR COMPRESSOR |
|---------------|--|
| 01.R391.133 | ACX80AA; ACX82A ACX83A; ACX83AS ACX83B; ACX83D |

IVECO



Ø 82

REF. AIR-FREN

BENDIX
IVECO

01.R391.110

Compressor ACX 83D; ACX 83D-X; ACX 83-D-K



Compresor bicilíndrico Iveco cursor / Air compressor

| REF. AIR-FREN | REF. KNORR | REF. IVECO |
|---------------|------------|----------------------------------|
| 01.1200.105 | LP-4857 | 99471918 41211121 41211339 |



Compresor bicilindrico MAN / Air Compressor

| REF. AIR-FREN | REF. MAN |
|---------------|----------------|
| 01.1200.155 | 51 54000 70 79 |



Mercedes-Benz



Compresor MERCEDES OM405 / Air Compressor

| REF. AIR-FREN | REF. MERCEDES |
|---------------|---------------|
| 01.1200.190 | 447 130 05 15 |

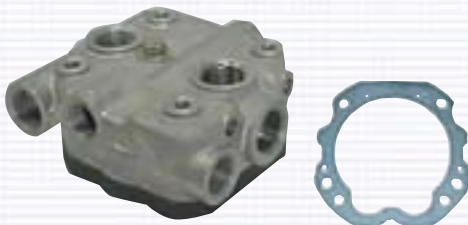

Culata de agua / Water head compressor

| REF. AIR-FREN | REF. WABCO |
|---------------|---------------|
| 01.1300.10 | 411.033.806.2 |



Mercedes-Benz



Compresor Mercedes Atego, Mercedes Axor / Air compressor

| REF. AIR-FREN | REF. WABCO | REF. MERCEDES |
|---------------|---------------|---------------|
| 01.1200.110 | 411.154.000.0 | 906 130 12 15 |

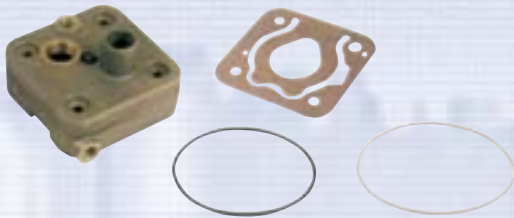

Culata de agua / Water head compressor

| REF. AIR-FREN | REF. WABCO |
|---------------|---------------|
| 01.1300.80 | 411.154.001.2 |

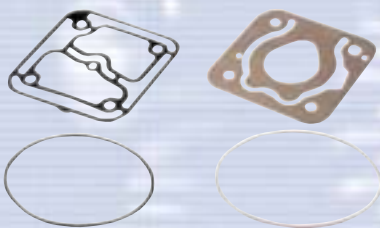

Kit reparación / Repair kit
 Para / for Mercedes Atego

| REF. AIR-FREN | REF. WABCO |
|---------------|---------------|
| 01.R391.136 | 411.151.923.2 |



Kit reparación / Repair kit
 Para / for Mercedes Atego

| REF. AIR-FREN | REF. WABCO |
|---------------|------------|
| 01.R391.137 | - |



Mercedes-Benz



Compresor monocilíndrico Mercedes / Air compressor

| REF. AIR-FREN | REF. KNORR | REF. MERCEDES |
|---------------|------------|---------------|
| 01.1200.175 | LK-1527 | 004 131 05 01 |

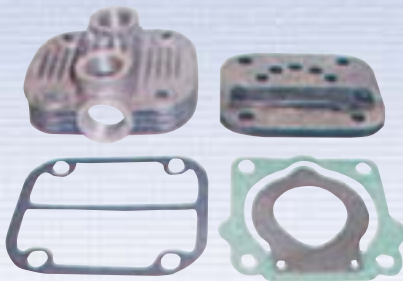

Culata de aire compresor / Air head compressor

| REF. AIR-FREN | REF. KNORR |
|---------------|------------|
| 01.1300.190 | - |

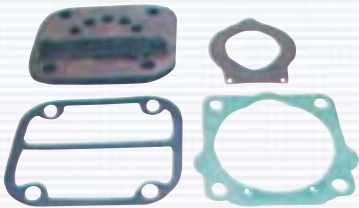

Placa de compresor / Plate head compressor

| REF. AIR-FREN | REF. KNORR |
|---------------|------------|
| 01.391.1350 | - |

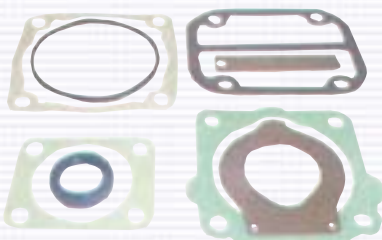

Kit reparación / Repair kit

| REF. AIR-FREN |
|---------------|
| 01.R391.149 |



Mercedes-Benz



Compresor monocilíndrico Mercedes / Air compressor

| REF. AIR-FREN | REF. WABCO | REF. MERCEDES |
|---------------|---------------|---------------|
| 01.1200.185 | 412.352.010.0 | 457 130 17 15 |
| | 412.352.014.0 | 457 130 24 14 |
| | 452.352.011.0 | 457 130 23 15 |
| | 452.352.015.0 | 457 130 16 15 |



Culata de agua compresor / Water head compressor

| REF. AIR-FREN | REF. WABCO |
|---------------|------------|
| 01.1300.155 | - |

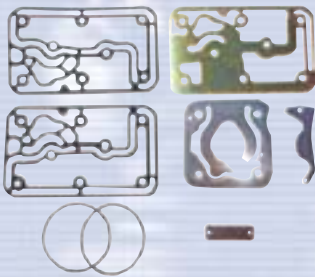

Placa de compresor / Plate head compressor

| REF. AIR-FREN | REF. WABCO |
|---------------|------------|
| 01.391.1400 | - |

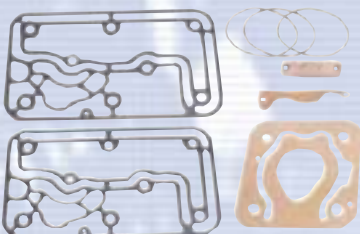

Kit reparación / Repair kit

| REF. AIR-FREN | REF. WABCO | REF. MERCEDES |
|---------------|---------------|---------------|
| 01.R391.143 | 412.352.923.2 | 001 130 26 15 |



Compresor bicilíndrico / Air compressor

| REF. AIR-FREN | REF. BENDIX | REF. VOLVO |
|---------------|-------------|--|
| 01.1200.60 | KZ 433/1/5 | 1080437 1612335 1590264 1570994 |



Culata de agua vacía / Water head compressor

| REF. AIR-FREN | REF. BENDIX | REF. VOLVO |
|---------------|-------------|-------------------------------|
| 01.1300.45 | KZ 416/1 | 1695153 3090472 1518374 |



**Placa de compresor / Plate head compressor
(Antigua versión) / (Old version)**

| REF. AIR-FREN | REF. BENDIX | REF. VOLVO |
|---------------|-------------|------------|
| 01.391.450 | KZ 426/11 | 1518372 |



**Placa de compresor / Plate head compressor
(Nueva versión) / (New version)**

| REF. AIR-FREN | REF. VOLVO |
|---------------|------------|
| 01.391.500 | 3090473 |

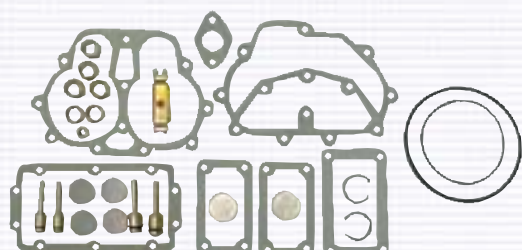

**Kit reparación compresor bicilíndrico
/ Repair kit two piston compressor**

| REF. AIR-FREN | REF. BENDIX | REF. WABCO |
|---------------|---------------|------------|
| 01.R110061 | SK-2681/1/2/4 | 404.596.2 |

SCANIA, VOLVO

VOLVO



Compresor bicilíndrico / Air compressor

| REF. AIR-FREN | REF. KNORR | REF. VOLVO |
|---------------|---------------------|------------|
| 01.1200.65 | LP-4825 II-15993 | 8150407 |

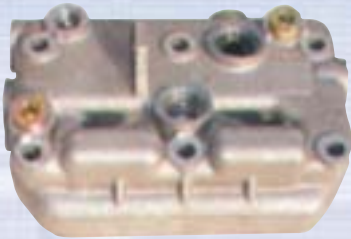

Culata de agua vacía / Water head compressor (Only aluminium body)

| REF. AIR-FREN | REF. VOLVO |
|---------------|------------|
| 01.1300.160 | 3090378 |



Placa de compresor / Plate head compressor

| REF. AIR-FREN | REF. VOLVO |
|---------------|------------|
| 01.391.600 | 3090380 |

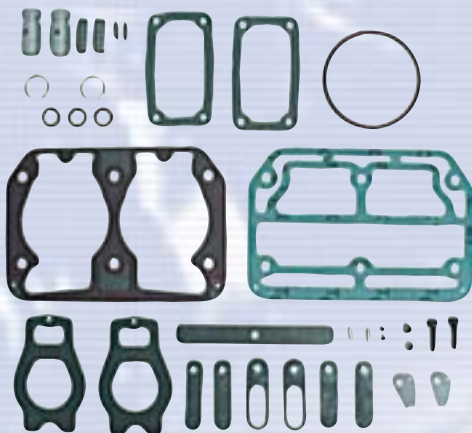

Kit reparación / Repair kit
 Para / for LP-4825

REF. AIR-FREN

01.R391.121

VOLVO



Compresor bicilíndrico / Air compressor

| REF. AIR-FREN | REF. WABCO | REF. VOLVO |
|---------------|--------------------------------|--------------------|
| 01.1200.70 | 911.505.150.0 911.505.151.0 | 1626060 5003460 |



Culata de agua / Water head compressor

| REF. AIR-FREN | REF. WABCO | REF. VOLVO |
|---------------|---------------|------------|
| 01.1300.50 | 911.505.801.2 | 1698680 |

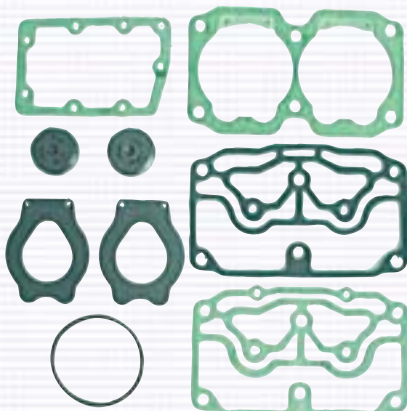

Kit reparación / Repair kit
Para / for 911.505.150.0

REF. AIR-FREN

01.R391.120

Para / for Wabco West. 704

VOLVO



Compresor bicilíndrico / Air compressor

| REF. AIR-FREN | REF. KNORR | REF. VOLVO |
|---------------|--------------------|------------|
| 01.1200.75 | LP-4812 I-86909 | 1599999 |



Culata de agua vacía / Water head compressor (Only aluminium)

| REF. AIR-FREN | REF. KNORR | REF. VOLVO |
|---------------|------------|------------|
| 01.1300.55 | SEB00421 | 1697771 |

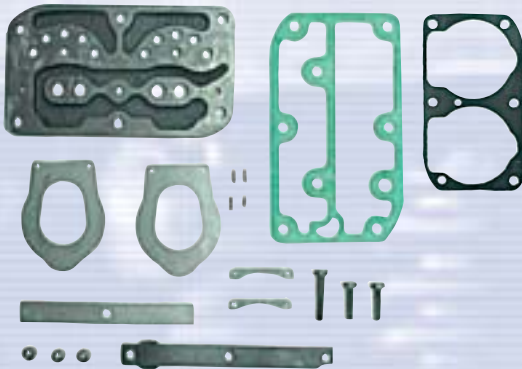

Placa compresor / Plate head compressor

| REF. AIR-FREN | REF. KNORR | REF. VOLVO |
|---------------|-------------|--------------------|
| 01.391.550 | I-81015/004 | 1697770 1697290 |

Para / for LP-4812; LP-4813; LP-4814; LP-4815

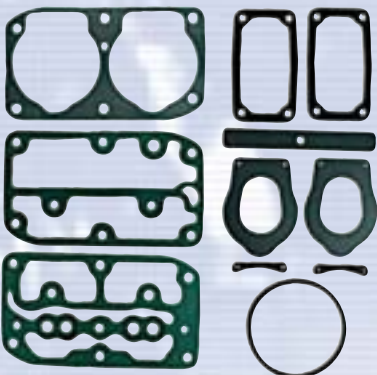

Kit reparación / Repair kit Para / for LP-4812

REF. AIR-FREN

01.R391.119

Para / for LP-4812; LP-4813; LP-4814; LP-4815

VOLVO



Compresor bicilíndrico / Air compressor

| REF. AIR-FREN | REF. KNORR | REF. VOLVO |
|---------------|--------------------|------------|
| 01.1200.80 | LP-4813 I-90499 | 1613632 |



**Culata de agua vacía /
Water head compressor (Only aluminium)**

| REF. AIR-FREN | REF. KNORR | REF. VOLVO |
|---------------|------------|------------|
| 01.1300.60 | SEB00551 | 1698156 |

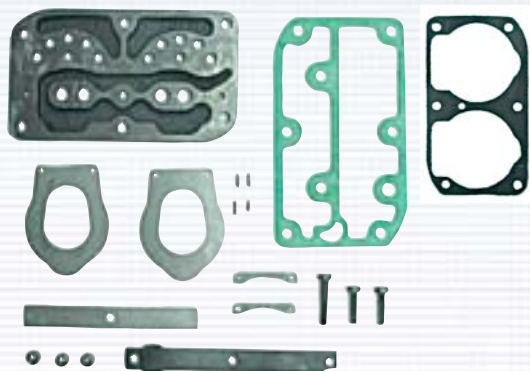

Placa compresor / Plate head compressor

| REF. AIR-FREN | REF. KNORR | REF. VOLVO |
|---------------|-------------|--------------------|
| 01.391.550 | I-81015/004 | 1697770 1697290 |

Para / for LP-4812; LP-4813; LP-4814; LP-4815

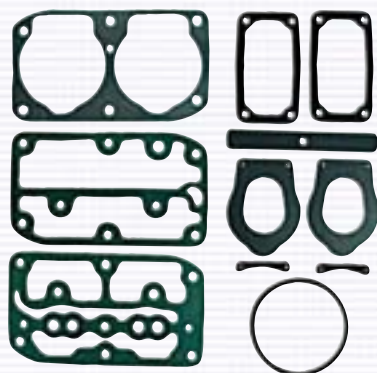

Kit reparación / Repair kit

| REF. AIR-FREN |
|---------------|
| 01.R391.119 |

Para / for LP-4812; LP-4813; LP-4814; LP-4815

VOLVO



Compresor bicilíndrico / Air compressor

| REF. AIR-FREN | REF. KNORR | REF. VOLVO |
|---------------|--------------------|------------|
| 01.1200.90 | LP-4974 LP-4930 | 1628593 |



Culata de agua vacía / Water head compressor (Only aluminium body)

| REF. AIR-FREN | REF. VOLVO |
|---------------|------------|
| 01.1300.165 | 1699820 |



Placa de compresor / Plate head compressor

| REF. AIR-FREN | REF. VOLVO |
|---------------|------------|
| 01.391.650 | 3097146 |

Para / for LP-4974; LP-4930; LP-4934; LP-4957; LP-4967; LP-4964



Kit reparación / Repair kit
Para / for LP-4974

| REF. AIR-FREN |
|---------------|
| 01.R391.122 |

Para / for LP-4974; LP-4930; LP-4934; LP-4957; LP-4967; LP-4964

VOLVO



Compresor bicilíndrico Volvo / Air compressor

| REF. AIR-FREN | REF. KNORR | REF. VOLVO |
|---------------|------------|------------|
| 01.1200.100 | LP-4967 | 8113023 |

VOLVO B10L,...

Culata de agua vacía / Water head compressor (Only aluminium body)



| REF. AIR-FREN | REF. VOLVO |
|---------------|------------|
| 01.1300.175 | - |

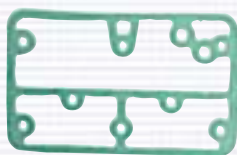
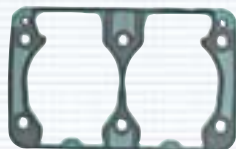

Placa de compresor / Plate head compressor

| REF. AIR-FREN | REF. VOLVO |
|---------------|------------|
| 01.391.650 | 3097146 |

Para / for LP-4974; LP-4930; LP-4934; LP-4957; LP-4967; LP-4964



Kit reparación / Repair kit
Para / for LP-4974

| REF. AIR-FREN |
|---------------|
| 01.R391.122 |

Para / for LP-4974; LP-4930; LP-4934; LP-4957; LP-4967; LP-4964

VOLVO



Compresor monocilíndrico Volvo / Air compressor

| REF. AIR-FREN | REF. KNORR | REF. VOLVO |
|---------------|------------|------------|
| 01.1200.195 | LP-4985 | 3173001 |



Culata de agua vacía / Water head compressor (Only aluminium body)

| REF. AIR-FREN | REF. VOLVO |
|---------------|------------|
| 01.1300.170 | - |



Placa de compresor / Plate head compressor

| REF. AIR-FREN | REF. VOLVO |
|---------------|------------|
| 01.391.1450 | - |

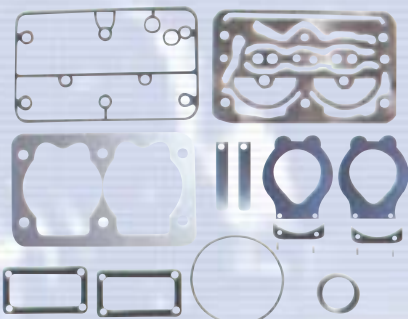

Kit reparación / Repair kit

| REF. AIR-FREN |
|---------------|
| 01.R391.150 |

VOLVO



Compresor bicilíndrico Volvo / Air compressor

| REF. AIR-FREN | REF. WABCO | REF. VOLVO |
|---------------|---|------------|
| 01.1200.180 | 412.704.008.0 412.704.005.0 412.704.004.0 | 20701801 |



Culata de agua compresor / Water head compressor

| REF. AIR-FREN | REF. WABCO | REF. VOLVO |
|---------------|---------------|------------|
| 01.1300.120 | 412.704.932.2 | 20701802 |

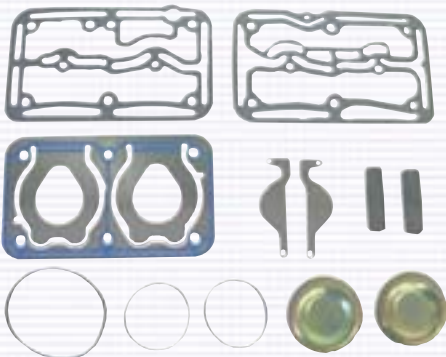

Kit reparación / Repair kit

| REF. AIR-FREN |
|---------------|
| 01.R391.140 |

SCANIA



Compresor bicilindrico Scania S-4 / Air compressor

| REF. AIR-FREN | REF. KNORR | REF. SCANIA |
|---------------|------------|-------------|
| 01.1200.95 | LP-4964 | 1380455 |



Culata de agua vacía / Water head compressor (Only aluminium body)

| REF. AIR-FREN | REF. SCANIA |
|---------------|-------------|
| 01.1300.135 | 1424766 |



Placa de compresor / Plate head compressor

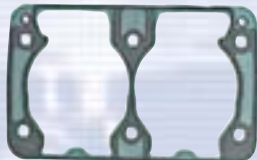

| REF. AIR-FREN | REF. VOLVO |
|---------------|------------|
| 01.391.650 | 3097146 |

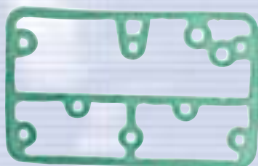

Para / for LP-4974; LP-4930; LP-4934; LP-4957; LP-4967; LP-4964; LP-4965



Kit reparación / Repair kit
 Para / for LP-4974

| REF. AIR-FREN |
|---------------|
| 01.R391.122 |

Para / for LP-4974; LP-4930; LP-4934; LP-4957; LP-4967; LP-4964; LP-4965

SCANIA



Compresor bicilindrico Scania S-4 / Air compressor

| REF. AIR-FREN | REF. KNORR | REF. SCANIA |
|---------------|------------|--------------------|
| 01.1200.165 | LP-4965 | 1380457 1379066 |



Culata de agua vacía / Water head compressor (Only aluminium body)

| REF. AIR-FREN | REF. SCANIA |
|---------------|-------------|
| 01.1300.135 | 1424766 |



Placa de compresor / Plate head compressor

| REF. AIR-FREN | REF. VOLVO |
|---------------|------------|
| 01.391.650 | 3097146 |

Para / for LP-4974; LP-4930; LP-4934; LP-4957; LP-4967; LP-4964; LP-4965

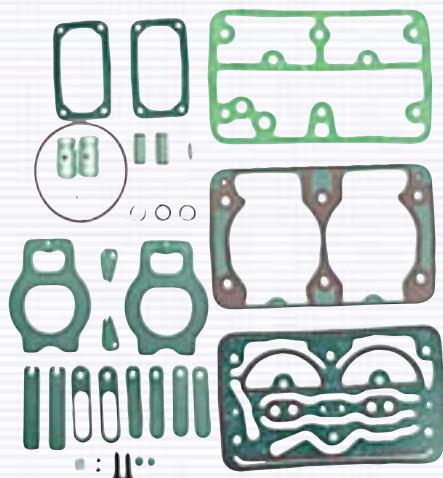
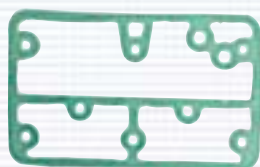

Kit reparación / Repair kit

Para / for LP-4974

REF. AIR-FREN

01.R391.122

Para / for LP-4974; LP-4930; LP-4934; LP-4957; LP-4967; LP-4964; LP-4965

SCANIA



Compresor bicilíndrico Scania / Air compressor

| REF. AIR-FREN | REF. KNORR | REF. SCANIA |
|---------------|------------|--------------------|
| 01.1200.210 | LP-4957 | 1349094 1380456 |



Culata de agua vacía / Water head compressor (Only aluminium body)

| REF. AIR-FREN | REF. VOLVO |
|---------------|------------|
| 01.1300.180 | 1376274 |



Placa de compresor / Plate head compressor

| REF. AIR-FREN | REF. VOLVO |
|---------------|------------|
| 01.391.650 | 3097146 |

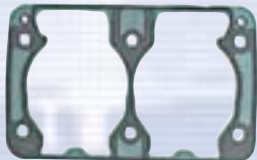

Para / for LP-4974; LP-4930; LP-4934; LP-4957; LP-4967; LP-4964

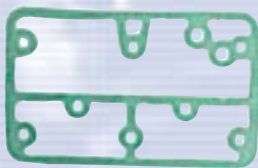

Kit reparación / Repair kit Para / for LP-4974

| REF. AIR-FREN |
|---------------|
| 01.R391.122 |

Para / for LP-4974; LP-4930; LP-4934; LP-4957; LP-4967; LP-4964



SCANIA



Compresor bicilíndrico / Air compressor

| REF. AIR-FREN | REF. KNORR | REF. SCANIA |
|---------------|------------|-------------|
| 01.1200.115 | LP-4814 | 1303226 |



Culata de agua vacía /
Water head compressor (Only aluminium body)

| REF. AIR-FREN | REF. KNORR |
|---------------|------------|
| 01.1300.75 | SEB22587 |

Para / for LP-4814; LP-4815; LP-4844

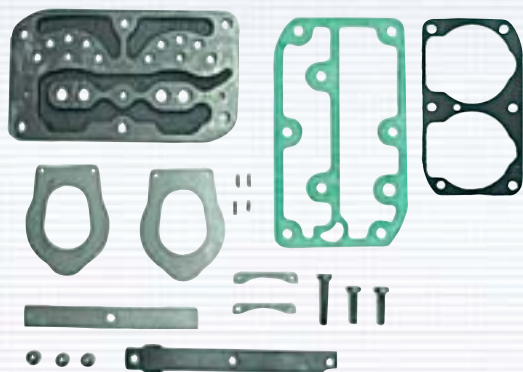

Placa compresor / Plate head compressor

| REF. AIR-FREN | REF. KNORR |
|---------------|-------------|
| 01.391.550 | I-81015/004 |

Para / for LP-4812; LP-4813; LP-4814; LP-4815



Kit reparación / Repair kit
Para / for LP-4812

| REF. AIR-FREN |
|---------------|
| 01.R391.119 |

Para / for LP-4812; LP-4813; LP-4814; LP-4815

SCANIA



| Compresor bicilíndrico / Air compressor | | |
|---|------------|-------------|
| REF. AIR-FREN | REF. KNORR | REF. SCANIA |
| 01.1200.120 | LP-4815 | 1303227 |



Culata de agua vacía /
Water head compressor (Only aluminium body)

| REF. AIR-FREN | REF. KNORR |
|---------------|------------|
| 01.1300.75 | SEB22587 |

Para / for LP-4814; LP-4815; LP-4844

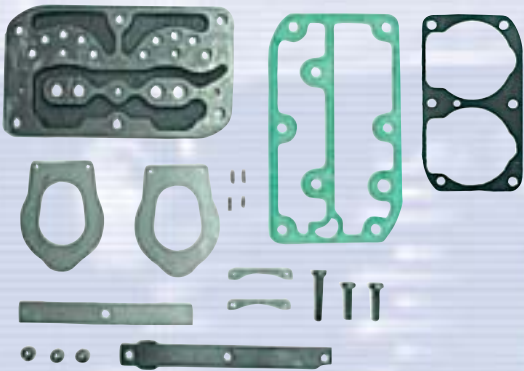

Placa compresor / Plate head compressor

| REF. AIR-FREN | REF. KNORR |
|---------------|-------------|
| 01.391.550 | I-81015/004 |

Para / for LP-4812; LP-4813; LP-4814; LP-4815



Kit reparación / Repair kit

| REF. AIR-FREN |
|---------------|
| 01.R391.119 |

Para / for LP-4812; LP-4813; LP-4814; LP-4815



Compresor bicilíndrico / Air compressor

| REF. AIR-FREN | REF. BENDIX | REF. SCANIA |
|---------------|-------------|-------------------|
| 01.1200.125 | KZ-642/2 | 1348919 300162 |



Culata de agua vacía / Water head compressor

| REF. AIR-FREN | REF. BENDIX | REF. SCANIA |
|---------------|-------------|-------------|
| 01.1300.90 | KZ-645/7 | 366810 |



Placa de compresor / Plate head compressor

| REF. AIR-FREN | REF. BENDIX | REF. SCANIA |
|---------------|-------------|-------------|
| 01.391.450 | KZ-426/2 | 1322813 |



Kit reparación compresor bicilíndrico / Repair kit

| REF. AIR-FREN | REF. BENDIX | REF. SCANIA |
|---------------|---------------|-------------|
| 01.R110061 | SK-2681/1/2/4 | 1327886 |

SCANIA



Compresor bicilíndrico / Air compressor

| REF. AIR-FREN | REF. BENDIX | REF. SCANIA |
|---------------|-------------|-------------------|
| 01.1200.140 | KZ-996/2 | 1314107 301525 |



Culata de agua vacía / Water head compressor

| REF. AIR-FREN | REF. BENDIX | REF. SCANIA |
|---------------|-------------|-------------|
| 01.1300.90 | KZ-645/7 | 366810 |



Placa de compresor / Plate head compressor

| REF. AIR-FREN | REF. BENDIX | REF. SCANIA |
|---------------|-------------|-------------|
| 01.391.450 | KZ-426/2 | 1322813 |



Kit reparación compresor bicilíndrico / Repair kit

| REF. AIR-FREN | REF. BENDIX | REF. SCANIA |
|---------------|---------------|-------------|
| 01.R110061 | SK-2681/1/2/4 | 1327886 |

SCANIA



Compresor bicilíndrico / Air compressor

| REF. AIR-FREN | REF. BENDIX | REF. SCANIA |
|---------------|-------------|-------------|
| 01.1200.145 | KZ-396/3 | 232615 |



Culata de agua vacía / Water head compressor

| REF. AIR-FREN | REF. BENDIX | REF. SCANIA |
|---------------|-------------|-------------|
| 01.1300.95 | | 1104991 |



Placa de compresor / Plate head compressor

| REF. AIR-FREN | REF. BENDIX | REF. SCANIA |
|---------------|-------------|-------------|
| 01.391.450 | KZ-426/2 | 1322813 |

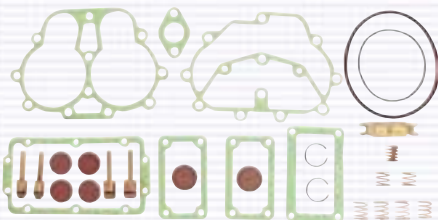

Kit reparación compresor bicilíndrico / Repair kit

| REF. AIR-FREN | REF. BENDIX | REF. SCANIA |
|---------------|---------------|-------------|
| 01.R110061 | SK-2681/1/2/4 | 1327886 |

SCANIA



Compresor bicilíndrico / Air compressor

| REF. AIR-FREN | REF. BENDIX | REF. SCANIA |
|---------------|-------------|-------------------|
| 01.1200.150 | KZ-1228/1 | 1300366 394441 |



Culata de agua vacía / Water head compressor

| REF. AIR-FREN | REF. BENDIX | REF. SCANIA |
|---------------|-------------|-------------|
| 01.1300.95 | - | 1104991 |



Placa de compresor / Plate head compressor

| REF. AIR-FREN | REF. BENDIX | REF. SCANIA |
|---------------|-------------|-------------|
| 01.391.450 | KZ-426/2 | 1322813 |



Kit reparación compresor bicilíndrico / Repair kit

| REF. AIR-FREN | REF. BENDIX | REF. SCANIA |
|---------------|---------------|-------------|
| 01.R110061 | SK-2681/1/2/4 | 1327886 |



Mercedes-Benz



Culata/90 Mercedes Actros / Head Compressor

| REF. AIR-FREN | REF. MERCEDES |
|---------------|---------------|
| 01.1300.65 | 442 130 07 20 |

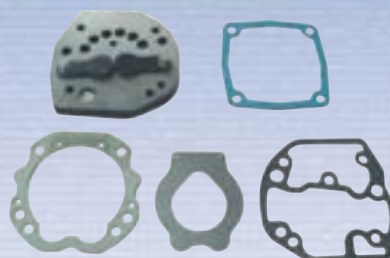

Placas compresor / Plate head compressor

| REF. AIR-FREN | REF. MERCEDES |
|---------------|---------------|
| 01.391.700 | 447 130 07 20 |

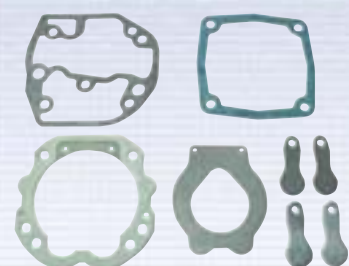

Kit reparación / Repair kit

| REF. AIR-FREN |
|---------------|
| 01.R391.123 |



Culata/100 Mercedes / Head Compressor

| REF. AIR-FREN | REF. MERCEDES |
|---------------|---------------|
| 01.1300.70 | 442 130 32 19 |



Placas compresor / Plate head compressor

| REF. AIR-FREN | REF. MERCEDES |
|---------------|---------------|
| 01.391.750 | 441 130 01 20 |



Kit reparación / Repair kit

| REF. AIR-FREN | REF. MERCEDES |
|---------------|---------------|
| 01.R391.124 | 441 130 02 20 |



Mercedes-Benz

Culata/100 Agua Mercedes Actros / Head compressor



REF. AIR-FREN

01.1300.140

REF. MERCEDES

541 131 11 19



REF. AIR-FREN

01.1300.145

REF. MERCEDES

541 131 10 19



Placas compresor / Plate head compressor

REF. AIR-FREN

01.391.1250

REF. MERCEDES

541 130 06 20

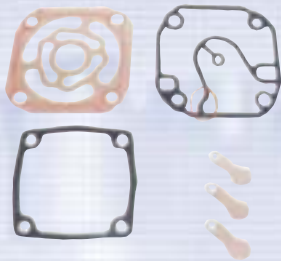

Kit reparación / Repair kit

REF. AIR-FREN

01.R391.141

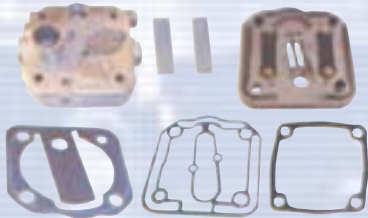

Culata/100 Agua Mercedes Actros / Head compressor

REF. AIR-FREN

01.1300.150

REF. MERCEDES

541 130 22 19

541 130 27 19



Placa de compresor / Plate head compressor

REF. AIR-FREN

01.391.1300

REF. MERCEDES

541 130 08 20

Kit reparación / Repair kit

REF. AIR-FREN

01.R391.142



Mercedes-Benz



Cilindro-Pistón/90 Mercedes Actros / Cylinder Piston/90

| REF. AIR-FREN | REF. MERCEDES | REF. MAN |
|---------------|--------------------------------|----------------|
| 01.2300.10 | 442 130 00 08 403 131 20 02 | 51 54105 60 06 |

Refrigerado por Agua / Water-cooling



Cilindro-Pistón/90 Mercedes Actros / Cylinder Piston/90

| REF. AIR-FREN | REF. MERCEDES | REF. MAN |
|---------------|--------------------------------|----------------|
| 01.2300.20 | 402 130 06 08 402 131 05 02 | 51 54105 60 08 |

Refrigerado por Aire / Air-cooling



Cilindro-Pistón/100 Mercedes Actros / Cylinder Piston/100

| REF. AIR-FREN | REF. MERCEDES | REF. MAN |
|---------------|---------------|----------------------------|
| 01.2300.30 | - | 54 11300 01 08 + pistón |

Refrigerado por Aire / Air-cooling



Placas de compresor / Compressor plates

| REF. AIR-FREN | REF. WABCO |
|---------------|---------------|
| 01.391.200 | 411.141.501.2 |

ø 75 mm.



Placas de compresor / Compressor plates

| REF. AIR-FREN | REF. WABCO |
|---------------|------------|
| 01.391.002 | 402.426.4 |

ø 90 mm.



Placas compresor Mercedes Serie 400 / Mercedes 400 Plate head compressor

| REF. AIR-FREN | REF. KNORR | PARA / FOR CULATA HEAD COMPRESSOR |
|---------------|----------------------|---|
| 01.391.1100 | ZB-4129 SEB-22103 | ZB-4187; ZB-4224 ZB-4114; 0480099002 |

MERCEDES: Para / for compressor LP-1828; LP-1950; LP-1969; LP-3842



Kit laminillas / Lamelles kit

ø 75

REF. AIR-FREN

KNORR

01.R391.102



ø 90

REF. AIR-FREN

MAN

01.R391.106



ø 80

REF. AIR-FREN

BENDIX

01.R391.107



ø 100

REF. AIR-FREN

MERCEDES
ACTROS

01.R391.109



ø 85

REF. AIR-FREN

MERCEDES
BUS CITARO

01.R391.111

Compressor 412.636.000.0

Placa de compresor Iveco / Plate Head Compressor

| REF. AIR-FREN | REF. IVECO | PARA / FOR COMPRESSOR |
|---------------|------------|---|
| 01.391.850 | 79035554 | AC61ZA/ZB AC63ZA/ZB AC64ZB ACX66C ACX66CG |

IVECO

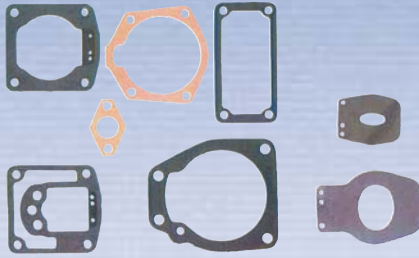
Kit juntas + válvulas Iveco / Repair kit

| REF. AIR-FREN | PARA / FOR COMPRESSOR |
|---------------|---|
| 01.R391.127 | AC61ZA/ZB AC63ZA/ZB AC64ZB ACX66C ACX66CG |

IVECO

Placa de compresor Iveco / Plate Head Compressor

| REF. AIR-FREN | REF. IVECO | PARA / FOR COMPRESSOR |
|---------------|------------|---------------------------|
| 01.391.900 | 79035741 | AC67A AC67AC ACX67A |

IVECO

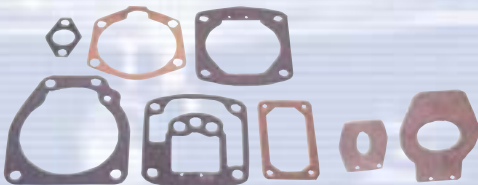
Kit juntas + válvulas Iveco / Repair kit

| REF. AIR-FREN | PARA / FOR COMPRESSOR |
|---------------|---------------------------|
| 01.R391.129 | AC67A AC67AC ACX67A |

IVECO

Placa de compresor Iveco / Plate Head Compressor

| REF. AIR-FREN | REF. IVECO | PARA / FOR COMPRESSOR |
|---------------|------------|-----------------------------|
| 01.391.950 | 93161485 | ACX68A ACX68AS ACX68D |

IVECO

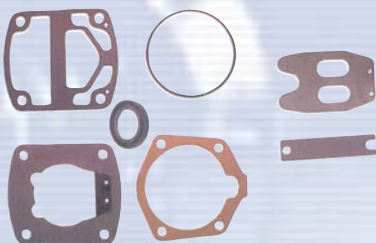
Kit juntas + válvulas Iveco / Repair kit

| REF. AIR-FREN | PARA / FOR COMPRESSOR |
|---------------|-----------------------------|
| 01.R391.130 | ACX68A ACX68AS ACX68D |

IVECO



Placa de compresor Iveco / Plate Head Compressor

| REF. AIR-FREN | REF. IVECO | PARA / FOR COMPRESSOR |
|---------------|------------|---|
| 01.391.1000 | 93161841 | ACX69A; ACX69AS ACX69CX; ACX69D ACX69DX |

IVECO

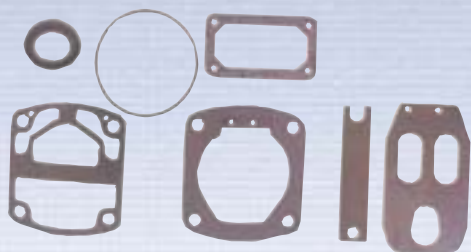

Kit juntas + válvulas Iveco / Repair kit

| REF. AIR-FREN | PARA / FOR COMPRESSOR |
|---------------|---|
| 01.R391.131 | ACX69A; ACX69AS ACX69CX; ACX69D ACX69DX |

IVECO

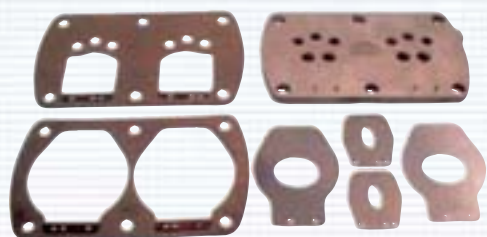

Placa de compresor Iveco / Plate Head Compressor

| REF. AIR-FREN | REF. IVECO | PARA / FOR COMPRESSOR |
|---------------|----------------------|-----------------------|
| 01.391.1050 | 79098367 93161594 | AC75ZA ACX75ZA |

IVECO

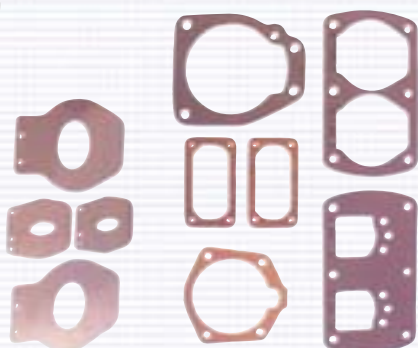

Kit juntas + válvulas Iveco / Repair kit

| REF. AIR-FREN | PARA / FOR COMPRESSOR |
|---------------|-----------------------|
| 01.R391.132 | AC75ZA ACX75ZA |

IVECO

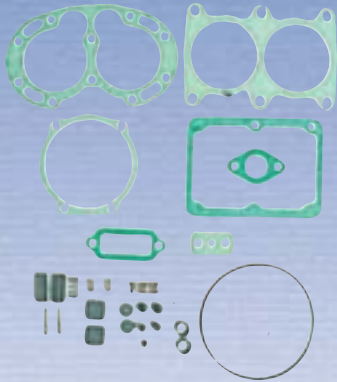

Kit reparación / Repair kit
Bendix TUFLO 500 - TUFLO 700

REF. AIR-FREN

REF. VOLVO

01.R391.117

272813

VOLVO

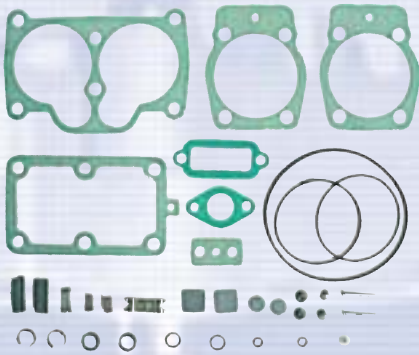

Kit reparación / Repair kit
Bendix TUFLO 501

REF. AIR-FREN

REF. VOLVO

01.R391.118

272878

VOLVO

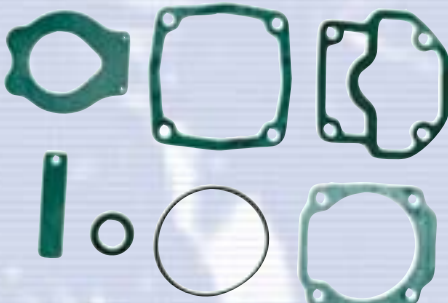

Kit reparación / Repair kit
Compressor LK-1813

REF. AIR-FREN

PARA / FOR COMPRESSOR

01.R391.126

LK-1813



Kit juntas + válvulas Iveco / Repair kit

| REF. AIR-FREN | PARA / FOR COMPRESSOR |
|---------------|----------------------------|
| 01.R391.128 | AC63ZA AC63ZB AC64ZB |

IVECO

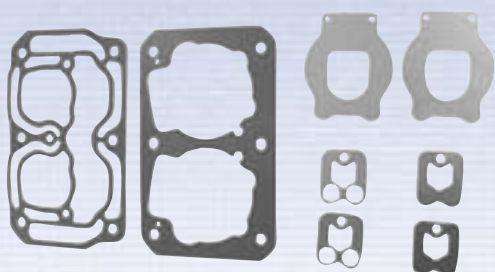

Kit juntas + válvulas Iveco / Repair kit

| REF. AIR-FREN | PARA / FOR COMPRESSOR |
|---------------|--------------------------------|
| 01.R391.135 | 911.506.504.0 911.506.505.0 |

IVECO



Kit juntas + válvulas Iveco / Repair kit

| REF. AIR-FREN | REF. IVECO | PARA / FOR COMPRESSOR |
|---------------|------------|--|
| 01.R391.134 | 93161793 | WABCO 911.145.060.0 911.145.500.0 911.145.560.0 |

IVECO

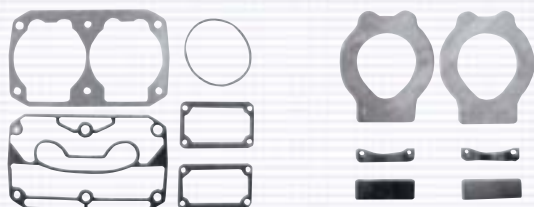

Kit juntas + válvulas Iveco / Repair kit

| REF. AIR-FREN | REF. IVECO | REF. KNORR | PARA / FOR COMPRESSOR |
|---------------|----------------------|----------------------|---------------------------------|
| 01.R391.139 | 42534245 42534247 | SK3043/1 SK3040/1 | KNORR 1194410 IVECO 99471918 |

IVECO

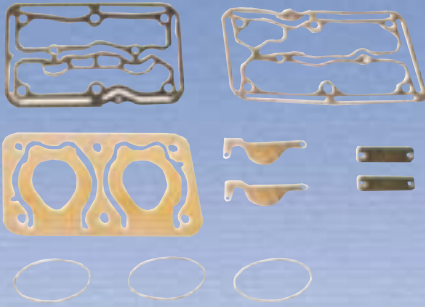

REF. AIR-FREN

01.R391.144

Para / For MERCEDES 457 130 18 15



REF. AIR-FREN

01.R391.145

Para / For MERCEDES 457 130 15 15
 457 130 20 15



REF. AIR-FREN

01.R391.146

Para / For MAN 51 54100 60 15

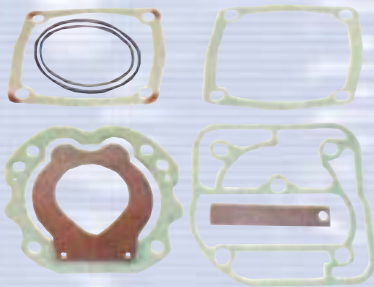

REF. AIR-FREN

01.R391.147

Para / For MERCEDES - MAN



REF. AIR-FREN

01.R391.148

Para / For MAN 51 54114 7002

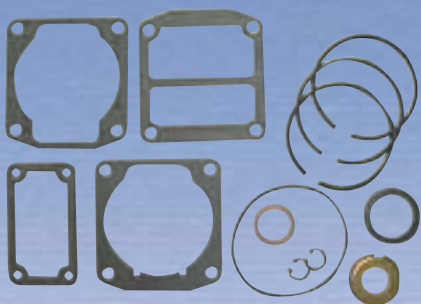

Kit reparación compresor Bendix Ø80 / Repair kit

| REF. AIR-FREN | REF. IVECO |
|---------------|------------|
| 01.R197694 | 197.694 |
| 01.R197695* | 197.695 |

IVECO, PEGASO

*: Solo segmentos / Only Orings Piston



Kit reparación compresor Ø75 mm / Repair kit

| REF. AIR-FREN | REF. WABCO |
|---------------|------------|
| 01.R196.052 | 404.592.6 |

IVECO, PEGASO



Kit segmentos compresor / Repair kit

| REF. AIR-FREN | REF. WABCO | REF. IVECO |
|---------------|------------|----------------------|
| 01.R178.054 | 404.442.6 | 178.054 500006731 |

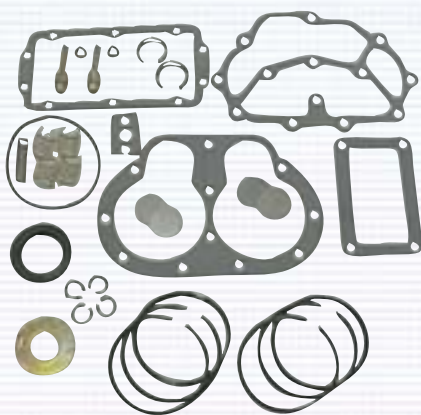

Kit reparación compresor bici Pegaso 310 CV / Repair kit

| REF. AIR-FREN | REF. WABCO |
|---------------|------------|
| 01.R192.164 | 404.596.2 |

IVECO, PEGASO



Filtro de aire seco / Air filter

| REF. AIR-FREN | REF. WABCO |
|---------------|---------------|
| 01.7000.10 | 432.603.000.0 |



Calderines de aire / Air tanks

| REF. AIR-FREN | CAPACIDAD CAPACITY | MEDIDAS MEASURES |
|---------------|-----------------------|---------------------|
| 01.2590.05 | 5 l. | 160 x 300 |
| 01.2060.10 | 10 l. | 206 x 355 |
| 01.2060.20 | 20 l. | 206 x 690 |
| 01.2460.20 | 20 l. | 246 x 500 |
| 01.2460.30 | 30 l. | 246 x 700 |
| 01.2760.40 | 40 l. | 276 x 745 |
| 01.3100.40 | 40 l. | 310 x 600 |
| 01.2760.60 | 60 l. | 276 x 1.100 |
| 01.3100.60 | 60 l. | 310 x 880 |
| 01.3960.60 | 60 l. | 396 x 565 |
| 01.3960.100 | 100 l. | 396 x 900 |
| 01.2760.40 E | 40 l. | 276 x 745 |
| 01.3100.60 E | 60 l. | 310 x 880 |
| 01.2760.60 E | 60 l. | 276 x 1.100 |

Kit abrazaderas / Kit clamp assy

| REF. AIR-FREN | Ø |
|---------------|-----|
| 01.2060.00 | 206 |
| 01.2460.00 | 246 |
| 01.2760.00 | 276 |
| 01.3100.00 | 310 |
| 01.3960.00 | 396 |

Calderines de aluminio / Aluminium Air tanks

| REF. AIR-FREN | CAPACIDAD CAPACITY | MEDIDAS MEASURES |
|---------------|-----------------------|---------------------|
| 01.3100.40 A | 40 l. | 310 x 600 |
| 01.3100.60 A | 60 l. | 310 x 880 |

Polea simple / Simple pulley

| REF. AIR-FREN | REF. TACA |
|---------------|-----------|
| 01.4060.10 | 259.406.0 |

Polea doble / Double pulley

| REF. AIR-FREN | REF. TACA |
|---------------|-----------|
| 01.4070.10 | 259.407.0 |

02

CILINDROS, ACTUADORES Y CÁMARAS DE FRENO

*CYLINDERS, ACTUATORS
AND BRAKE CHAMBERS*

CILINDROS, ACTUADORES Y CÁMARAS DE FRENO / CYLINDERS, ACTUATORS AND BRAKE CHAMBERS

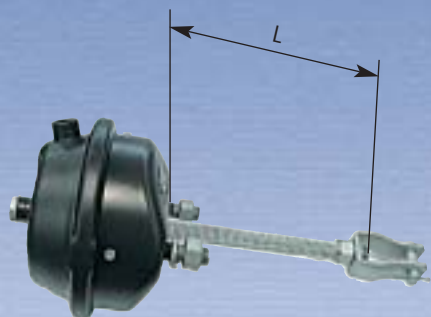

| Cámaras de freno / Brake chambers | | | | |
|-----------------------------------|-------------|-----------------|--------|---------------------|
| REF. AIR-FREN | REF. WABCO | PULGADAS INCHES | L (MM) | CARRERA STROKE (MM) |
| 02.239.009.1 | 423.102...0 | 9" | 210 | 44,5 |
| 02.239.012.1 | 423.103...0 | 12" | 190 | 44,5 |
| 02.239.016.1 | 423.104...0 | 16" | 190 | 75 |
| 02.239.020.1 | 423.105...0 | 20" | 200 | 75 |
| 02.239.024.1 | 423.106...0 | 24" | 200 | 75 |
| 02.239.030.1 | 423.107...0 | 30" | 190 | 75 |
| 02.239.036.1 | 423.008...0 | 36" | 200 | 75 |

CARRERA LARGA / LONG STROKE

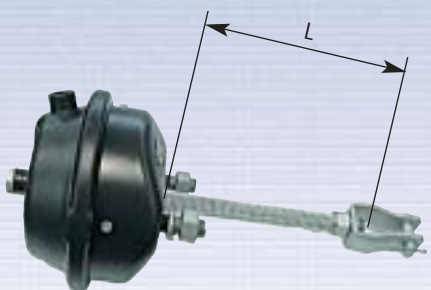

| Cámaras de freno / Brake chambers | | | | |
|-----------------------------------|------------|-----------------|--------|---------------------|
| REF. AIR-FREN | REF. WABCO | PULGADAS INCHES | L (MM) | CARRERA STROKE (MM) |
| 02.239.020.1C | 417.013.6 | 20" | 210 | 57 |
| 02.239.024.1C | 424.094.3 | 24" | 261 | 57 |
| 02.239.030.1C | 430.009.4 | 30" | 261 | 64 |

CARRERA CORTA / SHORT STROKE

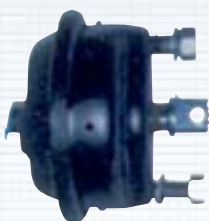

| Cámaras de freno / Brake chambers | | | | |
|-----------------------------------|---------------|-----------------|--------|---------------------|
| REF. AIR-FREN | REF. WABCO | PULGADAS INCHES | L (MM) | CARRERA STROKE (MM) |
| 02.239.020.2 | 423.105.407.0 | 20" | 37 | 57 |
| 02.239.024.2 | 423.106.106.0 | 24" | 37 | 57 |

CARRERA CORTA / SHORT STROKE

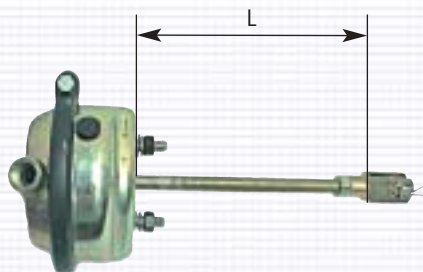

| Cámaras de freno / Brake chambers 20" pulgadas / inches | | | | |
|--|------------|-------------|--------|---------------------|
| REF. AIR-FREN | REF. WABCO | REF. PEGASO | L (MM) | CARRERA STROKE (MM) |
| 02.239.020.1EE | 417.060.4 | 199.001 | 240 | 57 |
| | 417.063.1 | 750.383 | | |
| | | 637.646 | | |
| | | 637.647 | | |

DISTANCIA DE AMARRE 80 MM. / DISTANCE TO TIE UP 80 MM.



| Cámaras de freno / Brake chambers | | |
|-----------------------------------|----------------------|---------------------|
| REF. AIR-FREN | REF. KNORR | CARRERA STROKE (MM) |
| 02.6754.00 | 1186754 1186754XU | 40 |

CILINDROS, ACTUADORES Y CÁMARAS DE FRENO / CYLINDERS, ACTUATORS AND BRAKE CHAMBERS



Cámara de 36" c/Rodillo / Brake chamber

| REF. AIR-FREN | REF. BPW |
|---------------|----------------|
| 02.239.036.2 | 05.444.10.37.0 |

BPW, Lecitrailer



Cámara tipo cuña / Brake chamber

| REF. AIR-FREN | REF. KNORR / REF. WABCO | PULGADAS INCHES |
|---------------|----------------------------|--------------------|
| 02.1609.00 | BZ-3106 423.142.001.0 | 9" |

IVECO; L= 138 mm.; CARRERA / STROKE= 44,5 mm.



| REF. AIR-FREN | REF. KNORR | PULGADAS INCHES |
|---------------|------------|--------------------|
| 02.1612.00 | BZ-3217* | 12" |
| 02.1612.10 | BZ-3218** | 12" |

IVECO; * L= 138 mm.; CARRERA / STROKE= 44,5 mm.

** L= 365 mm.; CARRERA / STROKE= 50 mm.

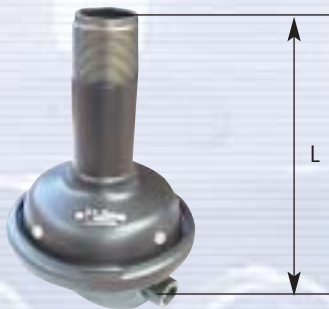

| REF. AIR-FREN | REF. KNORR / REF. WABCO | PULGADAS INCHES |
|---------------|---|--------------------|
| 02.1612.20 | 423.143.004.0 BZ-3214 BZ-3221 BZ-3224 BY-3202 | 12" |

IVECO, RENAULT, MAN; L= 188 mm.



Cámaras para freno disco / Disc brake chambers

| REF. AIR-FREN | REF. WABCO / REF. KNORR | PULGADAS INCHES | CARRERA STROKE (MM) |
|---------------|----------------------------|--------------------|------------------------|
| 02.239.014.6 | BS-3251 | 14" | 57 |
| 02.239.016.6 | 423.104.710.0 | 16" | 57 |
| 02.239.018.6 | BS-3352 | 18" | 64 |
| 02.239.020.6 | BS-3404 | 20" | 57 |
| 02.239.022.6 | BS-3451 | 22" | 57 |
| 02.239.024.6 | BS-3509 | 24" | 57 |
| 02.239.030.6 | BS-3601 | 30" | 64 |

MERCEDES, BPW

CILINDROS, ACTUADORES Y CÁMARAS DE FRENO / CYLINDERS, ACTUATORS AND BRAKE CHAMBERS

Actuador tristorp aligerado / Tristorp spring brake actuator



| REF. AIR-FREN | REF. WABCO / REF. KNORR | PULGADAS INCHES | CARRERA STROKE (MM) |
|---------------|----------------------------|--------------------|------------------------|
| 02.0916.30 | - | 9 / 16 | 45 |
| 02.0920.30 | - | 9 / 20 | 45 |
| 02.1216.30 | 425.446.002.0 | 12 / 16 | 45 |
| 02.1220.30 | - | 12 / 20 | 54 |
| 02.1424.30 | - | 14 / 24 | 57 |
| 02.1616.30 | 925.324.801.0 | 16 / 16 * | 57 |
| 02.1624.30 | 925.324.982.0 | 16 / 24 | 57 |
| 02.1824.30 | - | 18 / 24 | 57 |
| 02.2024.30 | 925.320.974.0 | 20 / 24 | 57 |
| 02.2030.30 | 925.320.979.0 | 20 / 30 | 57 |
| 02.2424.30 | 925.421.982.0 | 24 / 24 | 57 |
| 02.2430.30 | - | 24 / 30 | 57 |
| 02.2724.30 | BZ-9555 | 27 / 24 | 64 |
| 02.2730.30 | - | 27 / 30 | 64 |
| 02.3030.30 | 925.322.966.0 | 30 / 30 | 64 |
| 02.3630.30 | 925.323.981.0 | 36 / 30 | 64 |

MERCEDES, MAN, VOLVO, SCANIA, RVI.... (*) Roscas Tipo Voss

Actuador tristorp completo / Tristorp spring brake actuator

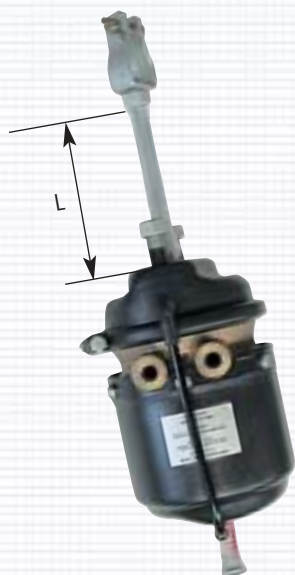

| REF. AIR-FREN | REF. WABCO / REF. KNORR | PULGADAS INCHES | L (MM) | CARRERA STROKE (MM) |
|---------------|----------------------------|--------------------|-----------|------------------------|
| 02.0916.00 | - | 9 / 16 | 290 | 45 / 45 |
| 02.0920.00 | - | 9 / 20 | 290 | 45 / 45 |
| 02.1216.00 | 925.325.200.0 | 12 / 16 | 290 | 45 / 45 |
| 02.1220.00 | - | 12 / 20 | 290 | 54 / 54 |
| 02.1416.00 | - | 14 / 16 | 240 | 57 / 57 |
| 02.1616.00 | - | 16 / 16* | 320 | 57 / 57 |
| 02.1624.00 | 925.324.000.0 | 16 / 24 | 320 | 57 / 57 |
| 02.2020.00 | 925.300.046.0 | 20 / 20 | 365 | 57 / 57 |
| 02.2024.00 | 925.420.100.0 | 20 / 24 | 260 | 57 / 57 |
| 02.2030.00 | 925.320.500.0 | 20 / 30 | 328 | 57 / 57 |
| 02.2424.00 | 925.421.100.0 | 24 / 24 | 174 | 57 / 57 |
| 02.2430.00 | 925.321.400.0 | 24 / 30 | 216 | 57 / 57 |
| 02.2724.00 | BZ-9555 | 27 / 24 | 30 | 64 / 64 |
| 02.2730.00 | 925.429.002.0 | 27 / 30 | 280 | 64 / 64 |
| 02.3024.00 | 925.432.410.0 | 30 / 24 | 301 | 64 / 64 |
| 02.3030.00 | 925.322.125.0 | 30 / 30 | 320 | 64 / 64 |
| 02.3630.00 | 925.303.000.0 | 36 / 30 | 195 | 75 / 64 |

MERCEDES, MAN, VOLVO, SCANIA, RVI.... (*) Roscas Tipo Voss

CILINDROS, ACTUADORES Y CÁMARAS DE FRENO / CYLINDERS, ACTUATORS AND BRAKE CHAMBERS

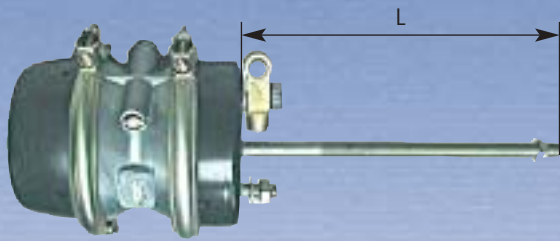

Actuador doble diafragma / Spring brake actuator

| REF. AIR-FREN | REF. WABCO | PULGADAS INCHES |
|---------------|------------|-----------------|
| 02.1624.80 | - | 16 / 24 |

SEMIRREMOLQUES, L= 320 mm., CARRERA / STROKE= 64/64

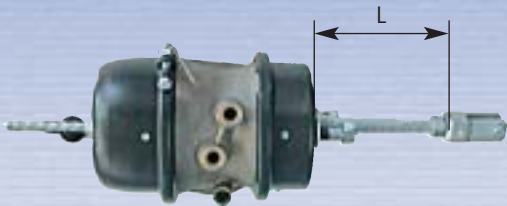

Actuador doble diafragma / Spring brake actuator

| REF. AIR-FREN | REF. WABCO | PULGADAS INCHES |
|---------------|------------|-----------------|
| 02.2024.80 | - | 20 / 24 |

SEMIRREMOLQUES, R.O.R., L= 400 mm., CARRERA / STROKE= 64/64

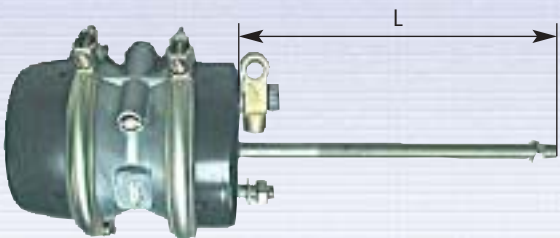

Actuador doble diafragma / Spring brake actuator

| REF. AIR-FREN | REF. WABCO | PULGADAS INCHES |
|---------------|------------|-----------------|
| 02.2424.80 | - | 24 / 24 |

SEMIRREMOLQUES, FRUEHAUF, L= 330 mm., CARRERA / STROKE= 75/75

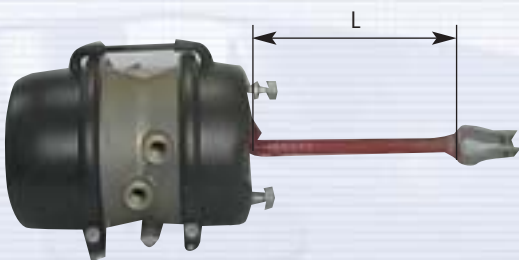

Actuador doble diafragma / Spring brake actuator

| REF. AIR-FREN | REF. WABCO | PULGADAS INCHES |
|---------------|---------------|-----------------|
| 02.2430.80 | 925.371.307.0 | 24 / 30 |

SEMIRREMOLQUES, L= 208 mm., CARRERA / STROKE= 75/75

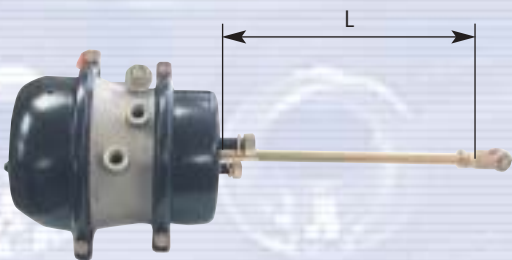

Actuador doble diafragma / Spring brake actuator

| REF. AIR-FREN | REF. WABCO | PULGADAS INCHES |
|---------------|------------|-----------------|
| 02.2430.80C | - | 24 / 30 |

SEMIRREMOLQUES, L= 320 mm., CARRERA / STROKE= 64/64

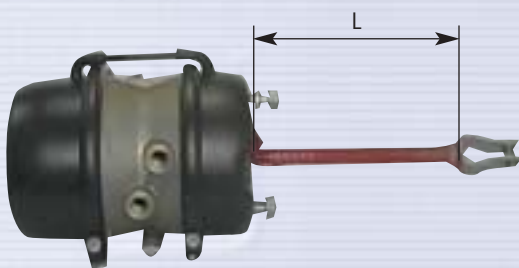

Actuador doble diafragma / Spring brake actuator

| REF. AIR-FREN | REF. WABCO | PULGADAS INCHES |
|---------------|--------------------------------|-----------------|
| 02.3030.80 | 925.372.307.0 925.372.300.0 | 30 / 30 |

SEMIRREMOLQUES, L= 185 mm., CARRERA / STROKE= 64/64

CILINDROS, ACTUADORES Y CÁMARAS DE FRENO / CYLINDERS, ACTUATORS AND BRAKE CHAMBERS

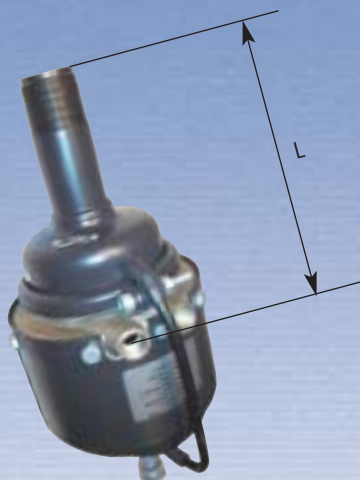

Actuador cuña rosca / Spring brake actuator

| REF. AIR-FREN | PULGADAS INCHES | REF. KNORR | L (MM) | CARRERA STROKE (MM) |
|---------------|-----------------|------------|--------|---------------------|
| 02.0916.70 | 9 / 16 | - | 187 | 44,5 / 44,5 |
| 02.0920.70 | 9 / 20 | - | 187 | 44,5 / 44,5 |
| 02.1216.70 | 12 / 16 | - | 157 | 44,5 / 44,5 |
| 02.1220.70 | 12 / 20 | - | 187 | 44,5 / 44,5 |
| 02.1424.70 | 14 / 24 | BY-9260 | 190 | 57 / 57 |
| 02.1824.70 | 18 / 24 | BY-9350 | 190 | 57 / 57 |
| 02.2024.70 | 20 / 24 | - | 190 | 57 / 57 |
| 02.2224.70 | 22 / 24 | - | 190 | 64 / 64 |
| 02.2424.70 | 24 / 24 | BY-9501 | 190 | 57 / 57 |

IVECO, RVI, DAF



Actuador cuña 4 taladros / Spring brake actuator

| REF. AIR-FREN | PULGADAS INCHES | REF. KNORR | L (MM) | CARRERA STROKE (MM) |
|---------------|-----------------|------------|--------|---------------------|
| 02.0916.90 | 9 / 16 | BY-7106 | 180 | 53 / 44,5 |
| 02.1216.90 | 12 / 16 | BY-7203 | 180 | 53 / 44,5 |

IVECO, RVI, DAF
Roscas Tipo Voss



Actuador para frenos disco / Disc actuator

| REF. AIR-FREN | REF. KNORR / REF. WABCO | PULGADAS INCHES |
|---------------|-------------------------|-----------------|
| 02.1424.60 | BS-9259 | 14 / 24 |
| 02.1616.60 | 925.464.452.0 | 16 / 16 |
| 02.1624.60 | - | 16 / 24 |
| 02.2024.60 | BS-9404 | 20 / 24 |
| 02.2030.60 | - | 20 / 30 |
| 02.2424.60 | 925.481.012.0 | 24 / 24 |
| 02.2430.60 | BS-9527 | 24 / 30 |

CARRERA / STROKE= 57/57 mm.



Actuador doble diafragma para freno disco / Spring brake actuator

| REF. AIR-FREN | PULGADAS INCHES |
|---------------|-----------------|
| 02.1424.50 | 14 / 24 |
| 02.1624.50 | 16 / 24 |
| 02.1824.50 | 18 / 24 |
| 02.2024.50 | 20 / 24 |
| 02.2424.50 | 24 / 24 |
| 02.2430.50 | 24 / 30 |

CARRERA / STROKE= 57/57 mm.

CILINDROS, ACTUADORES Y CÁMARAS DE FRENO / CYLINDERS, ACTUATORS AND BRAKE CHAMBERS



Actuadores aligerados tipo MGM / Spring brake actuators type MGM

| REF. AIR-FREN | REF. WABCO | PULGADAS INCHES | Kit reparación / Repair kit | |
|---------------|------------|-----------------|-----------------------------|------------|
| | | | REF. AIR-FREN | REF. WABCO |
| 02.1600.50 | - | 20" | 02.R5050 | - |
| 02.1800.30 | 400.759.3 | 24" | 02.R1800E | 401.328.6 |
| 02.9000.30 | 400.492.7 | 30" | 02.R9000 | 401.308.0 |

IVECO, PEGASO, RVI



Actuadores completos tipo MGM / Spring brake actuator type MGM

| REF. AIR-FREN | REF. WABCO | PULGADAS INCHES | Kit reparación / Repair kit | |
|---------------|------------|-----------------|-----------------------------|------------|
| | | | REF. AIR-FREN | REF. WABCO |
| 02.1600.20 | - | 20" | 02.R5050 | - |
| 02.1800.00 | 414.523.1 | 24" | 02.R1800M | 401.644.1 |
| 02.9000.40 | 413.009.3 | 30" | 02.R9000E | 401.646.9 |

IVECO, PEGASO, RVI



Cilindro doble Man / Brake cylinder

| 125-90 / 150 | | Kit reparación / Repair kit | |
|---------------|------------|-----------------------------|------------|
| REF. AIR-FREN | REF. KNORR | REF. AIR-FREN | REF. KNORR |
| 02.2070.00 | BZ-6621 | 02.R2070 | I-67587 |

MAN

| 115-90 / 150 | | Kit reparación / Repair kit | |
|---------------|------------|-----------------------------|------------|
| REF. AIR-FREN | REF. KNORR | REF. AIR-FREN | REF. KNORR |
| 02.2080.00 | BZ-6517 | 02.R2080 | I-69698 |

MAN

CILINDROS, ACTUADORES Y CÁMARAS DE FRENO / CYLINDERS, ACTUATORS AND BRAKE CHAMBERS

Diafragma curso corto / Short stroke diaphragm



| REF. AIR-FREN | REF. WABCO | PULGADAS INCHES |
|---------------|---------------|--------------------|
| 02.1609 | 897.120.495.4 | 9" |
| 02.1612 | 897.120.505.4 | 12" |
| 02.1614 | 897.120.610.4 | 14" |
| 02.1616 | 897.120.510.4 | 16" |
| 02.1601 | 897.120.520.4 | 20" |
| 02.1802 | 897.120.530.4 | 24" |
| 02.1651 | 897.120.540.4 | 30" |

Diafragma curso largo / Long stroke diaphragm



| REF. AIR-FREN | REF. WABCO | PULGADAS INCHES |
|---------------|---------------|--------------------|
| 02.1609L | - | 9" |
| 02.1612L | 897.120.507.4 | 12" |
| 02.1614L | 897.120.615.4 | 14" |
| 02.1616L | 897.120.516.4 | 16" |
| 02.1601L | 897.120.526.4 | 20" |
| 02.1622L | 897.121.922.4 | 22" |
| 02.1802L | 897.120.536.4 | 24" |
| 02.1627L | - | 27" |
| 02.1651L | 897.120.546.4 | 30" |
| 02.1636L | 897.120.550.4 | 36" |

Diafragma curso intermedio / Medium stroke diaphragm



| REF. AIR-FREN | REF. WABCO | PULGADAS INCHES |
|---------------|---------------|--------------------|
| 02.1609W | 897.120.495.4 | 9" |
| 02.1612W | - | 12" |
| 02.1616W | - | 16" |
| 02.1601W | - | 20" |
| 02.1627W | 897.120.547.4 | 27" |
| 02.1802W | 897.120.535.4 | 24" |
| 02.1651W | - | 30" |

Diafragma para actuador freno de disco / Diaphragm for disc actuator



| REF. AIR-FREN | REF. KNORR | PULGADAS INCHES |
|---------------|------------|--------------------|
| 02.1616K | 2C72596 | 16" |
| 02.1601K | 2C72336 | 20" |
| 02.1802K | 2C72337 | 24" |



| REF. AIR-FREN | REF. WABCO | PULGADAS INCHES |
|---------------|---------------|--------------------|
| 02.1214 | - | 12 / 14 |
| 02.1216 | 897.121.923.4 | 12 / 16 |

CILINDROS, ACTUADORES Y CÁMARAS DE FRENO / CYLINDERS, ACTUATORS AND BRAKE CHAMBERS

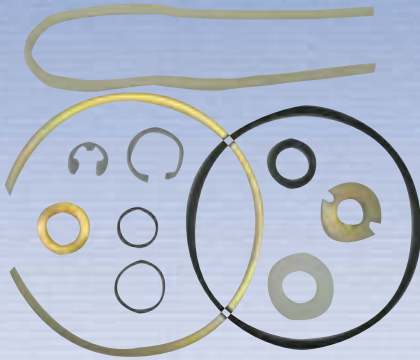

Conjuntos reparación actuadores / Only actuators repair kits

| REF. AIR-FREN | REF. TACA | REF. WABCO | ACTUADOR |
|---------------|----------------|------------|----------|
| 02.R1600 | 238.020.61.100 | - | 20" CM |
| 02.R5050 | 238.021.51.100 | - | 20"CM |
| 02.R1800 | 239.024.01.100 | - | 24" CM |
| 02.R5700 | 238.024.41.100 | - | 24" CM |
| 02.R1800E | 238.024.01.100 | 401.328.6 | 24" SM |
| 02.R1800M | 238.024.11.100 | 401.644.1 | 24" CM |
| 02.R1650 | 238.031.01.100 | - | 30" CM |
| 02.R1650E | 238.031.01.300 | - | 30" SM |
| 02.R9000 | 238.038.01.100 | 401.308.0 | 30" SM |
| 02.R9000E | 238.038.01.200 | 401.646.9 | 30"CM |
| 02.R9000N | 238.038.51.100 | 401.482.5 | 30" SM |
| 02.R5150 | 238.038.71.100 | - | 30" CM |

CM: CON MEMBRANA / WITH DIAPHRAGM

SM: SIN MEMBRANA / WITHOUT DIAPHRAGM

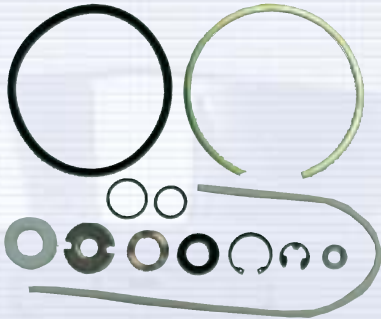

Kit reparación actuador 20 "Wabco / Actuador 20" repair kit

| REF. AIR-FREN | REF. WABCO | REF. PEGASO | ACTUADOR |
|---------------|------------|-------------|----------|
| 02.R584.622 | 401.326.8 | 584.622 | 20" SM |
| 02.R589.757 | 401.643.2 | 589.757 | 20" CM |

CM: CON MEMBRANA / WITH DIAPHRAGM

SM: SIN MEMBRANA / WITHOUT DIAPHRAGM



Tapa actuador / Front cover

| REF. AIR-FREN | PULGADAS INCHES |
|---------------|--------------------|
| 02.1616.05 | 16" |
| 02.2020.05 | 20" |
| 02.2424.05 | 24" |
| 02.3030.05 | 30" |

CILINDROS, ACTUADORES Y CÁMARAS DE FRENO / CYLINDERS, ACTUATORS AND BRAKE CHAMBERS

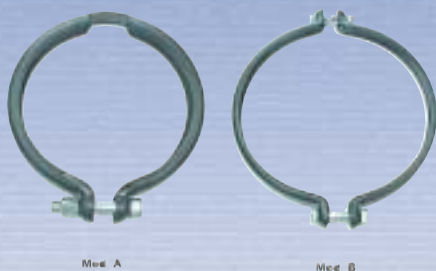

Abrazadera Actuador / Clamp Assy

| REF. AIR-FREN | PULGADAS INCHES | MODELO / TYPE |
|---------------|--------------------|------------------|
| 02.0900.13 | 09" | A |
| 02.1200.13 | 12" | A |
| 02.1600.13 | 16" | A |
| 02.2000.13 | 20" | A |
| 02.2400.13 | 24" | B |
| 02.2700.13 | 27" | A |
| 02.3000.13 | 30" | A |
| 02.3600.13 | 36" | B |



Dedo de empuje / Push rod Assy

| REF. AIR-FREN | PULGADAS INCHES |
|---------------|--------------------|
| 02.1616.06 | 16" |
| 02.2020.06 | 20" |
| 02.2424.06 | 24" |
| 02.3030.06 | 30" |



Horquilla / Yoke

| REF. AIR-FREN | MEDIDAS MEASURES |
|---------------|---------------------|
| 02.03561209 | M16x1.5 D-12 mm |
| 02.03561409 | M16x1.5 D-14 mm |
| 02.03561609 | M16x1.5 D-16 mm |

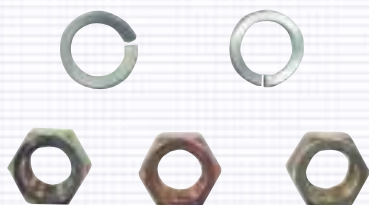

Muelle para cámara / Spring for Brake Chamber

| REF. AIR-FREN | REF. WABCO | TIPO / TYPE |
|---------------|------------------------|------------------|
| 02.1805 | 400.360.5 402.392.4 | Cónico / Conical |

Muelle para cámara / Spring for Brake Chamber

| REF. AIR-FREN | TIPO / TYPE |
|---------------|-----------------------------|
| 02.1685.91 | Cilíndrico / Cylindrical |

Muelle potencia T-30" y T-24" / Spring for Actuators

| REF. AIR-FREN | REF. WABCO |
|---------------|------------|
| 02.9000.91 | 400.361.4 |

Muelle potencia T-30N / Spring

| REF. AIR-FREN | REF. WABCO |
|---------------|------------|
| 02.1831.91 | 401.352.1 |

**Tapón actuador T-30" y T-24"
Rubber Plug actuator T-30" and T-24"**

| REF. AIR-FREN | REF. WABCO |
|---------------|------------|
| 02.1701.1 | 402.305.4 |

CILINDROS, ACTUADORES Y CÁMARAS DE FRENO / CYLINDERS, ACTUATORS AND BRAKE CHAMBERS

Cilindros de freno simple / Single spring brake cylinders

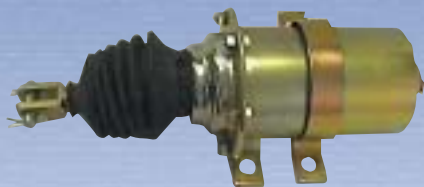

Kit reparación / Repair kit

| REF. AIR-FREN | REF. TACA | REF. AIR-FREN | FABRICACIÓN |
|---------------------------|------------------------|-----------------------|--------------------------|
| 02.1350.20 02.1350.20E | 235.100.2 235.100.2 | 02.R1350 02.R1350E | Hasta 2008 Desde 2008 |

SEMIRREMOLQUES, RVI, ø 100 mm.

Kit reparación / Repair kit

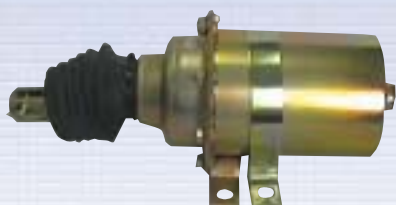

| REF. AIR-FREN | REF. TACA | REF. AIR-FREN | FABRICACIÓN |
|---------------------------|------------------------|-----------------------|--------------------------|
| 02.1400.10 02.1400.10E | 235.125.0 235.125.0 | 02.R1400 02.R1400E | Hasta 2008 Desde 2008 |

SEMIRREMOLQUES, PEGASO, RVI, ø 125 mm.

Kit reparación / Repair kit

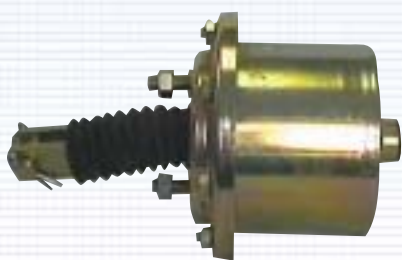

| REF. AIR-FREN | REF. TACA | REF. AIR-FREN |
|---------------|-----------|---------------|
| 02.1500.30 | 235.126.3 | 02.R1500 |

SEMIRREMOLQUES, RVI, ø 125 mm. Carrera Corta / Short Stroke

Cilindros de freno doble / Double spring brake actuator

Kit reparación / Repair kit



| REF. AIR-FREN | REF. TACA | REF. AIR-FREN |
|---------------|-----------|---------------|
| 02.1750.20 | 238.125.2 | 02.R1750 |

RVI, ø 125 mm.

CILINDROS, ACTUADORES Y CÁMARAS DE FRENO / CYLINDERS, ACTUATORS AND BRAKE CHAMBERS



Fuelles guardapolvos / Rubber boot

| REF. AIR-FREN | APLICACIÓN / APPLICATION |
|---------------|--------------------------------------|
| 02.1302 | Cilindros de freno Brake cylinder |

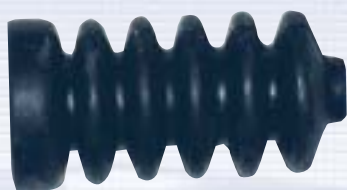

| REF. AIR-FREN | APLICACIÓN / APPLICATION |
|---------------|-----------------------------------|
| 02.1302.1 | Cámaras de freno Brake chamber |

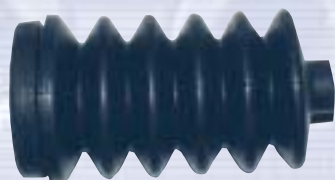

| REF. AIR-FREN | APLICACIÓN / APPLICATION |
|---------------|--------------------------|
| 02.1302.2 | Actuadores Actuators |

03

VÁLVULAS DE PEDAL
FOOT VALVES





| REF. AIR-FREN | REF. GRAU |
|---------------|-------------|
| * 03.1900.00 | 320.015.001 |
| ** 03.1900.20 | 320.018.001 |

| Kit reparación / Repair kit | |
|-----------------------------|-------------|
| REF. AIR-FREN | REF. GRAU |
| 03.R1900 | 950.320.010 |
| 03.R1900 | 950.320.010 |

MAN, MAGIRUS, RVI
 * M 22x1,5
 ** M 16x1,5



| REF. AIR-FREN | REF. TACA |
|---------------|-----------|
| 03.1900.30 | 240.015.3 |

| Kit reparación / Repair kit | |
|-----------------------------|----------------|
| REF. AIR-FREN | REF. TACA |
| 03.R1900 | 240.015.11.100 |

EBRO, NISSAN



| REF. AIR-FREN | REF. TACA |
|---------------|-----------|
| 03.1900.10 | 240.015.1 |

| Kit reparación / Repair kit | |
|-----------------------------|----------------|
| REF. AIR-FREN | REF. TACA |
| 03.R1900 | 240.015.11.100 |

EBRO, NISSAN



| REF. AIR-FREN | REF. GRAU |
|---------------|-------------|
| 03.240.654.0 | 320.003.103 |

EBRO, NISSAN

| Kit reparación / Repair kit | |
|-----------------------------|-------------------------------|
| REF. AIR-FREN | REF. ORIGINAL |
| 03.R2300 03.R2300E | 950.320.002 740.654.01.100 |



| REF. AIR-FREN | REF. WABCO |
|---------------|---------------|
| * 03.527003 | 461.315.008.0 |
| ** 03.527001 | 461.315.042.0 |

MAN, DAF, MERCEDES, VOLVO, PEGASO, SCANIA
 * 8 M 16 x 1,5
 ** 8 M 16 x 1,5 + 2 M 12 x 1,5

| Kit reparación / Repair kit | |
|-----------------------------|--------------------------------|
| REF. AIR-FREN | REF. WABCO |
| 03.R627001 03.R627001 | 461.315.005.2 461.315.005.2 |



| REF. AIR-FREN | REF. WABCO |
|---------------|---------------|
| 03.527004 | 461.319.008.0 |

| REF. AIR-FREN | REF. BOSCH |
|---------------|------------|
| * 03.527005 | 0481064701 |

MERCEDES, SCANIA
 * 8 M 16 x 1,5 + 3 M 12 x 1,5

| Kit reparación / Repair kit | |
|-----------------------------|---------------|
| REF. AIR-FREN | REF. WABCO |
| 03.R627002 | 461.319.007.2 |



REF. AIR-FREN

REF. WABCO

Kit reparación / Repair kit

REF. AIR-FREN

REF. WABCO

03.527006

461.315.180.0

03.R527006

461.315.924.2
461.315.907.2

SCANIA



REF. AIR-FREN

REF. BOSCH

Kit reparación / Repair kit

REF. AIR-FREN

REF. BOSCH

03.527007

0481064115

03.R527007

1487010338

VOLVO



REF. AIR-FREN

REF. WABCO

03.527008

461.317.001.0

MAN, DAF, MERCEDES, VOLVO, PEGASO, SCANIA



REF. AIR-FREN

REF. KNORR

Kit reparación / Repair kit

REF. AIR-FREN

REF. KNORR

03.4849.00

MB-4849
MB-4690

03.R4849

I-99719008

VOLVO

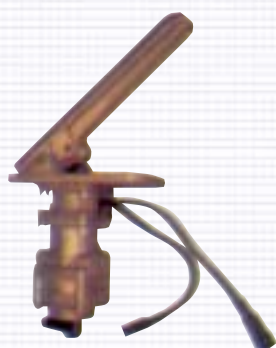

REF. AIR-FREN

REF. KNORR

03.527027

DX-80E

SCANIA



| REF. AIR-FREN | REF. WABCO |
|---------------|---------------|
| * 03.105508 | 461.307.479.0 |
| ** 03.105509 | 461.307.459.0 |

MERCEDES, DAF, VOLVO, IVECO, PEGASO
 * M 22 x 1,5
 ** M 16 x 1,5

| Kit reparación / Repair kit | |
|-----------------------------|---------------|
| REF. AIR-FREN | REF. WABCO |
| 03.R627003 | 461.307.002.2 |
| 03.R627003 | 461.307.002.2 |



| REF. AIR-FREN | REF. WABCO |
|---------------|---------------|
| 03.105510 | 461.307.200.0 |

MAN, MERCEDES

| Kit reparación / Repair kit | |
|-----------------------------|---------------|
| REF. AIR-FREN | REF. WABCO |
| 03.R627003 | 461.307.002.2 |
| 03.R627003 | 461.307.002.2 |



| REF. AIR-FREN | REF. WABCO |
|---------------|---------------|
| 03.491102 | 461.491.102.0 |

MERCEDES, DAF, MAN, VOLVO, IVECO, PEGASO

| Kit reparación / Repair kit | |
|-----------------------------|---------------|
| REF. AIR-FREN | REF. WABCO |
| 03.R627003 | 461.307.002.2 |



| REF. AIR-FREN | REF. WABCO |
|---------------|---------------|
| 03.3070.10 | 470.012.000.0 |

MERCEDES, VOLVO, DAF, MAN

| Kit reparación / Repair kit | |
|-----------------------------|---------------|
| REF. AIR-FREN | REF. WABCO |
| 03.R627003 | 461.307.002.2 |

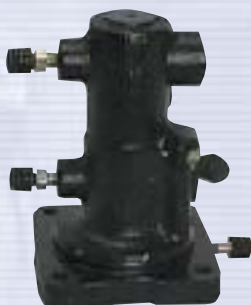

| REF. AIR-FREN | REF. WABCO |
|---------------|---------------|
| 03.3070.20 | 470.012.520.2 |

MERCEDES, VOLVO, DAF, MAN

| Kit reparación / Repair kit | |
|-----------------------------|------------|
| REF. AIR-FREN | REF. WABCO |
| 03.R1960 | - |



| Kit reparación / Repair kit | | | |
|-----------------------------|------------|---------------|------------|
| REF. AIR-FREN | REF. KNORR | REF. AIR-FREN | REF. KNORR |
| 03.527011 | MB-4630 | 03.R527011 | I-80450 |



| REF. AIR-FREN | REF. KNORR |
|---------------|------------|
| 03.527013 | MB-4821 |



| REF. AIR-FREN | REF. BENDIX | TIPO / TYPE |
|---------------|-------------|-------------|
| 03.527014 | 286773 | E-7 |

DODGE



| Kit reparación / Repair kit | | | | |
|-----------------------------|-------------|-------------|---------------|-------------|
| REF. AIR-FREN | REF. BENDIX | TIPO / TYPE | REF. AIR-FREN | REF. BENDIX |
| 03.527009 | 286171 | E-6 | 03.R527009 | 287368 |



| Kit reparación / Repair kit | | | | |
|-----------------------------|-------------|-------------|---------------|-------------|
| REF. AIR-FREN | REF. BENDIX | TIPO / TYPE | REF. AIR-FREN | REF. BENDIX |
| 03.527010 | 286880 | E-6 | 03.R527010 | - |



| Kit reparación / Repair kit | | | | |
|-----------------------------|-------------|-------------|---------------|-------------|
| REF. AIR-FREN | REF. BENDIX | TIPO / TYPE | REF. AIR-FREN | REF. BENDIX |
| 03.527012 | 277863 | E-3 | 03.R527012 | - |



| REF. AIR-FREN | REF. WABCO |
|---------------|---------------|
| 03.527015 | 461.315.248.0 |

MERCEDES

| Kit reparación / Repair kit | |
|-----------------------------|---------------|
| REF. AIR-FREN | REF. WABCO |
| 03.R527015 | 461.315.920.2 |



| REF. AIR-FREN | REF. WABCO |
|---------------|---------------|
| 03.527016 | 461.315.258.0 |

DAF, MERCEDES

| Kit reparación / Repair kit | |
|-----------------------------|---------------|
| REF. AIR-FREN | REF. WABCO |
| 03.R527015 | 461.315.920.2 |



| REF. AIR-FREN | REF. WABCO |
|---------------|---------------|
| 03.527017 | 461.324.016.0 |

DAF, VOLVO

| Kit reparación / Repair kit | |
|-----------------------------|---------------|
| REF. AIR-FREN | REF. WABCO |
| 03.R627001 | 461.315.005.2 |
| 03.R527018 | 461.324.000.2 |



| REF. AIR-FREN | REF. WABCO |
|---------------|---------------|
| 03.527018 | 461.324.520.0 |

DAF, IVECO, MAN, RENAULT, VOLVO

| Kit reparación / Repair kit | |
|-----------------------------|---------------|
| REF. AIR-FREN | REF. WABCO |
| 03.R527018 | 461.324.000.2 |



| REF. AIR-FREN | REF. WABCO |
|---------------|---------------|
| 03.527021 | 461.319.271.0 |
| 03.527022 | 461.319.250.0 |

MERCEDES, DAF

| Kit reparación / Repair kit | |
|-----------------------------|---------------|
| REF. AIR-FREN | REF. WABCO |
| 03.R527021 | 461.319.006.2 |



| REF. AIR-FREN | REF. WABCO |
|---------------|---------------|
| 03.527023 | 461.319.260.0 |

MERCEDES, DAF

| Kit reparación / Repair kit | |
|-----------------------------|---------------|
| REF. AIR-FREN | REF. WABCO |
| 03.R527021 | 461.319.006.2 |



| REF. AIR-FREN | REF. KNORR |
|---------------|------------|
| 03.527019 | MB-4694 |



| REF. AIR-FREN | REF. KNORR | Kit reparación / Repair kit | |
|---------------|------------|-----------------------------|------------|
| REF. AIR-FREN | REF. KNORR | REF. AIR-FREN | REF. KNORR |
| 03.527020 | MB-4434 | 03.R527020 | I-72375 |



| REF. AIR-FREN | REF. BOSCH | Kit reparación / Repair kit | |
|---------------|------------|-----------------------------|------------|
| REF. AIR-FREN | REF. BOSCH | REF. AIR-FREN | REF. BOSCH |
| 03.527024 | 0481064206 | 03.R527024 | 1487010060 |



| REF. AIR-FREN | REF. WABCO |
|---------------|---------------|
| 03.527025 | 461.315.264.0 |

DAF, MERCEDES

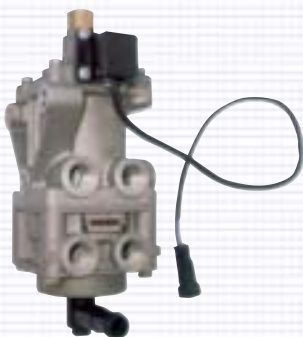

| REF. AIR-FREN | REF. KNORR | Kit reparación / Repair kit | |
|---------------|------------|-----------------------------|------------|
| REF. AIR-FREN | REF. KNORR | REF. AIR-FREN | REF. KNORR |
| 03.527026 | DX75BA | 03.R527026 | 76620102 |



REF. AIR-FREN

REF. KNORR

03.527028

DX75BAY



REF. AIR-FREN

REF. KNORR

03.527029

DX95B

04

VÁLVULAS FRENO DE MANO

HAND BRAKE VALVES



VÁLVULAS FRENO DE MANO / HAND BRAKE VALVES



| REF. AIR-FREN | REF. TACA |
|---------------|-----------|
| 04.240.724.0 | 240.724.0 |

IVECO, PEGASO

| Kit reparación / Repair kit | |
|-----------------------------|----------------|
| REF. AIR-FREN | REF. TACA |
| 04.R2400 | 240.724.01.100 |



| REF. AIR-FREN | REF. WABCO |
|---------------|------------|
| 04.240.726.0 | 420.041.7 |
| 04.240.726.7 | 420.042.6 |

IVECO, PEGASO

| Kit reparación / Repair kit | |
|-----------------------------|------------|
| REF. AIR-FREN | REF. WABCO |
| 04.R240.726.00 | 401.330.7 |
| 04.R240.726.00 | 401.330.7 |



| REF. AIR-FREN | REF. WABCO |
|---------------|------------|
| 04.240.726.1 | 420.086.4 |
| 04.240.726.9 | 420.100.1 |

IVECO, PEGASO

| Kit reparación / Repair kit | |
|-----------------------------|------------|
| REF. AIR-FREN | REF. WABCO |
| 04.R240.726.00 | 401.330.7 |
| 04.R240.726.00 | 401.330.7 |



| REF. AIR-FREN | REF. WABCO |
|---------------|------------|
| 04.240.726.3 | 420.074.3 |
| 04.240.726.5 | 420.061.3 |
| 04.240.726.6 | 420.094.9 |
| 04.240.726.8 | 420.064.0 |
| 04.240.726.17 | 420.070.7 |
| 04.240.726.18 | 420.231.4 |
| 04.240.726.19 | 420.046.2 |
| 04.240.726.20 | 420.233.2 |

RVI

| Kit reparación / Repair kit | |
|-----------------------------|------------|
| REF. AIR-FREN | REF. WABCO |
| 04.R240.726.00 | 401.330.7 |
| 04.R240.726.00 | 401.330.7 |
| 04.R240.726.00 | 401.330.7 |
| 04.R240.726.00 | 401.330.7 |
| 04.R240.726.00 | 401.330.7 |
| 04.R240.726.00 | 401.330.7 |
| 04.R240.726.00 | 401.330.7 |
| 04.R240.726.00 | 401.330.7 |

VALVULAS FRENO DE MANO / HAND BRAKE VALVES



| REF. AIR-FREN | REF. WABCO |
|---------------|------------|
| 04.240.726.4 | 420.080.0 |
| 04.240.726.10 | 420.102.9 |

| Kit reparación / Repair kit | |
|-----------------------------|------------|
| REF. AIR-FREN | REF. WABCO |
| 04.R240.726.41 | 402.098.3 |
| 04.R240.726.41 | 402.098.3 |

RVI



| REF. AIR-FREN | REF. WABCO |
|---------------|------------|
| 04.240.726.12 | 420.012.7 |
| 04.240.726.14 | 420.084.6 |
| 04.240.726.15 | 420.096.7 |
| 04.240.726.16 | 420.234.1 |

| Kit reparación / Repair kit | |
|-----------------------------|------------|
| REF. AIR-FREN | REF. WABCO |
| 04.R240.726.00 | 401.330.7 |
| 04.R240.726.00 | 401.330.7 |
| 04.R240.726.00 | 401.330.7 |
| 04.R240.726.00 | 401.330.7 |

IVECO, PEGASO



| REF. AIR-FREN | REF. WABCO | COLOR / COLOUR |
|-----------------|------------|----------------|
| 04.240.726.01.0 | 401.492.8 | Rojo / Red |
| 04.240.726.41.0 | 401.624.5 | Negro / Black |



| REF. AIR-FREN | REF. WABCO |
|---------------|---------------|
| 04.565590 | 961.722.302.0 |

| Kit reparación / Repair kit | |
|-----------------------------|---------------|
| REF. AIR-FREN | REF. WABCO |
| 04.R631009 | 961.722.003.2 |

MERCEDES, VOLVO, IVECO

VÁLVULAS FRENO DE MANO / HAND BRAKE VALVES



| REF. AIR-FREN | REF. WABCO |
|---------------|---|
| 04.240.726.21 | 961.721.004.0 961.721.044.0 961.721.033.0 |

DAF, SCANIA, IVECO, VOLVO, MAN



| REF. AIR-FREN | REF. WABCO |
|---------------|---------------|
| 04.240.726.22 | 961.721.017.0 |

RENAULT



| REF. AIR-FREN | REF. WABCO |
|---------------|---------------|
| 04.240.726.23 | 961.721.002.0 |

MAN, IVECO, VOLVO



| REF. AIR-FREN | REF. WABCO |
|---------------|---------------|
| 04.240.726.24 | 961.721.019.0 |

DAF, IVECO



| REF. AIR-FREN | REF. WABCO |
|---------------|---------------|
| 04.240.726.25 | 961.721.116.0 |

RENAULT

VALVULAS FRENO DE MANO / HAND BRAKE VALVES



| REF. AIR-FREN | REF. WABCO |
|---------------|---------------|
| 04.240.726.26 | 961.721.122.0 |

DAF, RENAULT



| REF. AIR-FREN | REF. WABCO |
|---------------|---------------|
| 04.240.726.27 | 961.721.021.0 |

RENAULT



| REF. AIR-FREN | REF. WABCO |
|---------------|---------------|
| 04.240.726.28 | 961.721.023.0 |

IVECO



| REF. AIR-FREN | REF. WABCO |
|---------------|---------------|
| 04.240.726.29 | 961.721.027.0 |

IVECO



| REF. AIR-FREN | REF. WABCO |
|---------------|---------------|
| 04.240.726.31 | 961.721.125.0 |

DAF, RENAULT

VÁLVULAS FRENO DE MANO / HAND BRAKE VALVES



| Kit reparación / Repair kit | | | |
|-----------------------------|------------|---------------|------------|
| REF. AIR-FREN | REF. KNORR | REF. AIR-FREN | REF. KNORR |
| 04.4100.00 | HB-1176 | 04.R4100 | I-72371 |

MAN, MERCEDES, MAGIRUS, VOLVO, IVECO



| Kit reparación / Repair kit | | | |
|-----------------------------|--------------------------------|---------------|---------------|
| REF. AIR-FREN | REF. WABCO | REF. AIR-FREN | REF. WABCO |
| 04.4211.00 04.4211.10 | 961.703.001.0 961.702.001.0 | 04.R631003 | 961.703.000.2 |

MAN, MERCEDES, DAF, IVECO



| Kit reparación / Repair kit | | | |
|-----------------------------|---------------|---------------|---------------|
| REF. AIR-FREN | REF. WABCO | REF. AIR-FREN | REF. WABCO |
| 04.4212.00 | 961.701.100.0 | 04.R4212 | 961.701.000.2 |

DAF, VOLVO, MAN



| Kit reparación / Repair kit | | | |
|-----------------------------|--------------------------------|---------------|---------------|
| REF. AIR-FREN | REF. WABCO | REF. AIR-FREN | REF. WABCO |
| 04.4213.00 | 961.723.004.0 961.723.016.0 | 04.R4213 | 961.723.001.2 |

DAF, MAN, RVI

VALVULAS FRENO DE MANO / HAND BRAKE VALVES



| REF. AIR-FREN | REF. WABCO |
|---------------|---|
| 04.4214.00 | 961.723.111.0 961.723.108.0 961.723.102.0 |

DAF

| Kit reparación / Repair kit | |
|-----------------------------|---------------|
| REF. AIR-FREN | REF. WABCO |
| 04.R4214 | 961.723.000.2 |



| REF. AIR-FREN | REF. WABCO |
|---------------|---------------|
| 04.4215.00 | 961.723.104.0 |

MERCEDES

| Kit reparación / Repair kit | |
|-----------------------------|---------------|
| REF. AIR-FREN | REF. WABCO |
| 04.R4214 | 961.723.000.2 |



| REF. AIR-FREN | REF. WABCO |
|---------------|---------------|
| 04.4216.00 | 961.723.118.0 |

MAN

| Kit reparación / Repair kit | |
|-----------------------------|---------------|
| REF. AIR-FREN | REF. WABCO |
| 04.R4214 | 961.723.000.2 |



| REF. AIR-FREN | REF. WABCO |
|---------------|---------------|
| 04.4239.00 | 961.723.019.0 |

MAN

| Kit reparación / Repair kit | |
|-----------------------------|---------------|
| REF. AIR-FREN | REF. WABCO |
| 04.R4214 | 961.723.000.2 |



| REF. AIR-FREN | REF. WABCO |
|---------------|---------------|
| 04.4217.00 | 961.722.305.0 |

VOLVO

| Kit reparación / Repair kit | |
|-----------------------------|---------------|
| REF. AIR-FREN | REF. WABCO |
| 04.R631009 | 961.722.003.2 |

VÁLVULAS FRENO DE MANO / HAND BRAKE VALVES



| REF. AIR-FREN | REF. WABCO |
|---------------|---------------|
| 04.4218.00 | 961.722.275.0 |

MERCEDES

Kit reparación / Repair kit

| REF. AIR-FREN | REF. WABCO |
|---------------|---------------|
| 04.R631010 | 961.722.004.2 |



| REF. AIR-FREN | REF. WABCO |
|---------------|---------------|
| 04.4219.00 | 961.722.258.0 |

IVECO

Kit reparación / Repair kit

| REF. AIR-FREN | REF. WABCO |
|---------------|---------------|
| 04.R631009 | 961.722.003.2 |



| REF. AIR-FREN | REF. WABCO |
|---------------|---------------|
| 04.4220.00 | 961.722.212.0 |

DAF, MERCEDES

Kit reparación / Repair kit

| REF. AIR-FREN | REF. WABCO |
|---------------|---------------|
| 04.R631010 | 961.722.004.2 |



| REF. AIR-FREN | REF. WABCO |
|---------------|---------------|
| 04.4228.00 | 961.722.232.0 |

MERCEDES

Kit reparación / Repair kit

| REF. AIR-FREN | REF. WABCO |
|---------------|---------------|
| 04.R631010 | 961.722.004.2 |



| REF. AIR-FREN | REF. WABCO |
|---------------|---------------|
| 04.4221.00 | 961.722.264.0 |

MERCEDES, RVI

Kit reparación / Repair kit

| REF. AIR-FREN | REF. WABCO |
|---------------|---------------|
| 04.R631010 | 961.722.004.2 |

VALVULAS FRENO DE MANO / HAND BRAKE VALVES



| REF. AIR-FREN | REF. WABCO |
|---------------|---------------|
| 04.4222.00 | 961.722.269.0 |

RENAULT

| Kit reparación / Repair kit | |
|-----------------------------|---------------|
| REF. AIR-FREN | REF. WABCO |
| 04.R631009 | 961.722.003.2 |



| REF. AIR-FREN | REF. WABCO |
|---------------|---------------|
| 04.4234.00 | 961.722.150.0 |

DAF, IVECO, MERCEDES, SCANIA

| Kit reparación / Repair kit | |
|-----------------------------|---------------|
| REF. AIR-FREN | REF. WABCO |
| 04.R631008 | 961.722.002.2 |



| REF. AIR-FREN | REF. WABCO |
|---------------|---------------|
| 04.4238.00 | 961.721.007.0 |

MAN

| Kit reparación / Repair kit | |
|-----------------------------|---------------|
| REF. AIR-FREN | REF. WABCO |
| 04.R4238 | 961.721.008.2 |



| REF. AIR-FREN | REF. WABCO |
|---------------|---------------|
| 04.4224.00 | 961.722.151.0 |
| 04.4224.50 | 961.722.152.0 |

MERCEDES

| Kit reparación / Repair kit | |
|-----------------------------|---------------|
| REF. AIR-FREN | REF. WABCO |
| 04.R631008 | 961.722.002.2 |

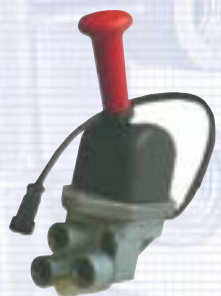

| REF. AIR-FREN | REF. KNORR |
|---------------|------------|
| 04.4236.00 | DPM94AAX |

IVECO

VÁLVULAS FRENO DE MANO / HAND BRAKE VALVES



REF. AIR-FREN

REF. WABCO

04.4225.00

961.722.252.0

MERCEDES, DAF



REF. AIR-FREN

REF. WABCO

04.4226.00

961.722.324.0

VOLVO



REF. AIR-FREN

REF. WABCO

04.4227.00

961.722.168.0

IVECO



REF. AIR-FREN

REF. WABCO

04.4229.00

961.723.107.0

MERCEDES



REF. AIR-FREN

REF. BENDIX

04.4230.00

KX-1130/4

04.4231.00

KX-2006/1

KX-1130/1

VALVULAS FRENO DE MANO / HAND BRAKE VALVES

REF. AIR-FREN
REF. NEWAY

04.4232.00

910058

REF. AIR-FREN
REF. NEWAY

04.4233.00

910014

REF. AIR-FREN
REF. HALDEX

04.4235.00

338 021 001

REF. AIR-FREN
REF. MIDLAND

04.3546.00

KN 3546

05



VÁLVULAS RELÉ

RELAY VALVES



| REF. AIR-FREN | REF. WABCO |
|---------------|---------------|
| 05.545003 | 973.001.010.0 |

| Kit reparación / Repair kit | |
|-----------------------------|---------------|
| REF. AIR-FREN | REF. WABCO |
| 05.R645002 | 973.001.000.2 |

MERCEDES, MAN, VOLVO, DAF, IVECO, RVI



| REF. AIR-FREN | REF. WABCO |
|---------------|---------------|
| 05.135517 | 973.001.020.0 |

| Kit reparación / Repair kit | |
|-----------------------------|---------------|
| REF. AIR-FREN | REF. WABCO |
| 05.R645002 | 973.001.000.2 |

MERCEDES, MAN, VOLVO, DAF, IVECO, RVI



| REF. AIR-FREN | REF. WABCO |
|---------------|---------------|
| 05.545004 | 973.011.001.0 |
| 05.545005 | 973.011.000.0 |

| Kit reparación / Repair kit | |
|-----------------------------|---------------|
| REF. AIR-FREN | REF. WABCO |
| 05.R5020 | 973.011.000.2 |
| 05.R5020 | 973.011.000.2 |

MERCEDES, MAN, VOLVO, DAF, IVECO, RVI



| REF. AIR-FREN | REF. WABCO |
|---------------|---------------|
| 05.545017 | 973.011.200.0 |

| Kit reparación / Repair kit | |
|-----------------------------|---------------|
| REF. AIR-FREN | REF. WABCO |
| 05.R5020 | 973.011.000.2 |

DAF, MAN, MERCEDES



| REF. AIR-FREN | REF. WABCO |
|---------------|---------------|
| 05.575537 | 473.017.000.0 |

| Kit reparación / Repair kit | |
|-----------------------------|---------------|
| REF. AIR-FREN | REF. WABCO |
| 05.R645013 | 473.017.000.2 |

MERCEDES, VOLVO, DAF, IVECO



| REF. AIR-FREN | REF. BOSCH |
|---------------|------------|
| 05.545006 | 0481026027 |

SCANIA



| REF. AIR-FREN | REF. WABCO |
|---------------|---------------|
| 05.545021 | 973.006.001.0 |
| 05.545023 | 973.006.000.0 |

DAF, MAN, MERCEDES, RVI



| REF. AIR-FREN | REF. WABCO |
|---------------|---------------|
| 05.545022 | 973.006.003.0 |

MAN, MERCEDES



| REF. AIR-FREN | REF. WABCO |
|---------------|---------------|
| 05.9710.00 | 971.002.152.0 |

DAF, SEMIRREMOLQUE

| Kit reparación / Repair kit | |
|-----------------------------|---------------|
| REF. AIR-FREN | REF. WABCO |
| 05.R9710 | 971.002.004.2 |



| REF. AIR-FREN | REF. GRAU |
|---------------|-----------|
| 05.30300 | KN-30300 |

FRUEHAUF

| Kit reparación / Repair kit | |
|-----------------------------|-------------|
| REF. AIR-FREN | REF. GRAU |
| 05.R035004 | 950.035.004 |



| REF. AIR-FREN | REF. BENDIX |
|---------------|-------------|
| 05.3300.34* | 280.375 |
| | 114.031 |
| 05.3300.44** | 114.021 |

VOLVO, SCANIA, IVECO

* Bocas / Ports: Pulgadas / Inches

** Bocas / Ports: Métrica / Metrical

| Kit reparación / Repair kit | |
|-----------------------------|-------------|
| REF. AIR-FREN | REF. BENDIX |
| 05.R645003 | 364.013 |
| 05.R645003 | 364.013 |



| REF. AIR-FREN | REF. BENDIX |
|---------------|-------------|
| 05.7558.00 | 281672 |

MERCEDES, MAN, DAF, VOLVO, SCANIA, M.O.P.

| Kit reparación / Repair kit | |
|-----------------------------|-------------|
| REF. AIR-FREN | REF. BENDIX |
| 05.R645004 | 266784 |



| REF. AIR-FREN | REF. WABCO |
|---------------|---------------|
| 05.235546 | 971.002.150.0 |

| Kit reparación / Repair kit | |
|-----------------------------|---------------|
| REF. AIR-FREN | REF. WABCO |
| 05.R645010 | 971.002.003.2 |

SEMIRREMOLQUES



| Regulador 3 posiciones / Regulator 3 positions | |
|--|---------------|
| REF. AIR-FREN | REF. WABCO |
| 05.605733 | 475.604.013.0 |
| 05.605734* | 475.604.011.0 |

| Kit reparación / Repair kit | |
|-----------------------------|---------------|
| REF. AIR-FREN | REF. WABCO |
| 05.R5090 | 475.604.002.2 |

SEMIRREMOLQUES (*) 4 posiciones



Válvula de afloje / Trailer release valve

| REF. AIR-FREN | REF. WABCO |
|---------------|---------------|
| 05.2458.49 | 963.001.001.0 |

SEMIRREMOLQUES



| REF. AIR-FREN | REF. WABCO |
|---------------|---------------|
| 05.2750.70 | 971.002.531.0 |

SEMIRREMOLQUES



| REF. AIR-FREN | REF. WABCO | POSITION |
|---------------|---------------|--------------------------|
| 05.2750.60 | 971.002.570.0 | 4 posiciones / positions |
| 05.2750.80 | 461.233.1 | 3 posiciones / positions |

SEMIRREMOLQUES

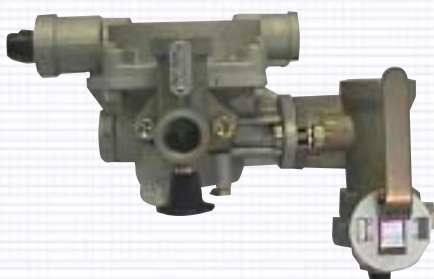

| REF. AIR-FREN | REF. WABCO |
|---------------|------------|
| 05.2750.90 | 461.234.0 |

SEMIRREMOLQUES



REF. AIR-FREN

05.557007

REF. WABCO

971.002.000.0

Kit reparación / Repair kit

REF. AIR-FREN

05.R557007

REF. WABCO

971.002.006.2

DAF, IVECO, RENAULT, VOLVO



REF. AIR-FREN

05.2458.50

REF. WABCO

963.006.001.0

DAF, IVECO, RENAULT



REF. AIR-FREN

05.2458.51

REF. WABCO

963.001.013.0

DAF, MAN, RENAULT



REF. AIR-FREN

05.3520.18

REF. GRAU

352 018 001

SEMIRREMOLQUES



REF. AIR-FREN

05.3520.19

REF. GRAU

352 019 001

SEMIRREMOLQUES



| REF. AIR-FREN | REF. WABCO |
|---------------|---------------|
| 05.557004 | 973.002.000.0 |

| Kit reparación / Repair kit | |
|-----------------------------|---------------|
| REF. AIR-FREN | REF. WABCO |
| 05.R657000 | 973.002.003.2 |

MERCEDES, MAN, DAF, VOLVO

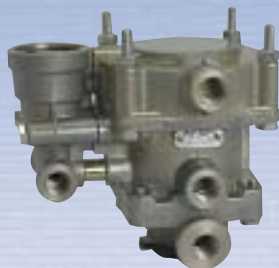

| REF. AIR-FREN | REF. WABCO |
|---------------|---------------|
| 05.557002 | 973.002.520.0 |
| 05.557001 | 973.002.521.0 |

| Kit reparación / Repair kit | |
|-----------------------------|---------------|
| REF. AIR-FREN | REF. WABCO |
| 05.R657001 | 973.002.006.2 |
| 05.R657002 | 973.002.005.2 |

MERCEDES, VOLVO, IVECO



| REF. AIR-FREN | REF. WABCO |
|---------------|---------------|
| 05.008000 | 973.008.002.0 |

| Kit reparación / Repair kit | |
|-----------------------------|---------------|
| REF. AIR-FREN | REF. WABCO |
| 05.R008000 | 973.008.001.2 |

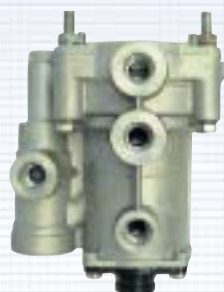

| REF. AIR-FREN | REF. WABCO |
|---------------|--------------------------------|
| 05.009000 | 973.009.000.0 973.009.001.0 |

| Kit reparación / Repair kit | |
|-----------------------------|---------------|
| REF. AIR-FREN | REF. WABCO |
| 05.R009000 | 973.009.000.2 |

MERCEDES

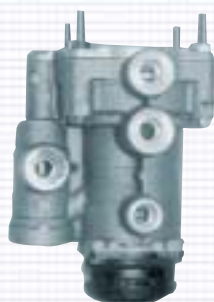

| REF. AIR-FREN | REF. WABCO |
|---------------|---------------|
| 05.009010 | 973.009.010.0 |

| Kit reparación / Repair kit | |
|-----------------------------|---------------|
| REF. AIR-FREN | REF. WABCO |
| 05.R009000 | 973.009.000.2 |

SCANIA

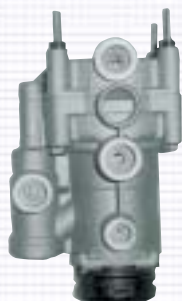

| REF. AIR-FREN | REF. WABCO |
|---------------|---------------|
| 05.009300 | 973.009.300.0 |

| Kit reparación / Repair kit | |
|-----------------------------|---------------|
| REF. AIR-FREN | REF. WABCO |
| 05.R009300 | 973.009.001.2 |

DAF



| REF. AIR-FREN | REF. WABCO |
|---------------|---------------|
| 05.533001 | 475.710.020.0 |

MERCEDES, VOLVO, DAF, MAN, SCANIA, IVECO

| Kit reparación / Repair kit | |
|-----------------------------|---------------|
| REF. AIR-FREN | REF. WABCO |
| 05.R633001 | 475.710.001.2 |



| REF. AIR-FREN | REF. WABCO |
|---------------|---------------|
| 05.533005 | 475.710.024.0 |

IVECO, RENAULT, DAF

| Kit reparación / Repair kit | |
|-----------------------------|---------------|
| REF. AIR-FREN | REF. WABCO |
| 05.R633001 | 475.710.001.2 |



| REF. AIR-FREN | REF. WABCO |
|---------------|---------------|
| 05.533010 | 475.710.136.0 |

SEMIRREMOLQUES

| Kit reparación / Repair kit | |
|-----------------------------|---------------|
| REF. AIR-FREN | REF. WABCO |
| 05.R633001 | 475.710.001.2 |



| REF. AIR-FREN | REF. WABCO |
|---------------|---------------|
| 05.715000 | 475.715.500.0 |

SEMIRREMOLQUES

| Kit reparación / Repair kit | |
|-----------------------------|---------------|
| REF. AIR-FREN | REF. WABCO |
| 05.R715000 | 475.715.000.2 |



| REF. AIR-FREN | REF. WABCO |
|---------------|---------------|
| 05.712000 | 475.712.000.0 |

SEMIRREMOLQUES

| Kit reparación / Repair kit | |
|-----------------------------|---------------|
| REF. AIR-FREN | REF. WABCO |
| 05.R712000 | 475.712.000.2 |

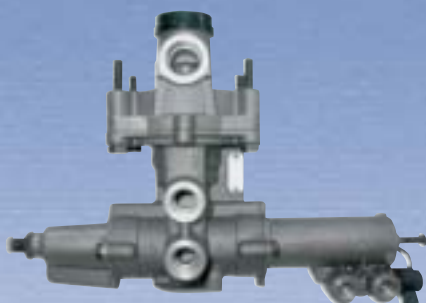

| REF. AIR-FREN | REF. WABCO |
|---------------|---------------|
| 05.714000 | 475.714.500.0 |

| Kit reparación / Repair kit | |
|-----------------------------|---------------|
| REF. AIR-FREN | REF. WABCO |
| 05R714000 | 475.714.000.2 |

DAF, MERCEDES, EVO BUS



| REF. AIR-FREN | REF. WABCO |
|---------------|--------------------------------|
| 05.711000 | 475.711.000.0 475.711.075.0 |

| Kit reparación / Repair kit | |
|-----------------------------|---------------|
| REF. AIR-FREN | REF. WABCO |
| 05.R711000 | 475.711.000.2 |

MERCEDES, DAF, VOLVO, RVI



| REF. AIR-FREN | REF. WABCO |
|---------------|---------------|
| 05.700000 | 475.700.403.0 |

| Kit reparación / Repair kit | |
|-----------------------------|---------------|
| REF. AIR-FREN | REF. WABCO |
| 05.R700403 | 475.700.004.2 |

DAF, IVECO, MAN, RENAULT



| REF. AIR-FREN | REF. WABCO | α |
|---------------|---------------|-----|
| 05.6120.40 | 475.701.001.0 | 30° |
| 05.6120.50 | 475.701.020.0 | 15° |

MAN, MERCEDES, DAF, VOLVO, SCANIA, IVECO, RVI



| REF. AIR-FREN | REF. GRAU |
|---------------|-----------|
| 05.7558.50 | KN-30300 |

| Kit reparación / Repair kit | |
|-----------------------------|--|
| REF. AIR-FREN | |
| 05.R645004 | |

MODELO BENDIX INTERCAMBIABLE CON GRAU
Type Bendix exchanged with type Grau
FRUEHAUF



| REF. AIR-FREN | REF. WABCO |
|---------------|---------------|
| 05.557005 | 471.005.020.0 |

| Kit reparación / Repair kit | |
|-----------------------------|---------------|
| REF. AIR-FREN | REF. WABCO |
| 05.R557005 | 471.005.009.2 |

DAF



| REF. AIR-FREN | REF. WABCO |
|---------------|---------------|
| 05.557006 | 971.002.300.0 |

| Kit reparación / Repair kit | |
|-----------------------------|---------------|
| REF. AIR-FREN | REF. WABCO |
| 05.R557006 | 971.002.008.2 |



| REF. AIR-FREN | REF. BENDIX | MODELO / MODEL |
|---------------|------------------|----------------|
| 05.545018 | 286370 286371 | R-8 |



| REF. AIR-FREN | REF. MIDLAND | MODELO / MODEL |
|------------------------|----------------------|----------------|
| 05.545012 05.545013 | KN-28520 KN-28500 | RG-2 |



| REF. AIR-FREN | REF. BENDIX | MODELO / MODEL |
|---------------|-------------|----------------|
| 05.545019 | 287114 | R-8P |



| REF. AIR-FREN | REF. SEALCO |
|---------------|-------------|
| 05.545014 | 110200 |



| REF. AIR-FREN | REF. MIDLAND | MODELO / MODEL |
|---------------|--------------|----------------|
| 05.545020 | KN-28550 | RG-5 |



| REF. AIR-FREN | REF. BENDIX | MODELO / MODEL |
|--------------------------|------------------|----------------|
| 05.0651.00 05.0651.10 | 065145 065146 | BP-R1 |



| REF. AIR-FREN | REF. BENDIX | MODELO / MODEL |
|---------------|-------------|----------------|
| 05.0654.00 | 065437 | SR-5 |



| REF. AIR-FREN | REF. BENDIX | MODELO / MODEL |
|--------------------------|------------------|----------------|
| 05.1011.00 05.1011.10 | 101112 101622 | SR-4 |



| REF. AIR-FREN | REF. MIDLAND | MODELO / MODEL |
|--------------------------|----------------------|----------------|
| 05.2860.00 05.2860.10 | KN 28600 KN 28601 | FF-2 |



| REF. AIR-FREN | REF. BENDIX | MODELO / MODEL |
|---------------|-------------|----------------|
| 05.2863.00 | 286364 | SR-1 |



| REF. AIR-FREN | REF. MIDLAND | MODELO / MODEL |
|---------------|--------------|----------------|
| 05.545016 | KN 28060 | R-5 |



| REF. AIR-FREN | REF. BENDIX |
|---------------|-------------|
| 05.545007 | 103009 |

Modelo / Model R-12

| Kit reparación / Repair kit | |
|-----------------------------|-------------|
| REF. AIR-FREN | REF. BENDIX |
| 05.R545007 | - |



| REF. AIR-FREN | REF. BENDIX |
|---------------|------------------|
| 05.545008 | 102626 102166 |

Modelo / Model R-12

| Kit reparación / Repair kit | |
|-----------------------------|-------------|
| REF. AIR-FREN | REF. BENDIX |
| 05.R545007 | - |



| REF. AIR-FREN | REF. BENDIX |
|---------------|-------------|
| 05.545009 | 103028 |

Modelo / Model R-14

| Kit reparación / Repair kit | |
|-----------------------------|-------------|
| REF. AIR-FREN | REF. BENDIX |
| 05.R545009 | - |

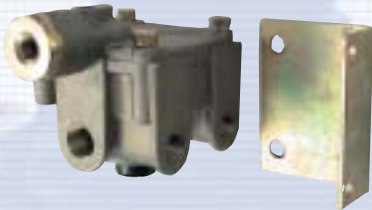

| REF. AIR-FREN | REF. BENDIX |
|---------------|-------------|
| 05.545010 | 103010 |

Modelo / Model R-14

| Kit reparación / Repair kit | |
|-----------------------------|-------------|
| REF. AIR-FREN | REF. BENDIX |
| 05.R545009 | - |

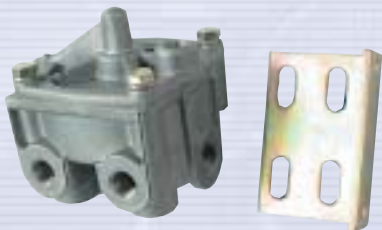

| REF. AIR-FREN | REF. BENDIX |
|---------------|------------------|
| 05.545011 | 065476 109264 |

Modelo / Model R-12P

| Kit reparación / Repair kit | |
|-----------------------------|-------------|
| REF. AIR-FREN | REF. BENDIX |
| 05.R545011 | 109265 |



| REF. AIR-FREN | REF. SEALCO |
|---------------|-------------|
| 05.545015 | A-1000 |

| Kit reparación / Repair kit | |
|-----------------------------|-------------|
| REF. AIR-FREN | REF. SEALCO |
| 05.R545015 | - |



| REF. AIR-FREN | REF. GRAU |
|---------------|-------------|
| 05.2440.12 | 351.012.001 |

| Kit reparación / Repair kit | |
|-----------------------------|-------------|
| REF. AIR-FREN | REF. GRAU |
| 05.R7000 | 950.351.005 |

LECIÑENA, FRUEHAUF



| REF. AIR-FREN | REF. GRAU |
|---------------|-------------|
| 05.2440.14 | 351.014.001 |

LECIÑENA, FRUEHAUF

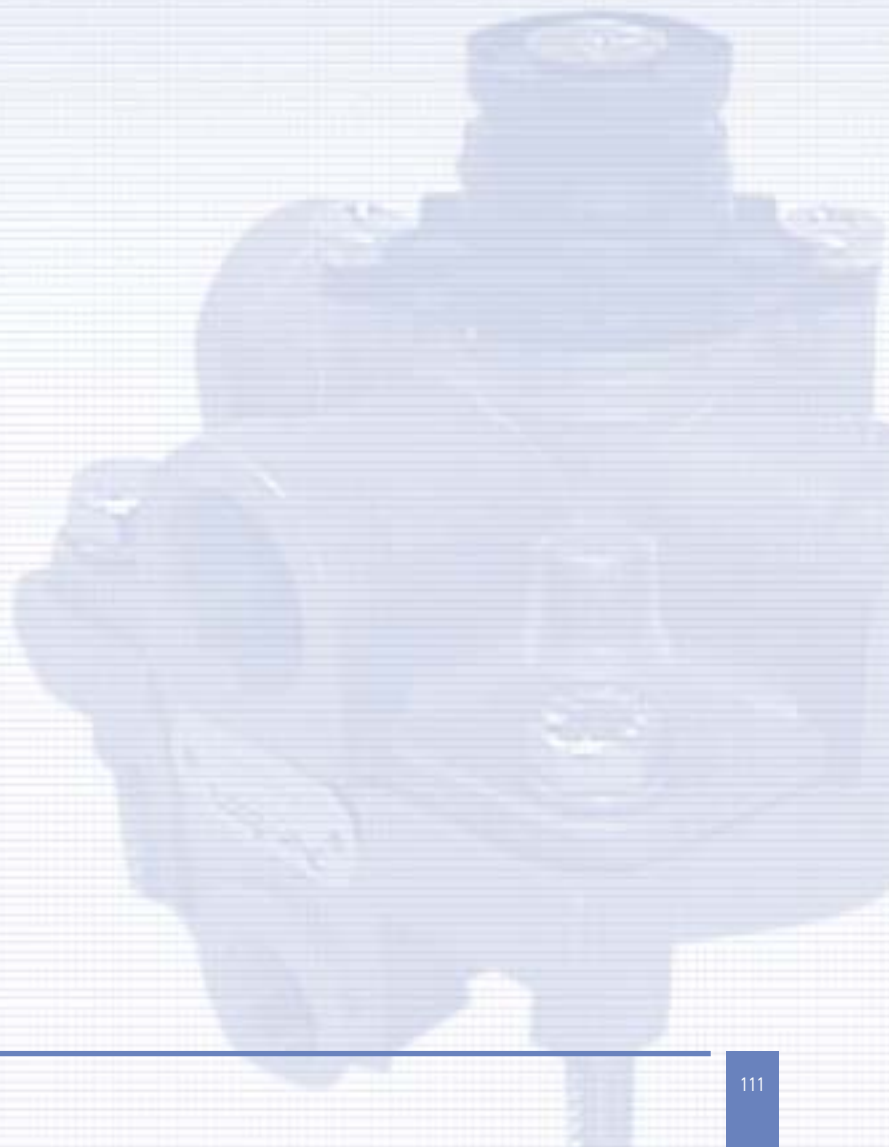

06



VÁLVULAS
PROTECCIÓN CIRCUITO
CIRCUIT PROTECTION VALVES

VÁLVULAS PROTECCIÓN CIRCUITO / CIRCUIT PROTECTION VALVES



| REF. AIR-FREN | REF. WABCO |
|---------------|---------------|
| 06.539110 | 934.702.320.0 |

| Kit reparación / Repair kit | |
|-----------------------------|---------------|
| REF. AIR-FREN | REF. WABCO |
| 06.R639008 | 934.702.001.2 |

MAN, MERCEDES, DAF, VOLVO, SCANIA, RVI, IVECO, PEGASO



| REF. AIR-FREN | REF. WABCO |
|---------------|---------------|
| 06.645.526 | 934.701.000.0 |

| Kit reparación / Repair kit | |
|-----------------------------|---------------|
| REF. AIR-FREN | REF. WABCO |
| 06.R639007 | 934.701.000.2 |

MERCEDES, IVECO, PEGASO

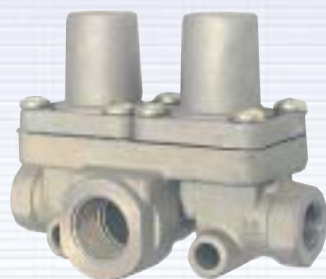

| REF. AIR-FREN | REF. WABCO |
|---------------|---------------|
| 06.559160 | 934.700.040.0 |

MERCEDES, RENAULT, MAN



| REF. AIR-FREN | REF. WABCO |
|---------------|---------------|
| 06.559110 | 934.702.221.0 |

| Kit reparación / Repair kit | |
|-----------------------------|---------------|
| REF. AIR-FREN | REF. WABCO |
| 06.R659008 | 934.702.005.2 |

MAN, MERCEDES, DAF, VOLVO, SCANIA



| REF. AIR-FREN | REF. WABCO |
|---------------|---------------|
| 06.559120 | 934.702.250.0 |

| Kit reparación / Repair kit | |
|-----------------------------|---------------|
| REF. AIR-FREN | REF. WABCO |
| 06.R559120 | 934.901.005.2 |

DAF, IVECO, MERCEDES

VALVULAS PROTECCIÓN CIRCUITO /

CIRCUIT PROTECTION VALVES



| REF. AIR-FREN | REF. WABCO |
|---------------|---------------|
| 06.559150 | 934.705.002.0 |

MERCEDES: sin sensor de presión / without pressure sensor



| REF. AIR-FREN | REF. WABCO |
|---------------|---------------|
| 06.559130 | 934.714.010.0 |

Kit reparación / Repair kit

| REF. AIR-FREN | REF. WABCO |
|---------------|------------|
| 06.R559130 | - |

MAN



| REF. AIR-FREN | REF. KNORR |
|---------------|------------|
| 06.569110 | AE-4183 |

Kit reparación / Repair kit

| REF. AIR-FREN | REF. KNORR |
|---------------|------------|
| 06.R6040 | I-78183 |

MERCEDES, MAN



| REF. AIR-FREN | REF. KNORR |
|---------------|------------|
| 06.579110 | AE-4604 |



VOLVO FH12



| REF. AIR-FREN | REF. KNORR |
|---------------|------------|
| 06.6050.60 | AE-4170 |

Kit reparación / Repair kit

| REF. AIR-FREN | REF. KNORR |
|---------------|------------|
| 06.R6050 | I-81171 |

RVI, MERCEDES, VOLVO, DAF, MAN, SCANIA, IVECO

VÁLVULAS PROTECCIÓN CIRCUITO / CIRCUIT PROTECTION VALVES



| REF. AIR-FREN | REF. KNORR |
|---------------|------------|
| 06.4440.00 | AE-4440 |

RVI



| Kit reparación / Repair kit | | | |
|-----------------------------|------------|---------------|--------------|
| REF. AIR-FREN | REF. KNORR | REF. AIR-FREN | REF. KNORR |
| 06.4510.00 | AE-4510 | 06.R4510 | II-37680/008 |

MERCEDES



| REF. AIR-FREN | REF. KNORR |
|---------------|------------|
| 06.4437.00 | AE-4437 |

DAF

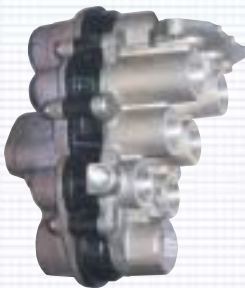

| REF. AIR-FREN | REF. KNORR |
|---------------|------------|
| 06.4502.00 | AE-4502 |

IVECO



| REF. AIR-FREN | REF. KNORR |
|---------------|------------|
| 06.4605.00 | AE-4605 |

RENAULT

VALVULAS PROTECCIÓN CIRCUITO / CIRCUIT PROTECTION VALVES

REF. AIR-FREN

06.4528.00

REF. KNORR

AE-4528

Kit reparación / Repair kit
REF. AIR-FREN

06.R4528

REF. KNORR

II-39746

DAF

REF. AIR-FREN

06.4516.00

REF. KNORR

AE-4516

IVECO STRALIS

07



**REGULADORES
DE PRESIÓN**
UNLOADER VALVES



| | | | Kit reparación / Repair kit | |
|---------------|---------------|----------------|-----------------------------|---------------|
| REF. AIR-FREN | REF. WABCO | PRESSION (BAR) | REF. AIR-FREN | REF. WABCO |
| 07.561001 | 975.303.473.0 | 8,1 | 07.R661004 | 975.303.001.2 |
| 07.561005 | 975.303.060.0 | 8,1 | 07.R661004 | 975.303.001.2 |
| 07.561006 | 975.303.081.0 | 9,5 | 07.R661004 | 975.303.001.2 |
| 07.561007 | 975.303.447.0 | 7,3 | 07.R661004 | 975.303.001.2 |

Para V/Anticongelante/For V/Anti-Freeze
 MERCEDES, MAN, MAGIRUS, RVI, IVECO, PEGASO



| | | | Kit reparación / Repair kit | |
|---------------|---------------|----------------|-----------------------------|---------------|
| REF. AIR-FREN | REF. WABCO | PRESSION (BAR) | REF. AIR-FREN | REF. WABCO |
| 07.561008 | 975.303.061.0 | 8,1 | 07.R661004 | 975.303.001.2 |
| 07.561002 | 975.303.474.0 | 8,1 | 07.R661004 | 975.303.001.2 |
| 07.561009 | 975.303.504.0 | 10,0 | 07.R661004 | 975.303.001.2 |

Para V/Secadora/For Air Dryer
 RVI, MERCEDES, DAF, MAN, IVECO



| | | | Kit reparación / Repair kit | |
|---------------|---------------|----------------|-----------------------------|---------------|
| REF. AIR-FREN | REF. WABCO | PRESSION (BAR) | REF. AIR-FREN | REF. WABCO |
| 07.7020.80 | 975.303.084.0 | 9,5 | 07.R661004 | 975.303.001.2 |
| 07.7020.90 | 975.303.478.0 | 8,1 | 07.R661004 | 975.303.001.2 |

RVI, IVECO, MAN, MERCEDES



| REF. AIR-FREN | REF. WABCO | PRESION (BAR) |
|---------------|---------------|---------------|
| 07.561010 | 975.303.541.0 | 12,0 |

| Kit reparación / Repair kit | |
|-----------------------------|---------------|
| REF. AIR-FREN | REF. WABCO |
| 07.R661003 | 975.303.000.2 |

MERCEDES



| REF. AIR-FREN | REF. WABCO | PRESION (BAR) |
|---------------|---------------|---------------|
| 07.561011 | 975.303.120.0 | 11,0 |

| Kit reparación / Repair kit | |
|-----------------------------|---------------|
| REF. AIR-FREN | REF. WABCO |
| 07.R661003 | 975.303.000.2 |

IVECO



| REF. AIR-FREN | REF. WABCO | PRESION (BAR) |
|---------------|---------------|---------------|
| 07.7020.60 | 975.303.140.0 | 12,5 |

| Kit reparación / Repair kit | |
|-----------------------------|---------------|
| REF. AIR-FREN | REF. WABCO |
| 07.R661003 | 975.303.000.2 |

MAN



| REF. AIR-FREN | REF. WABCO | PRESION (BAR) |
|---------------|---------------|---------------|
| 07.7020.70 | 975.303.220.0 | 16,0 |

| Kit reparación / Repair kit | |
|-----------------------------|---------------|
| REF. AIR-FREN | REF. WABCO |
| 07.R661003 | 975.303.000.2 |

DAF, IVECO, MAN



| REF. AIR-FREN | REF. WABCO | PRESION (BAR) |
|---------------|---------------|---------------|
| 07.045522 | 975.300.110.0 | 8,1 |
| 07.055522 | 975.300.111.0 | 7,3 |
| 07.065522 | 975.300.112.0 | 7,8 |

Kit reparación / Repair kit

| REF. AIR-FREN | REF. WABCO |
|---------------|---------------|
| 07.R661001 | 975.300.000.2 |
| 07.R661001 | 975.300.000.2 |
| 07.R661001 | 975.300.000.2 |

MERCEDES, MAN, IVECO, PEGASO, RVI



| REF. AIR-FREN | REF. KNORR | PRESION (BAR) |
|---------------|------------|---------------|
| 07.015467 | DR-3200 | 8,1 |

Kit reparación / Repair kit

| REF. AIR-FREN | REF. KNORR |
|---------------|------------|
| 07.R920467 | I-61090 |

MAN, MERCEDES, RVI

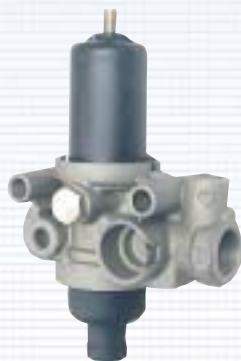

| REF. AIR-FREN | REF. KNORR | PRESION (BAR) |
|---------------|------------|---------------|
| 07.3515.00 | DR-3515 | 9,5 |

IVECO, RVI



| REF. AIR-FREN | REF. WABCO | PRESION (BAR) |
|---------------|---------------|---------------|
| 07.561003 | 475.304.201.0 | 8,1 |

Kit reparación / Repair kit

| REF. AIR-FREN | REF. WABCO |
|---------------|---------------|
| 07.R661005 | 475.304.009.2 |

MAN, MERCEDES, IVECO



Kit reparación / Repair kit

| REF. AIR-FREN | REF. PEGASO | REF. AIR-FREN |
|---------------|-------------|---------------|
| 07.3600.00 | 556.659 | 07.R3600 |

IVECO, PEGASO



Kit reparación / Repair kit

| REF. AIR-FREN | REF. BENDIX | REF. AIR-FREN | REF. BENDIX |
|---------------|-------------|---------------|-------------|
| 07.529001 | 275508 | 07.R629002 | SK-2612 / 1 |

VOLVO, SCANIA

7,3 bar



| REF. AIR-FREN | REF. BENDIX |
|---------------|-------------|
| 07.7070.20 | 272126 |

VOLVO

12,5 bar



| REF. AIR-FREN | REF. WABCO |
|---------------|---------------|
| 07.1335.00 | 133.527.920.8 |

| Kit reparación / Repair kit | |
|-----------------------------|---------------|
| REF. AIR-FREN | REF. WABCO |
| 07.R1335 | 720.199.000.8 |

RENAULT



| REF. AIR-FREN | REF. TACA |
|---------------|-----------|
| 07.3500.30 | 245.001.3 |
| 07.3500.60 | 245.001.6 |

| Kit reparación / Repair kit | |
|-----------------------------|----------------|
| REF. AIR-FREN | REF. TACA |
| 07.R3500 | 245.001.11.100 |
| 07.R3500 | 245.001.11.100 |

RVI



| REF. AIR-FREN | REF. TACA |
|---------------|-----------|
| 07.3550.20 | 245.003.2 |

| Kit reparación / Repair kit | |
|-----------------------------|----------------|
| REF. AIR-FREN | REF. TACA |
| 07.R3550 | 245.003.01.100 |

RVI

08

VÁLVULAS NIVELADORAS

LEVEL VALVES



VÁLVULAS NIVELADORAS / LEVEL VALVES



| Kit reparación / Repair kit | | | |
|-----------------------------|---------------|---------------|---------------|
| REF. AIR-FREN | REF. WABCO | REF. AIR-FREN | REF. WABCO |
| 08.933.492 | 464.002.330.0 | 08.R464002 | 464.002.008.2 |
| | | 08.R464003 | 464.002.005.2 |

MERCEDES, VOLVO, DAF, SCANIA, IVECO, PEGASO



| Kit reparación / Repair kit | | | |
|-----------------------------|---------------|---------------|---------------|
| REF. AIR-FREN | REF. WABCO | REF. AIR-FREN | REF. WABCO |
| 08.222.703 | 464.002.332.0 | 08.R464002 | 464.002.008.2 |
| | | 08.R464003 | 464.002.005.2 |

MAN, MERCEDES, IVECO, PEGASO



| REF. AIR-FREN | REF. WABCO |
|---------------|---------------|
| 08.4640.00 | 464.004.000.0 |

IVECO



| Kit reparación / Repair kit | | | |
|-----------------------------|---------------|---------------|---------------|
| REF. AIR-FREN | REF. WABCO | REF. AIR-FREN | REF. WABCO |
| 08.8010.30 | 464.006.000.0 | 08.R8015 | 464.006.000.2 |

VOLVO



| REF. AIR-FREN | REF. WABCO |
|---------------|--------------------------------|
| 08.8010.40 | 464.006.002.0 464.006.001.0 |

| Kit reparación / Repair kit | |
|-----------------------------|---------------|
| REF. AIR-FREN | REF. WABCO |
| 08.R8015 | 464.006.000.2 |

BPW, MAN

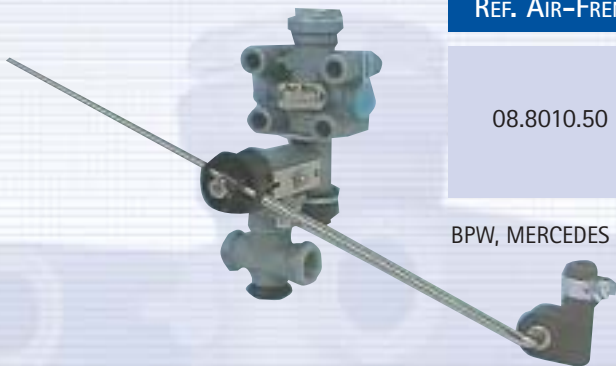

| REF. AIR-FREN | REF. WABCO |
|---------------|---------------|
| 08.8010.50 | 464.006.100.0 |

| Kit reparación / Repair kit | |
|-----------------------------|---------------|
| REF. AIR-FREN | REF. WABCO |
| 08.R8016 | 464.006.001.2 |

BPW, MERCEDES



| Válvula control de altura / Control valve | |
|---|---------------|
| REF. AIR-FREN | REF. WABCO |
| 08.3032.00 | 463.032.020.0 |

| Kit reparación / Repair kit | |
|-----------------------------|---------------|
| REF. AIR-FREN | REF. WABCO |
| 08.R3032 | 463.032.001.2 |

DAF, MERCEDES, IVECO, VOLVO, MAN



| REF. AIR-FREN | REF. WABCO | CONECTOR |
|---------------|---------------|----------|
| 08.4410.50 | 441.050.011.0 | Bayoneta |

DAF, MAN IVECO, MERCEDES, SCANIA



| REF. AIR-FREN | REF. WABCO | CONECTOR |
|---------------|---------------|--------------|
| 08.4410.60 | 441.050.010.0 | Métrica; M26 |

DAF, RVI, VOLVO



| REF. AIR-FREN | REF. WABCO | CONECTOR |
|---------------|---------------|--------------|
| 08.4410.70 | 441.050.008.0 | Métrica; M24 |

DAF, MAN, MERCEDES, RVI, SCANIA, VOLVO

Válvula Control de Altura / Height Control Valve

| REF. AIR-FREN | REF. MIDLAND |
|---------------|--------------|
| 08.8010.100 | KN27000 |

Válvula cabina VOLVO / Valve

| REF. AIR-FREN | REF. WABCO | REF. VOLVO |
|---------------|---------------|------------|
| 08.8010.60 | 464.007.002.0 | 8141934 |

VOLVO

Válvula cabina SCANIA / Valve

| REF. AIR-FREN | REF. WABCO | REF. SCANIA |
|---------------|---------------|--------------------|
| 08.8010.70 | 464.007.010.0 | 1399776 1430545 |

SCANIA

Válvula cabina / Valve

| REF. AIR-FREN | REF. WABCO | REF. O.E.M. |
|---------------|---------------|---|
| 08.8010.80 | 464.007.001.0 | DAF 759050 IVECO 08188642 MAN 81436106129 RENAULT 5010136105 |

DAF, IVECO, MAN, RENAULT

Válvula cabina MERCEDES / Valve

| REF. AIR-FREN | REF. WABCO | REF. MERCEDES |
|---------------|---------------|---------------|
| 08.8010.90 | 464.007.011.0 | 000 328 45 30 |

MERCEDES

VÁLVULAS NIVELADORAS / LEVEL VALVES



| REF. AIR-FREN | REF. KNORR |
|---------------|------------|
| 08.1260.00 | SV-1260 |
| 08.1294.00 | SV-1294 |
| 08.1310.00 | SV-1310 |
| 08.1313.00 | SV-1313 |
| 08.1361.00 | SV-1361 |
| 08.1362.00 | SV-1362 |

| Kit reparación / Repair kit | |
|-----------------------------|------------|
| REF. AIR-FREN | REF. KNORR |
| 08.R8020 | I-69784 |
| 08.R8020 | I-69784 |
| 08.R8020 | I-69784 |
| 08.R8020 | I-69784 |
| 08.R8020 | I-69784 |
| 08.R8020 | I-69784 |

IVECO, MAN, SCANIA, VOLVO, SETRA



| REF. AIR-FREN | REF. KNORR |
|---------------|------------|
| 08.1295.00 | SV-1295 |

| Kit reparación / Repair kit | |
|-----------------------------|------------|
| REF. AIR-FREN | REF. KNORR |
| 08.R8025 | I-86534 |

SCANIA, VOLVO, DAF, MAN



| REF. AIR-FREN | REF. KNORR |
|---------------|------------|
| 08.1280.00 | SV-1280 |

| Kit reparación / Repair kit | |
|-----------------------------|------------|
| REF. AIR-FREN | REF. KNORR |
| 08.R1280 | I-74651 |

MERCEDES, RENAULT, DAF, IVECO, VOLVO



| REF. AIR-FREN | REF. KNORR |
|---------------|------------|
| 08.1281.00 | SV-1281 |

| REF. AIR-FREN | REF. KNORR |
|---------------|------------|
| 08.R1281 | I-80010 |

MERCEDES



| REF. AIR-FREN | REF. KNORR |
|---------------|------------|
| 08.1303.00 | SV-1303 |

SCANIA, DAF



| REF. AIR-FREN | REF. KNORR |
|---------------|------------|
| 08.1323.00 | SV-1323 |

SCANIA



| REF. AIR-FREN | REF. KNORR |
|---------------|------------|
| 08.1325.00 | SV-1325 |

MAN



| REF. AIR-FREN | REF. KNORR |
|---------------|------------|
| 08.1329.00 | SV-1329 |

DAF



| REF. AIR-FREN | REF. KNORR |
|---------------|------------|
| 08.1330.00 | SV-1330 |

DAF



| REF. AIR-FREN | REF. KNORR |
|---------------|------------|
| 08.1350.00 | SV-1350 |

DAF, MAN



| REF. AIR-FREN | REF. KNORR |
|---------------|------------|
| 08.1395.00 | SV-1395 |

LECITRAILER



| REF. AIR-FREN | REF. KNORR |
|---------------|------------|
| 08.1399.00 | SV-1399 |

VOLVO



| REF. AIR-FREN | REF. KNORR |
|---------------|------------|
| 08.1410.00 | SV-1410 |

LECITRAILER



| REF. AIR-FREN | REF. KNORR |
|---------------|------------|
| 08.3115.00 | SV-3115 |
| 08.3111.00* | SV-3111 |

RENAULT, *Doble circuito/Double circuit.

Kit reparación / Repair kit

| REF. AIR-FREN | REF. KNORR |
|---------------|------------|
| 08.R3115 | I-87465 |
| 08.R3111 | I-78448 |



| REF. AIR-FREN | REF. KNORR |
|---------------|------------|
| 08.1288.00 | SV-1288 |

MAN



| REF. AIR-FREN | REF. KNORR |
|---------------|------------|
| 08.1307.00 | SV-1307 |

MAN



| REF. AIR-FREN | REF. KNORR |
|---------------|------------|
| 08.1345.00 | SV-1345 |

MAN



| REF. AIR-FREN | REF. KNORR |
|---------------|------------|
| 08.1411.00 | SV-1411 |

MAN

VÁLVULAS NIVELADORAS / LEVEL VALVES

Kit reparación / Repair kit



| REF. AIR-FREN | REF. BOSCH | REF. AIR-FREN | REF. BOSCH |
|---------------|------------|---------------|------------|
| 08.005001 | 0500005001 | 08.R8030 | 1507010007 |
| 08.005002 | 0500005002 | 08.R8030 | 1507010007 |
| 08.005003 | 0500005003 | 08.R8030 | 1507010007 |
| 08.005017 | 0500005017 | 08.R8030 | 1507010007 |
| 08.005018 | 0500005018 | 08.R8030 | 1507010007 |
| 08.005101 | 0500005101 | 08.R8030 | 1507010007 |
| 08.005102 | 0500005102 | 08.R8030 | 1507010007 |

MERCEDES, SCANIA, IVECO, MAGIRUS

Kit reparación / Repair kit



| REF. AIR-FREN | REF. BOSCH | REF. AIR-FREN | REF. BOSCH |
|---------------|------------|---------------|------------|
| 08.005006 | 0500005006 | 08.R8030 | 1507010007 |
| 08.005007 | 0500005007 | 08.R8030 | 1507010007 |
| 08.005104 | 0500005104 | 08.R8030 | 1507010007 |
| 08.005105 | 0500005105 | 08.R8030 | 1507010007 |

DAF, VOLVO, MERCEDES

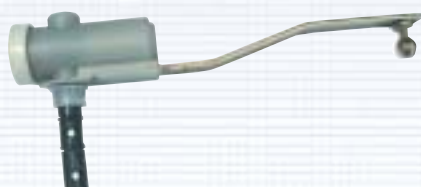

| REF. AIR-FREN | REF. BOSCH |
|---------------|------------|
| 08.R8035 | 1507010010 |

MERCEDES, SCANIA, IVECO



| REF. AIR-FREN | REF. BOSCH |
|---------------|------------|
| 08.413042 | 1507413042 |
| 08.413043 | 1507413043 |

MERCEDES, SCANIA, VOLVO



| REF. AIR-FREN | REF. BOSCH |
|---------------|------------|
| 08.004201 | 0500004201 |

RVI



| REF. AIR-FREN | REF. NEWAY |
|---------------|----------------------|
| 08.8718.00 | 90054007 90554147 |

| Kit reparación / Repair kit | |
|-----------------------------|------------|
| REF. AIR-FREN | REF. NEWAY |
| 08.R8718 | - |

SCANIA



| REF. AIR-FREN | REF. SCANIA |
|---------------|--------------------|
| 08.8718.10 | 1407139 1451839 |

SCANIA



| REF. AIR-FREN | REF. WABCO |
|--------------------------|--------------------------------|
| 08.5857240 08.5857241 | 464.005.005.0 464.005.004.0 |

| Kit reparación / Repair kit | |
|-----------------------------|--------------------------------|
| REF. AIR-FREN | REF. WABCO |
| 08.R005000 08.R005000 | 464.005.000.2 464.005.000.2 |

IVECO, PEGASO, MAN, SCANIA, MERCEDES



| REF. AIR-FREN | REF. HALDEX |
|--------------------------|----------------------|
| 08.9055.30 08.9055.40 | 90554241 90554243 |



| REF. AIR-FREN | REF. HALDEX |
|--------------------------|----------------------|
| 08.9055.50 08.9055.60 | 90554271 90554273 |

09

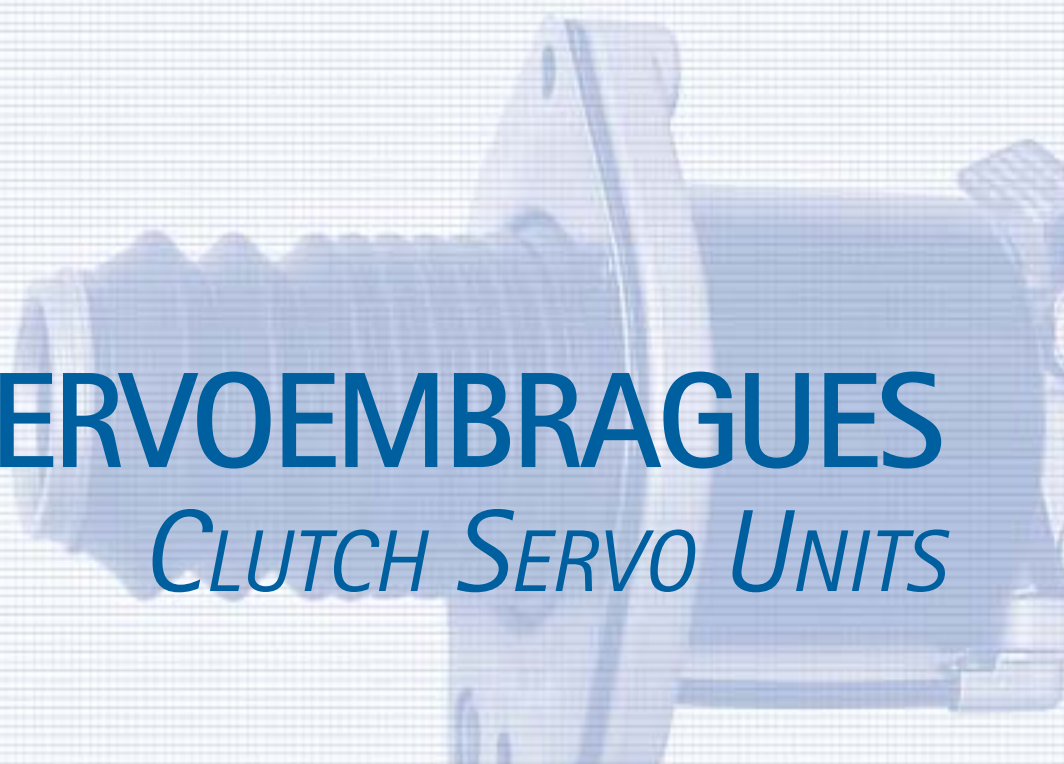

SERVOEMBRAGUES
CLUTCH SERVO UNITS



REF. AIR-FREN

REF. WABCO

09.051.114

970.051.114.0

DAF; ø 75 mm

Kit reparación / Repair kit

REF. AIR-FREN

REF. WABCO

09.R051.114

970.051.904.2



REF. AIR-FREN

REF. WABCO

09.051.129

970.051.129.0

DAF; ø 75 mm

Kit reparación / Repair kit

REF. AIR-FREN

REF. WABCO

09.R051.129

970.051.910.2



REF. AIR-FREN

REF. KONGSBERG

09.622.500

622.500

09.622.500

622.501

DAF; ø 80 mm

Kit reparación / Repair kit

REF. AIR-FREN

REF. KONGSBERG

09.R622.500

626788AM

09.R622.500

626788AM



REF. AIR-FREN

REF. KONGSBERG

09.622.508

622.508

626.784

625.111

626.580

DAF; ø 100 mm

Kit reparación / Repair kit

REF. AIR-FREN

REF. KONGSBERG

09.R622.508

626787



REF. AIR-FREN

REF. KONGSBERG

09.628.448

628.448

627.579

DAF; ø 100 mm

Kit reparación / Repair kit

REF. AIR-FREN

REF. KONGSBERG

09.R622.508

626787



REF. AIR-FREN

REF. WABCO

09.051.205

970.051.205.0

DAF; ø 80,5 mm

Kit reparación / Repair kit

REF. AIR-FREN

REF. WABCO

09.R051.205

970.051.907.2



REF. AIR-FREN

REF. KONGSBERG

09.628.036

628036AM

DAF; ø 100 mm

Kit reparación / Repair kit

REF. AIR-FREN

REF. KONGSBERG

09.R622.508

626787AM



REF. AIR-FREN

REF. KONGSBERG

09.628.447

628447AM

DAF; ø 100 mm

Kit reparación / Repair kit

REF. AIR-FREN

REF. KONGSBERG

09.R622.508

626787AM



REF. AIR-FREN

REF. KONGSBERG

09.628.258

628258AM

DAF; ø 100 mm

Kit reparación / Repair kit

REF. AIR-FREN

REF. KONGSBERG

09.R628.260

628305AM

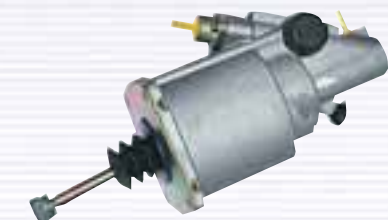

REF. AIR-FREN

REF. KONGSBERG

09.628.259

628259AM

DAF; ø 100 mm

Kit reparación / Repair kit

REF. AIR-FREN

REF. KONGSBERG

09.R628.260

628305AM

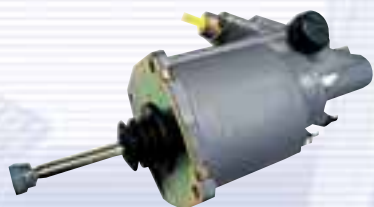

REF. AIR-FREN

REF. KONGSBERG

09.628.260

628260AM

DAF; ø 100 mm

Kit reparación / Repair kit

REF. AIR-FREN

REF. KONGSBERG

09.R628.260

628305AM



REF. AIR-FREN

REF. KONGSBERG

09.628.449

628449AM

DAF; ø 100 mm

Kit reparación / Repair kit

REF. AIR-FREN

REF. KONGSBERG

09.R628.260

628305AM



| REF. AIR-FREN | REF. WABCO |
|---------------|------------|
| 09.051.107P | 460.806.8 |
| 09.051.107P | 461.194.3 |
| 09.051.107P | 461.287.2 |

| Kit reparación / Repair kit | |
|-----------------------------|---------------|
| REF. AIR-FREN | REF. WABCO |
| 09.R051.107 | 970.051.906.2 |
| 09.R051.107 | 970.051.906.2 |
| 09.R051.107 | 970.051.906.2 |

IVECO, PEGASO; ø 100 mm



| REF. AIR-FREN | REF. IVECO |
|---------------|------------|
| 09.051.107I | - |

| Kit reparación / Repair kit | |
|-----------------------------|---------------|
| REF. AIR-FREN | REF. WABCO |
| 09.R051.107 | 970.051.906.2 |

IVECO; ø 100 mm



| REF. AIR-FREN | REF. KNORR |
|---------------|--------------------|
| 09.3000.00 | 1420362 1422149 |

| Kit reparación / Repair kit | |
|-----------------------------|------------|
| REF. AIR-FREN | REF. KNORR |
| 09.R3000 | 1423081 |

IVECO



| Válvula / Valve | |
|-----------------|--------------------|
| REF. AIR-FREN | REF. KNORR |
| 09.3100.00 | 1423079 1426591 |

VÁLVULA PARA SF30, SF44 / VALVE FOR SF30, SF44



| REF. AIR-FREN | REF. KNORR |
|---------------|--------------------|
| 09.4400.00 | 1424371 1422762 |

| Kit reparación / Repair kit | |
|-----------------------------|------------|
| REF. AIR-FREN | REF. KNORR |
| 09.R3000 | 1423081 |
| - | - |
| 09.R4500 | 1426590 |

IVECO



| REF. AIR-FREN | REF. KNORR |
|---------------|------------|
| 09.3264.00 | VG-3264 |
| 09.3269.00 | VG-3269 |

| Kit reparación / Repair kit | |
|-----------------------------|--------------|
| REF. AIR-FREN | REF. KNORR |
| 09.R3264 | II-35696/008 |

IVECO; ø 100 mm



| Kit reparación / Repair kit | | | |
|-----------------------------|---------------|---------------|---------------|
| REF. AIR-FREN | REF. WABCO | REF. AIR-FREN | REF. WABCO |
| 09.051.102P | 460.375.5 | 09.R051.114 | 970.051.904.2 |
| 09.051.102P | 460.719.3 | 09.R051.114 | 970.051.904.2 |
| 09.051.102P | 460.721.4 | 09.R051.114 | 970.051.904.2 |
| 09.051.126 | 970.051.126.0 | 09.R051.114 | 970.051.904.2 |

IVECO, PEGASO; ø 75 mm



| REF. AIR-FREN | REF. KNORR |
|---------------|------------|
| 09.3288.00 | VG-3288 |

IVECO



| REF. AIR-FREN | REF. KONGSBERG |
|---------------|----------------|
| 09.625.436 | 625436 AM |

MAN



| REF. AIR-FREN | REF. WABCO |
|---------------|---------------|
| 09.051.412 | 970.051.412.0 |

MAN, TGA



| Kit reparación / Repair kit | | | |
|-----------------------------|---------------|---------------|---------------|
| REF. AIR-FREN | REF. WABCO | REF. AIR-FREN | REF. WABCO |
| 09.051.406 | 970.051.406.0 | 09.R051.406 | 970.051.952.2 |

MAN, DAF; ø 80,5 mm



| Kit reparación / Repair kit | | | |
|-----------------------------|---------------|---------------|---------------|
| REF. AIR-FREN | REF. WABCO | REF. AIR-FREN | REF. WABCO |
| 09.051.414 | 970.051.414.0 | 09.R051.414 | 970.051.961.2 |

MAN, DAF; ø 108,8 mm



REF. AIR-FREN

REF. WABCO

09.051.111

970.051.111.0

MAN; ø 75 mm

Kit reparación / Repair kit

REF. AIR-FREN

REF. WABCO

09.R051.111

970.051.905.2



REF. AIR-FREN

REF. WABCO

09.051.132

970.051.132.0

MAN; ø 100 mm

Kit reparación / Repair kit

REF. AIR-FREN

REF. WABCO

09.R051.132

970.051.911.2



REF. AIR-FREN

REF. WABCO

09.051.307

970.051.307.0

MAN; ø 100 mm

Kit reparación / Repair kit

REF. AIR-FREN

REF. WABCO

09.R051.307

970.051.943.2



REF. AIR-FREN

REF. KNORR

09.3200.00

VG-3200

MAN; ø 75 mm

Kit reparación / Repair kit

REF. AIR-FREN

REF. KNORR

09.R3200

I-84613



REF. AIR-FREN

REF. KNORR

09.3208.00

VG-3208

09.3229.00

VG-3229

MAN; ø 100 mm

Kit reparación / Repair kit

REF. AIR-FREN

REF. KNORR

09.R3208

I-90586



REF. AIR-FREN

REF. KNORR

09.3261.00

VG-3261

MAN; ø 100 mm

Kit reparación / Repair kit

REF. AIR-FREN

REF. KNORR

09.R3261

II-31733/008



REF. AIR-FREN

09.3262.00

REF. KONGSBERG

VG-3262

MAN; ø 75 mm

Kit reparación / Repair kit

REF. AIR-FREN

09.R3262

REF. KNORR

II17767



REF. AIR-FREN

09.725.605

REF. KONGSBERG

625586AM

MAN; ø 100 mm

Kit reparación / Repair kit

REF. AIR-FREN

09.R725.605

REF. KONGSBERG

622427AM



REF. AIR-FREN

09.051.128

REF. WABCO

970.051.128.0

MERCEDES; ø 108 mm

Kit reparación / Repair kit

REF. AIR-FREN

09.R051.107

REF. WABCO

970.051.906.2



REF. AIR-FREN

09.051.131

REF. WABCO

970.051.131.0

MERCEDES, SETRA

Kit reparación / Repair kit

REF. AIR-FREN

09.R051.131

REF. WABCO

970.051.903.2



REF. AIR-FREN

09.051.137

REF. WABCO

970.051.137.0

MERCEDES; ø 75 mm

Kit reparación / Repair kit

REF. AIR-FREN

09.R051.137

REF. WABCO

970.051.910.2



REF. AIR-FREN

09.051.151

REF. WABCO

970.051.151.0

MERCEDES; ø 90 mm

Kit reparación / Repair kit

REF. AIR-FREN

09.R051.151

REF. WABCO

970.051.917.2



| REF. AIR-FREN | REF. WABCO |
|---------------|---------------|
| 09.051.158 | 970.051.158.0 |

MERCEDES; ø 108 mm

| Kit reparación / Repair kit | |
|-----------------------------|---------------|
| REF. AIR-FREN | REF. WABCO |
| 09.R051.158 | 970.051.916.2 |



| REF. AIR-FREN | REF. WABCO |
|---------------|---------------|
| 09.051.159 | 970.051.159.0 |

MERCEDES; ø 108 mm

| Kit reparación / Repair kit | |
|-----------------------------|---------------|
| REF. AIR-FREN | REF. WABCO |
| 09.R051.158 | 970.051.916.2 |



| REF. AIR-FREN | REF. WABCO |
|---------------|---------------|
| 09.051.164 | 970.051.164.0 |

MERCEDES; ø 108 mm

| Kit reparación / Repair kit | |
|-----------------------------|---------------|
| REF. AIR-FREN | REF. WABCO |
| 09.R051.164 | 970.051.945.2 |



| REF. AIR-FREN | REF. WABCO |
|---------------|---------------|
| 09.051.179 | 970.051.179.0 |

MERCEDES; ø 108 mm

| Kit reparación / Repair kit | |
|-----------------------------|---------------|
| REF. AIR-FREN | REF. WABCO |
| 09.R051.179 | 970.051.955.2 |



| REF. AIR-FREN | REF. KNORR |
|---------------|------------|
| 09.3361.00 | VG-3361 |

MERCEDES; ø 108 mm

| Kit reparación / Repair kit | |
|-----------------------------|-------------|
| REF. AIR-FREN | REF. KNORR |
| 09.R3361 | I-14195 / 8 |

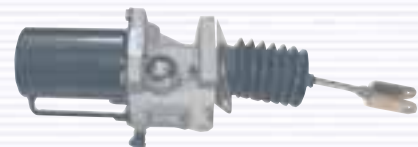

| REF. AIR-FREN | REF. CLAYTON/WABCO |
|---------------|------------------------------|
| 09.1605.00 | APGA/1605/P 970.190.005.0 |

MERCEDES, VOLVO, DAF

| Kit reparación / Repair kit | |
|-----------------------------|---------------------------|
| REF. AIR-FREN | REF. CLAYTON/WABCO |
| 09.R1605 | GA/29317 890.131.332.0 |



| REF. AIR-FREN | REF. WABCO |
|---------------|---------------|
| 09.051.431 | 970.051.431.0 |
| 09.051.405 | 970.051.405.0 |

MERCEDES; ø 108 mm

| Kit reparación / Repair kit | |
|-----------------------------|---------------|
| REF. AIR-FREN | REF. WABCO |
| 09.R051.431 | 970.051.974.2 |



| REF. AIR-FREN | REF. WABCO |
|---------------|---------------|
| 09.051.407 | 970.051.407.0 |

MERCEDES; ø 108 mm

| Kit reparación / Repair kit | |
|-----------------------------|---------------|
| REF. AIR-FREN | REF. WABCO |
| 09.R051.407 | 970.051.943.2 |



| REF. AIR-FREN | REF. KONGSBERG |
|---------------|----------------|
| 09.244.224 | 625524AM |

RENAULT; ø 100 mm

| Kit reparación / Repair kit | |
|-----------------------------|----------------|
| REF. AIR-FREN | REF. KONGSBERG |
| 09.R244.224 | 626733AM |



| REF. AIR-FREN | REF. KONGSBERG |
|---------------|----------------|
| 09.244.402 | 626162AM |

RENAULT; ø 100 mm

| Kit reparación / Repair kit | |
|-----------------------------|----------------|
| REF. AIR-FREN | REF. KONGSBERG |
| 09.R244.402 | 626729AM |



| REF. AIR-FREN | REF. KONGSBERG |
|---------------|----------------|
| 09.245.752 | 626853AM |

RENAULT; ø 80 mm

| Kit reparación / Repair kit | |
|-----------------------------|----------------|
| REF. AIR-FREN | REF. KONGSBERG |
| 09.R245.752 | 626731AM |



| REF. AIR-FREN | REF. WABCO |
|---------------|---------------|
| 09.051.438 | 970.051.438.0 |

RENAULT KERAX



| REF. AIR-FREN | REF. WABCO |
|---------------|---------------|
| 09.051.124 | 970.051.124.0 |

RENAULT; ø 100 mm

| Kit reparación / Repair kit | |
|-----------------------------|---------------|
| REF. AIR-FREN | REF. WABCO |
| 09.R051.124 | 970.051.906.2 |



| REF. AIR-FREN | REF. WABCO |
|---------------|---------------|
| 09.051.209 | 970.051.209.0 |

RENAULT; ø 100 mm

| Kit reparación / Repair kit | |
|-----------------------------|---------------|
| REF. AIR-FREN | REF. WABCO |
| 09.R051.209 | 970.051.909.2 |



| REF. AIR-FREN | REF. KONGSBERG |
|---------------|----------------|
| 09.625.384 | 625384AM |

RENAULT; ø 80 mm

| Kit reparación / Repair kit | |
|-----------------------------|----------------|
| REF. AIR-FREN | REF. KONGSBERG |
| 09.R625.384 | 626731AM |



| REF. AIR-FREN | REF. KONGSBERG |
|---------------|----------------|
| 09.627.612 | 627612AM |

RENAULT; ø 100 mm

| Kit reparación / Repair kit | |
|-----------------------------|----------------|
| REF. AIR-FREN | REF. KONGSBERG |
| 09.R627.612 | 626734 |



| REF. AIR-FREN | REF. WABCO |
|---------------|---------------|
| 09.051.102 | 970.051.102.0 |

SCANIA; ø 75 mm

| Kit reparación / Repair kit | |
|-----------------------------|---------------|
| REF. AIR-FREN | REF. WABCO |
| 09.R051.114 | 970.051.904.2 |



| REF. AIR-FREN | REF. WABCO |
|---------------|---------------|
| 09.051.107 | 970.051.107.0 |

SCANIA; ø 100 mm

| Kit reparación / Repair kit | |
|-----------------------------|---------------|
| REF. AIR-FREN | REF. WABCO |
| 09.R051.107 | 970.051.906.2 |



| REF. AIR-FREN | REF. KONGSBERG |
|---------------|----------------|
| 09.1331.770 | 622199AM |

SCANIA; ø 100 mm

| Kit reparación / Repair kit | |
|-----------------------------|----------------|
| REF. AIR-FREN | REF. KONGSBERG |
| 09.R371.612 | 625282AM |



REF. AIR-FREN

REF. KONGSBERG

09.1337.966

624199

SCANIA; ø 100 mm

Kit reparación / Repair kit

REF. AIR-FREN

REF. KONGSBERG

09.R371.612

625282AM



REF. AIR-FREN

REF. KONGSBERG

09.360.717

622107AM

SCANIA; ø 100 mm

Kit reparación / Repair kit

REF. AIR-FREN

REF. KONGSBERG

09.R360.717

622158AM



REF. AIR-FREN

REF. KONGSBERG

09.371.612

622108AM

SCANIA; ø 100 mm

Kit reparación / Repair kit

REF. AIR-FREN

REF. KONGSBERG

09.R371.612

625282AM



REF. AIR-FREN

REF. KONGSBERG

09.625.359

625359

SCANIA; ø 100 mm

Kit reparación / Repair kit

REF. AIR-FREN

REF. KONGSBERG

09.R625.359

-



REF. AIR-FREN

REF. WABCO

-

974.010.001.0

SCANIA; ø 100 mm

Kit reparación / Repair kit

REF. AIR-FREN

REF. KONGSBERG

09.655.435

626639AM

VOLVO; ø 95 mm

REF. AIR-FREN

REF. KONGSBERG

09.R655.435

622095AM





| REF. AIR-FREN | REF. KONGSBERG |
|---------------|----------------|
| 09.655.639 | 626392AM |

VOLVO; ø 80 mm

| Kit reparación / Repair kit | |
|-----------------------------|----------------|
| REF. AIR-FREN | REF. KONGSBERG |
| 09.R655.639 | 626703AM |



| REF. AIR-FREN | REF. KONGSBERG |
|---------------|----------------|
| 09.628.492 | 628492 |

VOLVO; ø 100 mm

| Kit reparación / Repair kit | |
|-----------------------------|----------------|
| REF. AIR-FREN | REF. KONGSBERG |
| 09.R628.492 | 628476 |



| REF. AIR-FREN | REF. KONGSBERG |
|---------------|----------------|
| 09.628.493 | 628493 |

VOLVO; ø 100 mm

| Kit reparación / Repair kit | |
|-----------------------------|----------------|
| REF. AIR-FREN | REF. KONGSBERG |
| 09.R628.492 | 628476 |



| REF. AIR-FREN | REF. KONGSBERG |
|---------------|----------------|
| 09.628.494 | 628494AM |

VOLVO; ø 100 mm

| Kit reparación / Repair kit | |
|-----------------------------|----------------|
| REF. AIR-FREN | REF. KONGSBERG |
| 09.R628.492 | 628476 |



| REF. AIR-FREN | REF. KONGSBERG |
|---------------|----------------|
| 09.622.504 | 622504AM |

LEYLAND; ø 80 mm

| Kit reparación / Repair kit | |
|-----------------------------|----------------|
| REF. AIR-FREN | REF. KONGSBERG |
| 09.R622.504 | 625218AM |



| REF. AIR-FREN | REF. KONGSBERG |
|---------------|----------------|
| 09.625.290 | 625290AM |

LEYLAND; ø 80 mm

| Kit reparación / Repair kit | |
|-----------------------------|----------------|
| REF. AIR-FREN | REF. KONGSBERG |
| 09.R625.290 | 625475AM |



| REF. AIR-FREN | REF. WABCO |
|---------------|--------------------------------|
| 09.051.176 | 970.051.176.0 970.051.165.0 |

EVO-BUS; ZF

| Kit reparación / Repair kit | |
|-----------------------------|---------------|
| REF. AIR-FREN | REF. WABCO |
| 09.R051.176 | 970.051.950.2 |



| REF. AIR-FREN | REF. WABCO |
|---------------|---|
| 09.051.183 | 970.051.183.0 970.051.177.0 970.051.156.0 |

EVO-BUS; ZF; ø 75 mm

| Kit reparación / Repair kit | |
|-----------------------------|---------------|
| REF. AIR-FREN | REF. WABCO |
| 09.R051.129 | 970.051.910.2 |



| REF. AIR-FREN | REF. KONGSBERG |
|---------------|----------------|
| 09.348.735 | 627762AM |

DAF; ø 22 mm

| Kit reparación / Repair kit | |
|-----------------------------|----------------|
| REF. AIR-FREN | REF. KONGSBERG |
| 09.R348.735 | 627201AM |



| REF. AIR-FREN | REF. KONGSBERG |
|---------------|----------------|
| 09.715.611 | 623160AM |

MAN; ø 24 mm

| Kit reparación / Repair kit | |
|-----------------------------|----------------|
| REF. AIR-FREN | REF. KONGSBERG |
| 09.R715.611 | 625976AM |



| REF. AIR-FREN | REF. KONGSBERG |
|---------------|----------------|
| 09.715.612 | 623109AM |

MAN; ø 26 mm

| Kit reparación / Repair kit | |
|-----------------------------|----------------|
| REF. AIR-FREN | REF. KONGSBERG |
| 09.R715.612 | 625977AM |

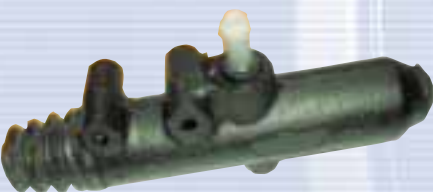

| REF. AIR-FREN | REF. FAG |
|---------------|------------|
| 09.295.300 | KG2604.1.1 |

MERCEDES; ø 26 mm

| Kit reparación / Repair kit | |
|-----------------------------|----------|
| REF. AIR-FREN | REF. FAG |
| 09.R295.300 | RK26504 |



| REF. AIR-FREN | REF. MERCEDES |
|---------------|---------------|
| 09.295.530 | 001 295 53 06 |

MERCEDES

| Kit reparación / Repair kit | |
|-----------------------------|---------------|
| REF. AIR-FREN | REF. MERCEDES |
| 09.R295.530 | 000 290 46 67 |



| REF. AIR-FREN | REF. KONGSBERG |
|---------------|----------------|
| 09.358.801 | 624502AM |

SCANIA; ø 26 mm

| Kit reparación / Repair kit | |
|-----------------------------|----------------|
| REF. AIR-FREN | REF. KONGSBERG |
| 09.R358.801 | 623157AM |



| REF. AIR-FREN | REF. KONGSBERG |
|---------------|----------------|
| 09.361.136 | 624503AM |

SCANIA; ø 26 mm

| Kit reparación / Repair kit | |
|-----------------------------|----------------|
| REF. AIR-FREN | REF. KONGSBERG |
| 09.R358.801 | 623157AM |



| REF. AIR-FREN | REF. SCANIA |
|---------------|-------------|
| 09.446.414 | 446414 |

SCANIA

| Kit reparación / Repair kit | |
|-----------------------------|-------------|
| REF. AIR-FREN | REF. SCANIA |
| 09.R446.414 | 639088 |



| Cilindro maestro / Master cylinder | |
|------------------------------------|------------|
| REF. AIR-FREN | REF. VOLVO |
| 09.620.462 | 1620462 |
| | 1669488 |
| | 1581209 |
| | 1614351 |

VOLVO

| Kit reparación / Repair kit | |
|-----------------------------|------------|
| REF. AIR-FREN | REF. VOLVO |
| 09.R620.462 | 271106-7 |

Ad. RK2866 FAG



| Cilindro maestro / Master cylinder | |
|------------------------------------|------------|
| REF. AIR-FREN | REF. VOLVO |
| 09.628.218 | 1628218 |

VOLVO

| Kit reparación / Repair kit | |
|-----------------------------|------------|
| REF. AIR-FREN | REF. VOLVO |
| 09.R628.218 | 3094523 |



REF. AIR-FREN

09.295.040

REF. MERCEDES

002 295 04 07
001 295 03 07

MERCEDES

Kit reparación / Repair kit

REF. AIR-FREN

09.R295.040

REF. MERCEDES

000 290 09 11



REF. AIR-FREN

09.295.820

REF. MERCEDES

000 295 82 06
000 295 68 06

MERCEDES

Kit reparación / Repair kit

REF. AIR-FREN

09.R295.820

REF. MERCEDES

000 290 46 67



REF. AIR-FREN

09.291.190

REF. DAF

1291190

DAF

Kit reparación / Repair kit

REF. AIR-FREN

09.R291.190

REF. DAF

1354518



REF. AIR-FREN

09.094.660

REF. DAF

094660
223443
894880

DAF

Kit reparación / Repair kit

REF. AIR-FREN

09.R094.660

REF. DAF

1237505



REF. AIR-FREN

09.265.209

REF. DAF

1265209

DAF; Ø int. 24 mm.

Kit reparación / Repair kit

REF. AIR-FREN

09.R265.209

REF. DAF

1316359



REF. AIR-FREN

09.339.412

REF. DAF

1339412

DAF; Ø int. 26 mm.

Kit reparación / Repair kit

REF. AIR-FREN

09.R339.412

REF. DAF

1373531



| REF. AIR-FREN | REF. DAF |
|---------------|----------|
| 09.334.604 | 334604 |

DAF

| Kit reparación / Repair kit | |
|-----------------------------|----------|
| REF. AIR-FREN | REF. DAF |
| 09.R334.604 | - |



| REF. AIR-FREN | REF. MERCEDES |
|---------------|--------------------------------|
| 09.295.540 | 001 295 54 07 001 295 96 07 |

MERCEDES

| Kit reparación / Repair kit | |
|-----------------------------|---------------|
| REF. AIR-FREN | REF. MERCEDES |
| 09.R295.540 | 000 290 45 67 |



| REF. AIR-FREN | REF. MERCEDES |
|---------------|--------------------------------|
| 09.295.600 | 001 295 60 06 001 295 29 06 |

MERCEDES

| Kit reparación / Repair kit | |
|-----------------------------|--------------------------------|
| REF. AIR-FREN | REF. MERCEDES |
| 09.R295.600 | 000 290 46 67 000 290 34 12 |



| REF. AIR-FREN | REF. DAF |
|---------------|------------------|
| 09.355.973 | 355973 292962 |

SCANIA

| Kit reparación / Repair kit | |
|-----------------------------|----------|
| REF. AIR-FREN | REF. DAF |
| 09.R355.973 | 550440 |



| REF. AIR-FREN | REF. WABCO |
|---------------|------------|
| 09.1883.60 | 460.788.5 |

RVI

| Kit reparación / Repair kit | |
|-----------------------------|------------|
| REF. AIR-FREN | REF. WABCO |
| 09.R1883.60 | 404.969.0 |



REF. AIR-FREN

REF. KONGSBERG

09.623.104

623104AM

RENAULT REF: 5000877187; Ø 26 mm.

Kit reparación / Repair kit

REF. AIR-FREN

REF. RENAULT

09.R623.104

-



REF. AIR-FREN

REF. KONGSBERG

09.623.105

623105AM

RENAULT REF: 5000877188; Ø 28 mm.

Kit reparación / Repair kit

REF. AIR-FREN

REF. RENAULT

09.R623.105

-



REF. AIR-FREN

REF. KONGSBERG

09.623.106

623106AM

RENAULT REF: 5000792359; Ø 26 mm.

Kit reparación / Repair kit

REF. AIR-FREN

REF. KONGSBERG

09.R623.106

626243AM



REF. AIR-FREN

REF. KONGSBERG

09.624.248

624248AM

RENAULT REF: 5010251357; Ø 28 mm.

Kit reparación / Repair kit

REF. AIR-FREN

REF. KONGSBERG

09.R624.248

626165AM



REF. AIR-FREN

REF. KONGSBERG

09.626.159

626159AM

RENAULT REF: 5001834842; Ø 28 mm.

Kit reparación / Repair kit

REF. AIR-FREN

REF. KONGSBERG

09.R626.159

626163AM



| REF. AIR-FREN | REF. MAN |
|---------------|--|
| 09.715.607 | 81 30715 61 15 81 30715 60 77 81 30715 60 65 |

MAN

| Kit reparación / Repair kit | |
|-----------------------------|----------|
| REF. AIR-FREN | REF. MAN |
| 09.R715.607 | - |



| REF. AIR-FREN | REF. MAN |
|---------------|----------------|
| 09.715.613 | 81 30715 61 35 |

MAN

| Kit reparación / Repair kit | |
|-----------------------------|----------------|
| REF. AIR-FREN | REF. MAN |
| 09.R715.613 | 81 30715 61 13 |



| REF. AIR-FREN | REF. FAG |
|---------------|----------|
| 09.716.605 | KN25021 |

MAN

| Kit reparación / Repair kit | |
|-----------------------------|----------|
| REF. AIR-FREN | REF. FAG |
| 09.R716.605 | - |



| REF. AIR-FREN | REF. MERCEDES |
|---------------|---------------|
| 09.295.950 | 001 295 95 06 |

MERCEDES

| Kit reparación / Repair kit | |
|-----------------------------|---------------|
| REF. AIR-FREN | REF. MERCEDES |
| 09.R295.950 | - |

10



OTRAS VÁLVULAS *OTHER VALVES*

Secador de aire / Air dryer



| REF. AIR-FREN | REF. WABCO |
|---------------|--------------------------------------|
| 10.410102 | 432.410.102.0 [8,1 bar, 24 volt] |
| 10.410103 | 432.410.020.0 [9,5 bar, 24 volt] |
| 10.410104 | 432.410.110.0 [12,5 bar, 24 volt] |
| 10.410105 | 432.410.029.0 [8,1 bar, 12 volt] |

IVECO, PEGASO, VOLVO, SCANIA, DAF, MAN

| Kit reparación / Repair kit | |
|-----------------------------|--------------------------------|
| REF. AIR-FREN | REF. WABCO |
| 10.R611004 | 432.410.000.2 432.410.001.2 |
| 10.R611004 | 432.410.000.2 432.410.001.2 |
| 10.R611004 | 432.410.000.2 432.410.001.2 |
| 10.R611004 | 432.410.000.2 432.410.001.2 |
| 10.R611005 | 403.983.1 (*) |
| 10.R611006 | 432.410.001.2 (**) |

(*) KIT SOLO SECADOR / Only for dryer

(**) KIT SOLO REGULADOR / Only for regulator

| REF. AIR-FREN | REF. ORIGINAL |
|---------------|--------------------------------------|
| 10.410110 | Bosch 0 484 460 158 |
| 10.410114 | Wabco 432.410.116.0 432.410.117.0 |
| 10.410115 | Bosch 0 484 460 135 Knorr LA-8284 |
| 10.410116 | Wabco 432.410.083.0 |
| 10.410120 | Bosch 0 484 460 160 Knorr LA-8211 |
| 10.410121 | Knorr LA-8212 |



| REF. AIR-FREN | REF. WABCO |
|---------------|---------------|
| 10.410106 | 432.420.000.0 |

MAN, MERCEDES

| Kit reparación / Repair kit | |
|-----------------------------|------------|
| REF. AIR-FREN | REF. WABCO |
| 10.R611005 | 403.983.1 |



| REF. AIR-FREN | REF. KNORR |
|---------------|------------|
| 10.410111 | LA-6228 |

MAN

| Kit reparación / Repair kit | |
|-----------------------------|------------|
| REF. AIR-FREN | REF. KNORR |
| 10.R611011 | I-87918 |

Cartucho secador / Air dryer filter (M 39 x 1,5)



| REF. AIR-FREN | REF. WABCO |
|---------------|---------------|
| 10.1867.10 | 432.410.020.2 |
| 10.1867.50 | DAF 1391510 |

MERCEDES, SCANIA, IVECO, PEGASO, DAF, MAN, RVI

Cartucho secador Scania / Air dryer filter (1 1/4")

| REF. AIR-FREN | REF. WABCO |
|---------------|--------------------------------|
| 10.1867.20 | 432.410.226.2 432.410.927.2 |

SCANIA

Cartucho secador Haldex / Air dryer filter

| REF. AIR-FREN | REF. HALDEX |
|---------------|-------------|
| 10.1867.80 | 78964 |

Cartucho secador con filtro coalescente / Air dryer

| REF. AIR-FREN | REF. WABCO |
|---------------|---------------|
| 10.1867.70 | 432.901.223.2 |

MERCEDES, DAF, SCANIA, VOLVO, MAN

Cartucho secador Bendix / Air dryer

| REF. AIR-FREN | REF. BENDIX | MODELO / MODEL |
|---------------|-------------|----------------|
| 10.1867.60 | 101900 | AD-2 |

Cartucho doble secador Haldex / Haldex double air dryer filter

| REF. AIR-FREN | REF. HALDEX |
|---------------|-------------|
| 10.1867.30 | 71034 |

SCANIA, VOLVO

Cartucho secador para secador AD-9 / Cartridge Bendix

| REF. AIR-FREN | REF. BENDIX | FILTRO / CARTRIDGE |
|---------------|------------------|--------------------|
| 10.1867.40 | 107794 107796 | AD-9 |

Cable calentador eléctrico / Electrical connection for heater



REF. AIR-FREN

REF. WABCO

10.410100

894.600.451.2

IVECO, VOLVO, SCANIA, DAF, MAN, RVI

Unidad procesamiento aire / Air Processing unit



Kit reparación / Repair kit

REF. AIR-FREN

REF. WABCO

REF. AIR-FREN

REF. WABCO

10.410107

932.400.006.0
932.400.005.0
932.400.001.0
932.400.002.0

10.R611010

932.400.000.2

DAF, MERCEDES

Unidad procesamiento aire / Air Processing unit



Kit reparación / Repair kit

REF. AIR-FREN

REF. WABCO

REF. AIR-FREN

REF. WABCO

10.410127

932.400.003.0

10.R611010

932.400.000.2

DAF, MERCEDES

Unidad procesamiento aire / Air Processing unit

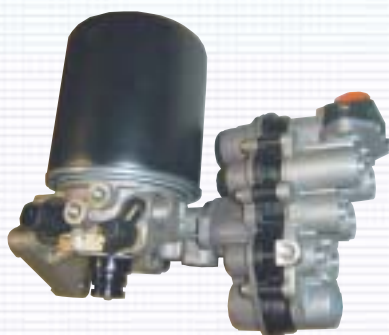

REF. AIR-FREN

REF. WABCO

10.500100

932.500.013.0
932.500.014.0
932.500.006.0
932.500.007.0

DAF, MERCEDES; Con Sensor / With Sensor

Unidad procesamiento aire / Air Processing unit



REF. AIR-FREN

REF. WABCO

10.500200

932.500.003.0
932.500.004.0

MERCEDES, DAF; Sin Sensor / Without Sensor

Secador doble Volvo / Volvo double air dryer
Kit reparación / Repair kit

| REF. AIR-FREN | REF. WABCO | REF. AIR-FREN | REF. WABCO |
|---------------|---------------|---------------|---------------|
| 10.431100 | 432.431.008.0 | 10.R431100 | 432.431.002.2 |

VOLVO

Solenoid para secador Volvo / Solenoid for air dryer

| REF. AIR-FREN | REF. WABCO |
|---------------|---------------|
| 10.432200 | 442.019.135.1 |

VOLVO

Secador para APU / APU Air dryer
Kit reparación / Repair kit

| REF. AIR-FREN | REF. KNORR | REF. AIR-FREN | REF. KNORR |
|---------------|--------------------|---------------|---------------------------|
| 10.9010.00 | LA-9010 LA-9011 | 10.R611007 | I1325810051 I36251/008 |

MERCEDES



| REF. AIR-FREN | REF. KNORR |
|---------------|------------|
| 10.8065.00 | LA-8065 |

RVI, KERAX

Condensador-Separador / Condenser-Separator

| REF. AIR-FREN | REF. HALDEX |
|---------------|----------------|
| 10.410113 | 92695 71360 |

VOLVO; 24 VOLTIOS / 24 VOLT.



Secador de Aire / Air Dryer

Kit reparación / Repair kit

| REF. AIR-FREN | REF. KNORR | REF. AIR-FREN | REF. KNORR |
|---------------|------------|---------------|------------|
| 10.6710.00 | LA-6710 | 10.R611008 | I-90121 |
| 10.6711.00 | LA-6711 | | |

MAN, VOLVO



Secador de Aire / Air Dryer

Kit reparación / Repair kit

| REF. AIR-FREN | REF. KNORR | REF. AIR-FREN | REF. KNORR |
|---------------|------------|---------------|-------------------------------|
| 10.8209.00 | LA-8209 | 10.R611009 | I136248 I136249 I136250 |
| 10.8219.00 | LA-8219 | | |
| 10.8222.00 | LA-8222 | | |
| 10.8286.00 | LA-8286 | | |

IVECO, VOLVO



Secadora para APU / APU Air Dryer

| REF. AIR-FREN | REF. KNORR |
|---------------|------------|
| 10.8130.00 | LA-8130 |

DAF



Secadora para APU / APU Air Dryer

| REF. AIR-FREN | REF. KNORR |
|---------------|------------|
| 10.8125.00 | LA-8125 |

IVECO

Unidad procesamiento aire / Air processing unit
REF. AIR-FREN
REF. KNORR

10.4535.00

 ZB-4535
ZB-4534

MERCEDES

Unidad de procesamiento de aire / Air processing air
REF. AIR-FREN
REF. KNORR

10.4593.00

ZB-4593

IVECO

Unidad de procesamiento de aire / Air Processing unit
REF. AIR-FREN
REF. KNORR

10.4578.00

ZB-4578

DAF

Unidad de procesamiento de aire / Air Processing unit
REF. AIR-FREN
REF. KNORR

10.4587.00

ZB-4587

IVECO



| Secador de Aire / Air dryer | | | Kit reparación / Repair kit | |
|-----------------------------|-------------|-----------------|-----------------------------|-------------|
| REF. AIR-FREN | REF. BENDIX | MODELO / MODEL | REF. AIR-FREN | REF. BENDIX |
| 10.410108 | 065225 | AD-9 12 volt | 10.R410109.1 | 107798 |



| Válvula / Purge valve (12 volt) | | Kit reparación / Repair kit | |
|---------------------------------|-------------|-----------------------------|-------------|
| REF. AIR-FREN | REF. BENDIX | REF. AIR-FREN | REF. BENDIX |
| 10.410108.1 | 5004341 | 10.R410108 | 109578 |



| Secador de Aire / Air dryer | | | Kit reparación / Repair kit | |
|-----------------------------|-------------|-----------------|-----------------------------|-------------|
| REF. AIR-FREN | REF. BENDIX | MODELO / MODEL | REF. AIR-FREN | REF. BENDIX |
| 10.410109 | 065224 | AD-9 24 volt | 10.R410109.1 | 107798 |



| Válvula / Purge valve (24 volt) | | Kit reparación / Repair kit | |
|---------------------------------|-------------|-----------------------------|-------------|
| REF. AIR-FREN | REF. BENDIX | REF. AIR-FREN | REF. BENDIX |
| 10.410109.1 | 5004342 | 10.R410109 | 109579 |

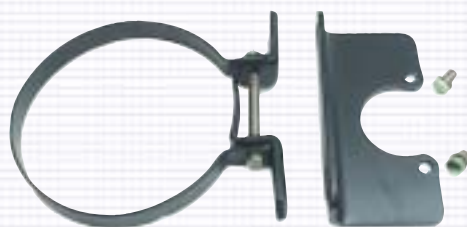

Abrazadera secador AD-9 / Clamp assy

| REF. AIR-FREN | REF. BENDIX |
|---------------|-------------|
| 10.410109.2 | 109695 |



Válvula de Chequeo / Single check valve AD-9

| REF. AIR-FREN | REF. BENDIX |
|---------------|-------------|
| 10.1077.00 | 107799 |
| 10.1078.00 | 107800 |

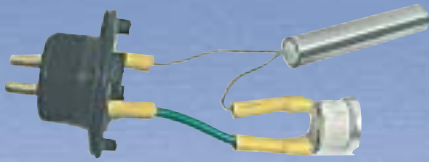
Calentador eléctrico 24 Volt. / Heater air dryer 24 volt.
REF. AIR-FREN
REF. WABCO

10.410200

894.260.040.2

MB, VOLVO, SCANIA, DAF, MAN, RVI

REF. AIR-FREN
REF. WABCO

10.410205

894.260.049.2

MERCEDES

REF. AIR-FREN
REF. WABCO

10.410210

894.260.043.2

VOLVO

REF. AIR-FREN
REF. WABCO

10.410215

894.260.047.2

SCANIA

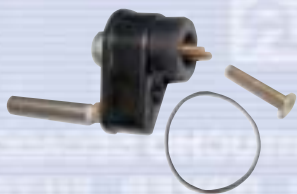
REF. AIR-FREN
REF. KNORR

10.410220

II-30654

REF. AIR-FREN
REF. KNORR

10.410225

-

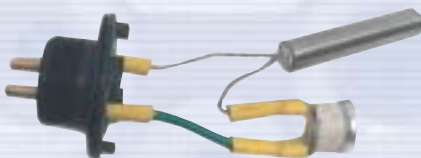
Calentador eléctrico 12 Volt. / Heater air dryer 12 volt.

REF. AIR-FREN
REF. WABCO

10.410230

894.260.044.2



Válvula desconexión principal caja cambios / Splitter valve

Kit reparación / Repair kit

| REF. AIR-FREN | REF. KNORR | REF. AIR-FREN |
|---------------|--------------------|------------------------|
| 10.7060.00 | SV-3367 SV-3368 | 10.R7050I 10.R7060I |

IVECO, PEGASO, DAF, MAN, ZF



Válvula control direccional 3/2 vías / 3/2 directional control valve

Kit reparación / Repair kit

| REF. AIR-FREN | REF. WABCO | REF. AIR-FREN | REF. WABCO |
|---------------|---------------|---------------|---------------|
| 10.4600.40 | 463.046.004.0 | 10.R4600 | 463.046.001.2 |

DAF, MERCEDES



Válvula caja de cambios / Splitter valve

Kit reparación / Repair kit

| REF. AIR-FREN | REF. KNORR | REF. AIR-FREN | REF. KNORR |
|---------------|------------|---------------|------------|
| 10.3371.00 | SV-3371 | 10.R3371 | - |



Válvula control direccional 3/2 vías / 3/2 directional control valve

| REF. AIR-FREN | REF. KNORR |
|---------------|------------|
| 10.3302.00 | SV-3302 |

DAF, MAN, IVECO, RENAULT, MERCEDES



Válvula control direccional 5/2 vías / 5/2 directional control valve

Kit reparación / Repair kit

| REF. AIR-FREN | REF. WABCO | REF. AIR-FREN | REF. WABCO |
|---------------|---------------|---------------|---------------|
| 10.6300.00 | 463.063.002.0 | 10.R6300 | 463.063.000.2 |

MERCEDES, ZF



Válvula control direccional 5/2 vías / 5/2 directional control valve

Kit reparación / Repair kit

| REF. AIR-FREN | REF. WABCO | REF. AIR-FREN | REF. WABCO |
|---------------|---------------|---------------|---------------|
| 10.6300.10 | 463.063.003.0 | 10.R6300 | 463.063.000.2 |

MERCEDES, ZF



Inhibidor / Gearbox valve

Kit reparación / Repair kit

| REF. AIR-FREN | REF. SCANIA | REF. AIR-FREN | REF. SCANIA |
|---------------|-------------|---------------|-------------|
| 10.3195.00 | 1319557 | 10.R3195 | - |

SCANIA



Inhibidor / Gearbox valve

| REF. AIR-FREN | REF. SCANIA |
|---------------|-------------|
| 10.2182.37 | 218237 |

SCANIA



Inhibidor / Gearbox valve

Kit reparación / Repair kit

| REF. AIR-FREN | REF. VOLVO | REF. AIR-FREN | REF. VOLVO |
|---------------|------------|---------------|------------|
| 10.6800.00 | 1068951 | 10.R6800 | - |

VOLVO



Inhibidor / Gearbox valve

| REF. AIR-FREN | REF. VOLVO |
|---------------|--------------------|
| 10.6900.00 | 1669324 3095080 |

VOLVO



Inhibidor / Gearbox valve

Kit reparación / Repair kit

| REF. AIR-FREN | REF. VOLVO | REF. AIR-FREN | REF. VOLVO |
|---------------|--------------------|---------------|------------|
| 10.9200.00 | 3092123 3091916 | 10.R9200 | - |

VOLVO



Inhibidor / Gearbox valve

| REF. AIR-FREN | REF. VOLVO |
|---------------|------------|
| 10.6700.00 | 8172628 |

VOLVO

Electroválvula / Electrovalve



Kit reparación / Repair kit

| REF. AIR-FREN | REF. SCANIA | REF. AIR-FREN | REF. SCANIA |
|---------------|---|---------------|-------------|
| 10.3340.00 | 1334037 114160 1423566 1488083 | 10.R3340 | - |

SCANIA

Solenoid / Solenoid

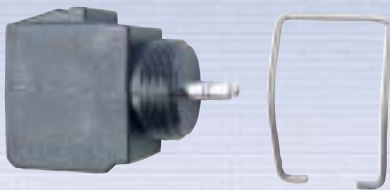

Kit reparación / Repair kit

| REF. AIR-FREN | REF. SCANIA | REF. AIR-FREN | REF. SCANIA |
|---------------|-------------|---------------|-------------|
| 10.3440.00 | - | 10.R3440 | - |

SCANIA

Electroválvula / Electrovalve



| REF. AIR-FREN | REF. DAF |
|---------------|----------|
| 10.3340.10 | 1457276 |

DAF XF 95

Electroválvula / Electrovalve

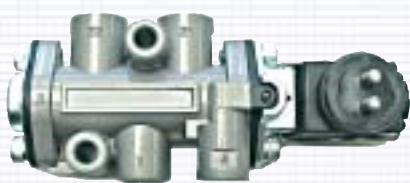

| REF. AIR-FREN | REF. DAF |
|---------------|----------|
| 10.3340.20 | 1457275 |

DAF 95

V/Control Auxiliar caja cambios / Pneumatic control of auxiliar gear valve



| REF. AIR-FREN | REF. RENAULT |
|---------------|--------------|
| 10.6735.00 | 5000673571 |

Electroválvula / Electrovalve
Kit reparación / Repair kit

| REF. AIR-FREN | REF. WABCO | REF. AIR-FREN | REF. SCANIA |
|---------------|---------------|---------------|---------------|
| 10.4720.00 | 472.002.302.0 | 10.R4720 | 472.002.009.2 |

IVECO, MAN, MERCEDES

Kit reparación / Repair kit

| REF. AIR-FREN | REF. WABCO | REF. AIR-FREN | REF. WABCO |
|---------------|---------------|---------------|---------------|
| 10.4730.00 | 472.017.480.0 | 10.R4730 | 472.017.000.2 |

IVECO

Kit reparación / Repair kit

| REF. AIR-FREN | REF. BOSCH | REF. AIR-FREN | REF. BOSCH |
|---------------|--------------------------------|---------------|-------------|
| 10.4740.00 | 0 481 500 101 0 481 500 102 | 10.R4740 | 33 40524012 |

MERCEDES

Kit reparación / Repair kit

| REF. AIR-FREN | REF. HALDEX | REF. AIR-FREN | REF. HALDEX |
|---------------|-------------|---------------|-------------|
| 10.3380.00 | 338 050 101 | 10.R3380 | 950 338 022 |

VOLVO

REF. AIR-FREN
REF. SCANIA

10.3034.70

 303470
1413047

SCANIA



REF. AIR-FREN

REF. SCANIA

10.2132.50

1421325

SCANIA

Electroválvula 24 volt / Electrovalve



REF. AIR-FREN

REF. WABCO

10.4750.00

472.123.108.0

DAF, MAN, IVECO, MERCEDES, RENAULT



REF. AIR-FREN

REF. WABCO

10.4750.10

472.100.101.0

MERCEDES, MAN, IVECO

Válvula control 5/2 vías / Control valve

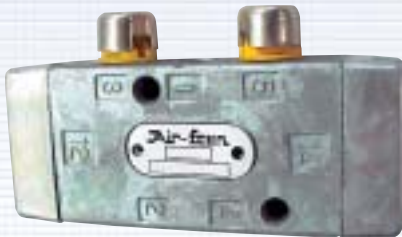

REF. AIR-FREN

REF. WABCO

10.0030.02

571.003.002.0

10.0030.04

571.003.104.0

DAF, IVECO, MAN, VOLVO, RENAULT

Válvula control direccional neumática / Directional control valve



REF. AIR-FREN

REF. WABCO

10.9640.00

964.001.002.0

DAF, IVECO, VOLVO, SCANIA, RENAULT, MAN

Cilindro corte de fuel / Fuel shut off cylinder

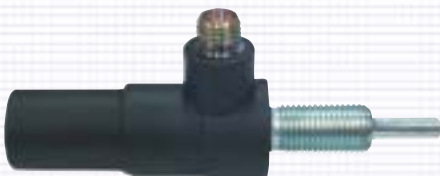

REF. AIR-FREN

REF. WABCO

10.2001.00

421.444.020.0

DAF, MAN, MERCEDES

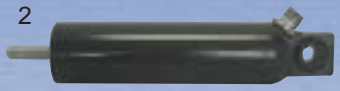

Cilindros de trabajo / Control cylinder

| REF. AIR-FREN | REF. KNORR | FIG. |
|---------------|------------|------|
| 10.265653 | SZ-1115 | 1 |
| 10.275653 | SZ-1159 | 1 |
| 10.285654 | SZ-1114 | 2 |
| 10.1878.25 | SZ-1166 | 3 |

MERCEDES, IVECO, MAN



| REF. AIR-FREN | REF. WABCO |
|---------------|---------------|
| 10.1883.20 | 421.411.020.0 |

MERCEDES



| REF. AIR-FREN | REF. IVECO |
|---------------|------------|
| 10.772.642 | 772.642 |

IVECO, PEGASO



| REF. AIR-FREN | REF. KNORR |
|---------------|------------|
| 10.1883.90 | SZ-1190 |

MERCEDES

Cilindro doble efecto / Double acting cylinder



Kit reparación / Repair kit

| REF. AIR-FREN | REF. WABCO | REF. AIR-FREN | REF. WABCO |
|---------------|---------------|---------------|---------------|
| 10.1880.10 | 422.010.014.0 | 10.R1880 | 422.010.001.2 |

MERCEDES, ZF, RENAULT

Cilindro doble efecto / Double acting cylinder



Kit reparación / Repair kit

| REF. AIR-FREN | REF. WABCO | REF. AIR-FREN | REF. WABCO |
|---------------|---------------|---------------|---------------|
| 10.1880.20 | 422.010.012.0 | 10.R1880 | 422.010.001.2 |

MERCEDES, ZF



| REF. AIR-FREN | REF. WABCO |
|---------------|---------------|
| 10.1883.40 | 421.411.301.0 |

DAF



| REF. AIR-FREN | REF. WABCO |
|---------------|---------------|
| 10.1883.50 | 421.411.025.0 |

MERCEDES, DAF, MAN



| REF. AIR-FREN | REF. WABCO |
|---------------|---------------|
| 10.1883.70 | 421.412.000.0 |

MERCEDES



| REF. AIR-FREN | REF. IVECO |
|---------------|-------------------------------------|
| 10.1883.75 | 4205 2729 4204 2638 4102 2031 |

IVECO; Technomatic Ref. 477



| REF. AIR-FREN | REF. IVECO |
|---------------|------------------------|
| 10.1883.80 | 0798 1576 4102 2032 |

DAF, IVECO; Technomatic Ref. 1558



| REF. AIR-FREN | REF. MAN |
|---------------|---------------|
| 10.1883.85 | 81 15701 6080 |

MAN; Technomatic Ref. 447

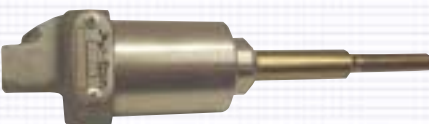

| REF. AIR-FREN | REF. WABCO |
|---------------|------------|
| 10.786.653 | 460.833.0 |

Cilindro de Trabajo / Control cylinder



| REF. AIR-FREN | REF. MAN |
|---------------|--|
| 10.1883.30 | 81 15701 61 12 81 15701 60 79 81 15701 60 99 |

MAN



| REF. AIR-FREN | REF. IVECO |
|---------------|----------------------|
| 10.775.275 | 775.275 500006424 |

IVECO

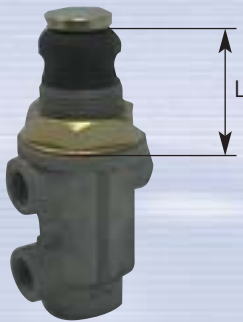

Válvulas 3/2 vías / Directional control valve

| REF. AIR-FREN | REF. WABCO |
|---------------|---------------|
| 10.559001 | 463.013.112.0 |

MERCEDES, L=37,9 mm



| REF. AIR-FREN | REF. WABCO |
|---------------|---------------|
| 10.559002 | 463.013.114.0 |

MERCEDES, L=95,6 mm



| REF. AIR-FREN | REF. WABCO |
|---------------|---------------|
| 10.559003 | 463.013.110.0 |

MERCEDES, L=46,9 mm



| REF. AIR-FREN | REF. WABCO |
|---------------|---------------|
| 10.559004 | 463.013.200.0 |

MERCEDES ACTROS, L= 41 mm



| REF. AIR-FREN | REF. WABCO |
|---------------|---------------|
| 10.559005 | 463.013.210.0 |

DAF, MERCEDES



| REF. AIR-FREN | REF. WABCO |
|---------------|---------------|
| 10.559006 | 463.022.020.0 |

DAF, VOLVO



| REF. AIR-FREN | REF. WABCO |
|---------------|---------------|
| 10.559007 | 463.037.001.0 |

DAF, MERCEDES



| REF. AIR-FREN | REF. WABCO |
|---------------|---------------|
| 10.8400.00 | 463.084.000.0 |

DAF, SCANIA, BPW

CARTUCHO SECADOR
AIR DRYER FILTER
FILTRE DÉSHYDRATEUR



Filtro de tubería / Air line filter

| REF. AIR-FREN | REF. WABCO |
|---------------|---------------|
| 10.930.930 | 432.500.000.0 |

MERCEDES, DAF, MAN



Válvula de purga pilotada / Drain valve

Kit reparación / Repair kit

| REF. AIR-FREN | REF. WABCO | REF. AIR-FREN | REF. WABCO |
|---------------|---------------|---------------|---------------|
| 10.055527 | 434.300.000.0 | 10.R430527 | 434.300.000.2 |

MERCEDES, DAF, MAN



Válvula descarga rápida / Quick release valve

Kit reparación / Repair kit

| REF. AIR-FREN | REF. WABCO | REF. AIR-FREN | REF. WABCO |
|---------------|---------------|---------------|---------------|
| 10.543002 | 973.500.000.0 | 10.R3350 | 973.500.000.2 |

SEMIRREMOLQUES



| REF. AIR-FREN | REF. BENDIX | MODELO / MODEL |
|---------------|-------------|----------------|
| 10.543022 | 229859 | QR-1 |
| 10.543032 | 229860 | |
| 10.543042 | 229813 | |
| 10.543092 | 229814 | |



| REF. AIR-FREN | REF. BENDIX | MODELO / MODEL |
|---------------|-------------|----------------|
| 10.543062 | 229507 | LQ-2 |
| 10.543072 | 229509 | |



| REF. AIR-FREN | REF. WABCO |
|---------------|---------------|
| 10.543082 | 973.500.038.0 |



Válvula escape rápido QR-1C / Quick release valve

| REF. AIR-FREN | REF. BENDIX |
|---------------|-------------|
| 10.543052 | 289714 |



Válvula escape rápido QRN / Quick release valve

| REF. AIR-FREN | REF. BENDIX |
|---------------|-------------|
| 10.543102 | 065066 |



Válvula escape rápido QRN / Quick release valve

| REF. AIR-FREN | REF. BENDIX |
|---------------|-------------|
| 10.543112 | 065067 |



Válvula compensadora / Valve

| | | Kit reparación / Repair kit | |
|---------------|---------------|-----------------------------|---------------|
| REF. AIR-FREN | REF. WABCO | REF. AIR-FREN | REF. WABCO |
| 10.543012 | 975.001.000.0 | 10.R543012 | 975.001.000.2 |

MERCEDES, BPW, IVECO, NEOPLAN

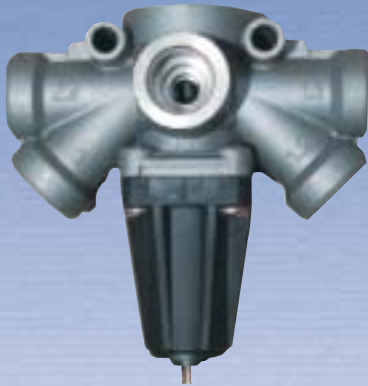
Limitador de presión / Pressure limiting valve

| REF. AIR-FREN | REF. WABCO |
|---------------|---------------|
| 10.5010.00 | 475.010.400.0 |

| Kit reparación / Repair kit | |
|-----------------------------|---------------|
| REF. AIR-FREN | REF. WABCO |
| 10.R5010 | 475.010.002.2 |

DAF, MAN

Limitador de presión / Pressure limiting valve

| REF. AIR-FREN | REF. WABCO |
|---------------|---------------|
| 10.5410.00 | 475.010.200.0 |

| Kit reparación / Repair kit | |
|-----------------------------|---------------|
| REF. AIR-FREN | REF. WABCO |
| 10.R5410 | 475.010.001.2 |

Limitador de presión / Pressure limiting valve

| REF. AIR-FREN | REF. BOSCH |
|---------------|---------------|
| 10.5310.90 | 0 481 009 026 |

| Kit reparación / Repair kit | |
|-----------------------------|---------------|
| REF. AIR-FREN | REF. BOSCH |
| 10.R5320 | 1 487 010 221 |

DAF, MAN, SCANIA, VOLVO; M22 X 150

Limitador de presión / Pressure limiting valve

| REF. AIR-FREN | REF. BOSCH |
|---------------|--------------------------------|
| 10.5310.100 | 0 481 009 029 0 481 009 039 |

| Kit reparación / Repair kit | |
|-----------------------------|---------------|
| REF. AIR-FREN | REF. BOSCH |
| 10.R5320 | 1 487 010 221 |

MERCEDES; M16 X 150



Válvula limitadora / Pressure limiting valve

| REF. AIR-FREN | | REF. WABCO | | Kit reparación / Repair kit | |
|---------------|---------------|---------------|---------------|-----------------------------|------------|
| REF. AIR-FREN | REF. WABCO | REF. AIR-FREN | REF. WABCO | REF. AIR-FREN | REF. WABCO |
| 10.5310.80 | 475.015.001.0 | 10.R5310 | 475.015.001.2 | | |

MERCEDES, DEUTZ, MAN



Válvula limitadora / Pressure limiting valve

| REF. AIR-FREN | | REF. WABCO | | Kit reparación / Repair kit | |
|---------------|---------------|---------------|---------------|-----------------------------|------------|
| REF. AIR-FREN | REF. WABCO | REF. AIR-FREN | REF. WABCO | REF. AIR-FREN | REF. WABCO |
| 10.5210.10 | 475.010.002.0 | 10.R5210 | 475.010.000.2 | | |
| 10.5210.60 | 475.010.013.0 | 10.R5210 | 475.010.000.2 | | |
| 10.5210.80 | 475.010.006.0 | 10.R5210 | 475.010.000.2 | | |

MERCEDES, VOLVO, DAF, MAN, SCANIA, IVECO



Válvula de seguridad / Safety valve

| REF. AIR-FREN | REF. TACA | REF. AIR-FREN | REF. WABCO | PRESIÓN |
|---------------|------------------------|---------------|------------|----------|
| 10.2440.19 | 244.019.2 (3,5 bar) | 10.2440.20 | 460.497.4 | 7,5 bar |
| | | 10.2440.21 | 460.396.0 | 8,0 bar |
| | | 10.2440.22 | 460.403.1 | 8,2 bar |
| | | 10.2440.23 | 460.444.2 | 11,0 bar |

RVI M22x1,5

RVI, IVECO, PEGASO



Válvula de seguridad / Safety valve

| REF. AIR-FREN | REF. BENDIX |
|---------------|-------------|
| 10.763.775 | 118007 |

IVECO, PEGASO, M16x1,5 mm; 9,3 bar



Válvula de seguridad / Safety valve ST-1

| REF. AIR-FREN | REF. BENDIX |
|---------------|-------------|
| 10.2440.30 | 205105 |



Válvula de seguridad / Safety valve

| Kit reparación / Repair kit | | | |
|-----------------------------|-----------|---------------|----------------|
| REF. AIR-FREN | REF. TACA | REF. AIR-FREN | REF. TACA |
| 10.3450.10 | 244.852.0 | 10.R3450 | 244.852.01.100 |

RVI, IVECO, PEGASO, NISSAN, MERCEDES, MAN



Válvula de rebose / Pressure regulator

| Kit reparación / Repair kit | | | |
|-----------------------------|---------------|---------------|---------------|
| REF. AIR-FREN | REF. WABCO | REF. AIR-FREN | REF. WABCO |
| 10.2950.05 | 434.100.021.0 | 10.R1965 | 434.100.000.2 |
| 10.2950.50 | 434.100.022.0 | 10.R1965 | 434.100.000.2 |
| 10.2950.60 | 434.100.023.0 | 10.R1965 | 434.100.000.2 |
| 10.2950.30 | 434.100.024.0 | 10.R1965 | 434.100.000.2 |
| 10.2950.10 | 434.100.025.0 | 10.R1965 | 434.100.000.2 |
| 10.2950.15 | 434.100.027.0 | 10.R1965 | 434.100.000.2 |
| 10.2950.70 | 434.100.028.0 | 10.R1965 | 434.100.000.2 |
| 10.2950.40 | 434.100.029.0 | 10.R1965 | 434.100.000.2 |
| 10.2950.00 | 434.100.033.0 | 10.R1965 | 434.100.000.2 |
| 10.2950.25 | 434.100.044.0 | 10.R1965 | 434.100.000.2 |
| 10.2950.35 | 434.100.122.0 | 10.R1965 | 434.100.000.2 |
| 10.2950.75 | 434.100.124.0 | 10.R1965 | 434.100.000.2 |
| 10.2950.90 | 434.100.125.0 | 10.R1965 | 434.100.000.2 |
| 10.2950.20 | 434.100.126.0 | 10.R1965 | 434.100.000.2 |
| 10.2950.45 | 434.100.129.0 | 10.R1965 | 434.100.000.2 |
| 10.2950.55 | 434.100.130.0 | 10.R1965 | 434.100.000.2 |
| 10.2950.65 | 434.100.136.0 | 10.R1965 | 434.100.000.2 |
| 10.2950.80 | 434.100.200.0 | 10.R1965 | 434.100.000.2 |

VOLVO, DAF, MAN, MERCEDES, SCANIA, IVECO, PEGASO



Llave de paso / Cut cock

| Kit reparación / Repair kit | | | |
|-----------------------------|---------------|---------------|---------------|
| REF. AIR-FREN | REF. WABCO | REF. AIR-FREN | REF. WABCO |
| 10.4395.10 | 452.002.100.0 | 10.R3800E | 452.002.009.2 |
| 10.4395.20 | 452.002.107.0 | 10.R3800E | 452.002.009.2 |

IVECO, PEGASO



Válvula de retención / Check valve

| REF. AIR-FREN | REF. WABCO |
|---------------|---------------|
| 10.2440.15 | 434.014.000.0 |

IVECO, PEGASO, MAN, VOLVO, SCANIA, MERCEDES, DAF



Válvula doble retención / Double check valve

| REF. AIR-FREN | REF. WABCO |
|---------------|---------------|
| 10.3200.30 | 434.208.029.0 |

IVECO, PEGASO, MAN, MERCEDES



Válvula doble retención / Double check valve

| REF. AIR-FREN | REF. WABCO |
|---------------|--------------------------------|
| 10.3200.60 | 434.202.100.0 434.202.000.0 |

DAF, MAN, IVECO, MERCEDES, SCANIA



Grifo de purga manual / Emergency cock

| REF. AIR-FREN | REF. WABCO |
|---------------|---------------|
| 10.4375.10 | 934.300.001.0 |

MAN, MERCEDES, VOLVO, SCANIA, RVI, IVECO, DAF



Válvula de purga automática / Automatic emergency cock

| | | Kit reparación / Repair kit | |
|---------------|---------------|-----------------------------|---------------|
| REF. AIR-FREN | REF. WABCO | REF. AIR-FREN | REF. WABCO |
| 10.8321.00 | 934.301.000.0 | 10.R8321 | 934.301.000.2 |

MAN, MERCEDES, VOLVO, SCANIA, DAF, RVI, IVECO, PEGASO



Válvula de purga automática / Automatic emergency cock

| REF. AIR-FREN | REF. KNORR |
|---------------|------------|
| 10.8321.10 | EE-4106 |

MAN, MERCEDES, VOLVO, SCANIA

Válvula de Mando / Control valve
REF. AIR-FREN
REF. BENDIX

10.5676.00

114.004

IVECO, PEGASO

Válvula de Mando / Control valve
REF. AIR-FREN
REF. BENDIX

10.5676.20

280904

Dispositivo anticongelante / Antifreezer
Kit reparación / Repair kit
REF. AIR-FREN
REF. WABCO
REF. AIR-FREN
REF. WABCO

10.8210.00

432.199.010.0

10.R8210

432.199.004.2

IVECO, PEGASO

Válvula control direccional 3/2 vías / 3/2 directional control valve
REF. AIR-FREN
REF. WABCO

10.1881.10

463.036.000.0

MERCEDES, DAF, VOLVO, MAN, BPW

Válvula control direccional 3/2 vías / 3/2 directional control valve
REF. AIR-FREN
REF. WABCO

10.1881.20

463.036.005.0

DAF, MERCEDES

Válvula Retención / Valve
REF. AIR-FREN
REF. BOSCH

10.100006

0 500 100 006

MERCEDES, SCANIA, IVECO



Válvula de Mando / Control valve

| REF. AIR-FREN | REF. WABCO |
|---------------|---------------|
| 10.5018.00 | 472.195.018.0 |

IVECO, VOLVO, SCANIA



Cable de conexión / Electrical connector

| REF. AIR-FREN | REF. WABCO |
|---------------|---------------|
| 10.8946.00 | 894.601.132.2 |



Válvula de control solenoide ABS / Control valve

| REF. AIR-FREN | REF. WABCO |
|---------------|--------------------------------|
| 10.5018.10 | 472.195.004.0 472.195.921.2 |

MERCEDES, DAF, VOLVO, SCANIA, IVECO, RENAULT

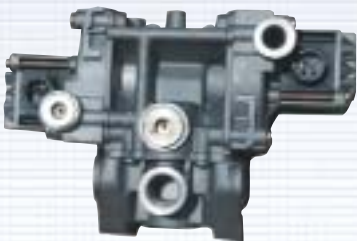

Modulador ABS / ABS Modulator

| REF. AIR-FREN | REF. WABCO |
|---------------|---------------|
| 10.5040.00 | 472.195.041.0 |

DAF, RENAULT

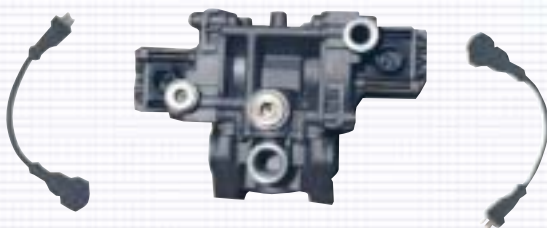

| REF. AIR-FREN | REF. WABCO |
|---------------|---------------|
| 10.5040.10 | 472.195.040.0 |

DAF, RENAULT



Filtro de purga / Filter

| REF. AIR-FREN | REF. WABCO |
|---------------|--------------------------------|
| 10.511000 | 432.511.000.0 432.511.001.0 |

MERCEDES

Modulador ABS / ABS Modulator

| REF. AIR-FREN | REF. HALDEX |
|---------------|-------------|
| 10.3640.00 | 950 364 047 |

DAF, RENAULT

Modulador ABS / ABS Modulator

| REF. AIR-FREN | REF. WABCO |
|---------------|---------------|
| 10.5031.00 | 472.195.031.0 |

RENAULT

Modulador ABS con cable / ABS Modulator

| REF. AIR-FREN | REF. WABCO |
|---------------|---------------|
| 10.5031.10 | 472.195.020.0 |

DAF

Sensor ABS / ABS Sensor

| REF. AIR-FREN | REF. WABCO |
|---------------|---------------|
| 10.4410.40 | 441.032.921.2 |

DAF, RENAULT

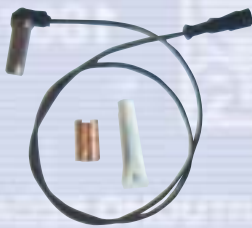
Sensor ABS / ABS Sensor

| REF. AIR-FREN | REF. WABCO |
|---------------|---------------|
| 10.4410.100 | 441.032.922.2 |

DAF, RENAULT, SCANIA

Sensor EBS / EBS Sensor

| REF. AIR-FREN | REF. WABCO |
|---------------|---------------|
| 10.4420.40 | 441.032.443.0 |

BPW

Sensor EBS / EBS Sensor

| REF. AIR-FREN | REF. WABCO |
|---------------|---------------|
| 10.4420.100 | 441.032.573.0 |

DAF



Cable modulator ABS / ABS Electrical connector

| REF. AIR-FREN | REF. WABCO |
|---------------|---------------|
| 10.4494.10 | 449.411.005.0 |

DAF



Cable modulator ABS / ABS Electrical connector

| REF. AIR-FREN | REF. WABCO |
|---------------|---------------|
| 10.4494.20 | 449.444.022.0 |

DAF



Fuelle suspensión Cabina Scania / Scania air bellows

| REF. AIR-FREN | REF. SCANIA |
|---------------|--------------------|
| 10.3819.00 | 1476415 1381919 |

DAF



Fuelle suspensión Cabina Scania / Scania air bellows

| REF. AIR-FREN | REF. SCANIA |
|---------------|-------------|
| 10.4984.00 | 1349840 |

SCANIA



Válvula de mando caja cambios / KNOB

| REF. AIR-FREN | REF. SCANIA |
|---------------|-------------|
| 10.8299.70 | 1482997 |

SCANIA

Válvula Protección / Pressure protection valve

| REF. AIR-FREN | REF. BENDIX | MODELO / MODEL |
|---------------|-------------|----------------|
| 10.2865.00 | 286500 | PR-4 |

Válvula Control Trailer / Dash control valve

| REF. AIR-FREN | REF. BENDIX | MODELO / MODEL |
|---------------|-------------|----------------|
| 10.2882.00 | 288239 | PP-7 |
| 10.2882.10 | 288241 | |

Válvula protección / Pressure protection valve

| REF. AIR-FREN | REF. NEWAY |
|---------------|------------|
| 10.9055.00 | 90554107 |

Válvula Moduladora / Modulating relay valve

| REF. AIR-FREN | REF. BENDIX | MODELO / MODEL |
|---------------|-------------|----------------|
| 10.1030.00 | 103081 | R-7 |

Válvula doble retención / Double check valve

| REF. AIR-FREN | REF. WABCO |
|---------------|---------------|
| 10.3200.50 | 434.500.003.0 |

DAF, MAN, IVECO, MB

Válvula protección / Pressure protection valve

| REF. AIR-FREN | REF. BENDIX | MODELO / MODEL |
|---------------|-------------|----------------|
| 10.2772.00 | 277227 | PR-2 |



Válvula / Multifunction valve

| REF. AIR-FREN | REF. MIDLAND |
|---------------|--------------|
| 10.2600.00 | KN-26000 |



Válvula moduladora de control / Modulating Control Valve

| REF. AIR-FREN | REF. BENDIX | MODELO / MODEL |
|---------------|-------------|----------------|
| 10.2823.81 | 282381 | TC-4 |



Válvula drenaje / Automatic drain valve

| REF. AIR-FREN | REF. BENDIX | MODELO / MODEL |
|---------------|-------------|----------------|
| 10.2819.00 | 281923 | DV-2 |



Válvula drenaje / Automatic drain valve

| REF. AIR-FREN | REF. BENDIX | MODELO / MODEL |
|---------------|-------------|----------------|
| 10.2844.00 | 284412 | DV-2 |



Indicador baja presión / Low pressure indicator

| REF. AIR-FREN | REF. BENDIX | MODELO / MODEL |
|---------------|-------------|----------------|
| 10.2794.00 | 279472 | LP-3 |
| 10.2287.50 | 228750 | |



Indicador de freno / Brake light switch

| REF. AIR-FREN | REF. BENDIX | MODELO / MODEL |
|---------------|-------------|----------------|
| 10.2286.00 | 228600 | SL-4 |

Válvula de Mando / Control valve

| REF. AIR-FREN | REF. BENDIX | MODELO / MODEL |
|---------------|-------------|----------------|
| 10.5676.10 | 276635 | TW-4 |

Válvula Control Suspensión / Air suspension control valve

| REF. AIR-FREN | REF. HALDEX |
|---------------|-------------|
| 10.9005.10 | 90054079 |

Válvula Interruptor / Switch control valve

| REF. AIR-FREN | REF. HALDEX |
|---------------|-------------|
| 10.9005.15 | 90054088 |

Electroválvula / Solenoid directional control valve

| REF. AIR-FREN | REF. HALDEX |
|---------------|-------------|
| 10.9005.20 | 90054075 |

Electroválvula / Solenoid directional control valve

| REF. AIR-FREN | REF. HALDEX |
|---------------|-------------|
| 10.9005.25 | 90054074 |

Electroválvula / Solenoid directional control valve

| REF. AIR-FREN | REF. HALDEX |
|---------------|-------------|
| 10.9005.30 | 90054076 |



Cabezas de acoplamiento / Palm coupling

Normales / Normal

| REF. AIR-FREN | REF. WABCO | MÉTRICA | COLOR |
|---------------|---------------|---------|-------|
| 10.579001 | 952.200.021.0 | 16 | R |
| 10.579002 | 952.200.022.0 | 16 | A |
| 10.579003 | 952.200.037.0 | 22 | R |
| 10.579004 | 952.200.034.0 | 22 | A |

R= rojas / red

A= amarillas / yellow



Normales / Normal

| REF. AIR-FREN | REF. WABCO | MÉTRICA | COLOR |
|---------------|---------------|---------|-------|
| 10.579007 | - | 16 | R |
| 10.579008 | - | 16 | A |
| 10.579009 | 952.000.021.0 | 22 | R |
| 10.579010 | 952.000.022.0 | 22 | A |

R= rojas / red

A= amarillas / yellow

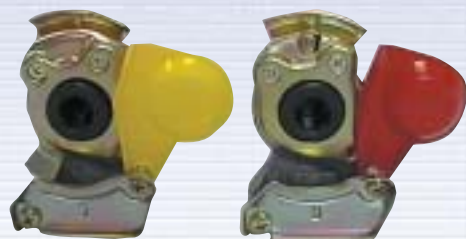

Automáticas / Automatic

| REF. AIR-FREN | REF. WABCO | MÉTRICA | COLOR |
|---------------|---------------|---------|-------|
| 10.579005 | 952.200.221.0 | 16 | R |
| 10.579006 | 952.200.222.0 | 16 | A |
| 10.579011 | 452.200.211.0 | 22 | R |
| 10.579012 | 452.200.212.0 | 22 | A |

R= rojas / red

A= amarillas / yellow



Automáticas / Automatic

| REF. AIR-FREN | REF. WABCO | MÉTRICA | COLOR |
|---------------|---------------|---------|-------|
| 10.579013 | 952.200.210.0 | 16 | R |

R= rojas / red



Conexiones de aire / Air coil

| REF. AIR-FREN | REF. WABCO | MÉTRICA | COLOR |
|---------------|---------------|---------|-------|
| 10.3500.16A | 452.711.012.0 | 16 | A |
| 10.3500.16R | 452.711.011.0 | 16 | R |
| 10.3500.22A | 452.711.002.0 | 22 | A |
| 10.3500.22R | 452.711.001.0 | 22 | R |
| 10.3500.18A | 452.711.022.0 | 18 | A |
| 10.3500.18R | 452.711.021.0 | 18 | R |

DAF, MAN, SCANIA, VOLVO, RVI, MERCEDES

A= amarillas / yellow

R= rojas / red

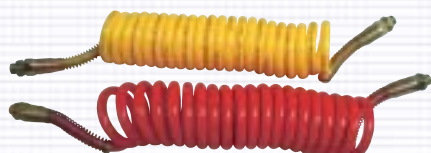

Conexiones de aire (Poliuretano) / Air coil

| REF. AIR-FREN | MÉTRICA | COLOR |
|---------------|---------|-------|
| 10.3500.16AP | 16 | A |
| 10.3500.16RP | 16 | R |

R= rojas / red

A= amarillas / yellow



Cabeza acoplamiento Duo-Matic / Quick coupling

| REF. AIR-FREN | REF. WABCO |
|---------------|---------------|
| 10.579014 | 452.802.009.0 |

DAF, MAN, MERCEDES, EVOBUS



Cabeza acoplamiento Duo-Matic / Quick coupling

| REF. AIR-FREN | REF. WABCO |
|---------------|---------------|
| 10.579015 | 452.804.012.0 |

DAF, MERCEDES, SCANIA, VOLVO, EVOBUS



Cabeza acoplamiento para remolques con filtro / Coupling heads standar with line filter

| REF. AIR-FREN | REF. WABCO | MÉTRICA | COLOR |
|---------------|---------------|---------|-------|
| 10.579016 | 952.201.002.0 | 16 | R |
| 10.579017 | 952.201.001.0 | 16 | A |

R= rojas / red

A= amarillas / yellow

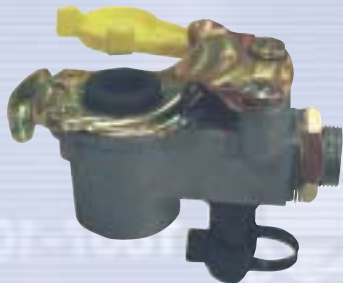

Cabeza acoplamiento para remolques con filtro / Coupling heads standar with line filter

| REF. AIR-FREN | REF. WABCO | MÉTRICA | COLOR |
|---------------|---------------|---------|-------|
| 10.579018 | 952.201.007.0 | 16 | A |

Con conector de test / with test coupling

A= amarillas / yellow



Cabeza acoplamiento para remolques con filtro / Coupling heads standar with line filter

| REF. AIR-FREN | REF. WABCO | MÉTRICA | COLOR |
|---------------|---------------|---------|-------|
| 10.579019 | 952.201.004.0 | 16 | R |
| 10.579020 | 952.201.003.0 | 16 | A |

R= rojas / red

A= amarillas / yellow



Cabeza acoplamiento para remolques con filtro / Coupling heads standar with line filter

| REF. AIR-FREN | REF. WABCO | MÉTRICA | COLOR |
|---------------|---------------|---------|-------|
| 10.579021 | 952.201.008.0 | 16 | A |

Con conector de test / with test coupling

A= amarillas / yellow



V/Anticongelante manual / Manual anti-freeze pump

| | | Kit reparación / Repair kit | |
|---------------|------------|-----------------------------|------------|
| REF. AIR-FREN | REF. BOSCH | REF. AIR-FREN | REF. BOSCH |
| 10.4510.00 | 0484451008 | 10.R4510 | 1487010199 |

MAN



V/Anticongelante manual / Manual anti-freeze pump

| | | Kit reparación / Repair kit | |
|---------------|------------|-----------------------------|------------|
| REF. AIR-FREN | REF. BOSCH | REF. AIR-FREN | REF. BOSCH |
| 10.4510.50 | 0484451013 | 10.R4510 | 1487010199 |

MAN



V/Anticongelante manual / Manual Anti-freeze pump

| REF. AIR-FREN | REF. KNORR |
|---------------|------------|
| 10.1100.00 | LA-1100 |

MAN, IVECO, MERCEDES



V/Anticongelante Automática / Automatic anti-freeze pump

| REF. AIR-FREN | REF. KNORR |
|---------------|--------------------|
| 10.4115.00 | LA-4115 LA-4129 |

MAN, IVECO, RENAULT, VOLVO

Válvula control / Control valve

| REF. AIR-FREN | REF. MIDLAND |
|---------------|----------------------|
| 10.2000.31 | KN-20030 KN-20031 |

Válvula control / Control valve

| REF. AIR-FREN | REF. BENDIX | MODELO / MODEL |
|--------------------------|--------------------|----------------|
| 10.2751.75 10.2876.00 | 276 566 287 600 | PP-1 |

Válvula Control / Control valve

| REF. AIR-FREN | REF. BENDIX | MODELO / MODEL |
|---------------|-------------|----------------|
| 10.2765.00 | 276567 | PP-1 |

Válvula de doble retención / Double check valve

| REF. AIR-FREN | REF. BENDIX | MODELO / MODEL |
|---------------|-------------|----------------|
| 10.3200.35 | 278 614 | DC-4 |

Válvula de doble retención / Double check valve

| REF. AIR-FREN | REF. BENDIX | MODELO / MODEL |
|---------------|-------------|----------------|
| 10.3200.45 | 281 459 | TR-3 |

Válvula de doble retención / Double check valve

| REF. AIR-FREN | REF. BENDIX | MODELO / MODEL |
|---------------|-------------|----------------|
| 10.3200.55 | 280 479 | DC-1 |

Válvula de retención / Check valve

| REF. AIR-FREN | REF. BENDIX | MODELO / MODEL |
|---------------|---|----------------|
| 10.2450.15 | 228 194 227 788 800 372 227 871 227 717 | SC-3 |



Silencioso / Silencer

| REF. AIR-FREN | REF. WABCO |
|---------------|---------------|
| 10.432407 | 432.407.070.0 |



Silencioso / Silencer

| REF. AIR-FREN | REF. WABCO |
|---------------|---------------|
| 10.432407.1 | 432.407.012.0 |



Silencioso / Silencer

| REF. AIR-FREN | REF. BOSCH |
|---------------|---------------|
| 10.484.210 | 0 484 210 001 |



Silencioso / Silencer

| REF. AIR-FREN | REF. WABCO |
|---------------|---------------|
| 10.975.303 | 975.303.530.2 |



Silencioso / Silencer

| REF. AIR-FREN | REF. WABCO |
|---------------|---------------|
| 10.975.303.1 | 975.303.531.2 |

Bomba embrague / Clutch unit
REF. AIR-FREN
REF. TACA
Kit reparación / Repair kit
REF. AIR-FREN
REF. TACA

10.2250.70

240.617.7

10.R2250

240.617.71.100

10.2650.10

241.617.0

10.R2650

241.617.01.100

RVI

Válvula refuerzo freno y embrague / Brake and clutch valve

REF. AIR-FREN
REF. TACA
Kit reparación / Repair kit
REF. AIR-FREN
REF. TACA

10.2550.00

240.757.0

10.R2550

240.757.01.100

10.2600.30

240.757.3

10.R2600

240.757.31.100

IVECO, PEGASO

Desfrenador / Trailer release valve
REF. AIR-FREN
REF. TACA
REF. AIR-FREN
REF. TACA

10.2458.48

245.848.0

10.R7250

245.848.01.100

SEMIRREMOLQUES

Cilindro ayuda embrague / Cylinder



| REF. AIR-FREN | | REF. TACA | | Kit reparación / Repair kit | |
|---------------|-----------|---------------|----------------|-----------------------------|-----------|
| REF. AIR-FREN | REF. TACA | REF. AIR-FREN | REF. TACA | REF. AIR-FREN | REF. TACA |
| 10.7010.00 | 267.010.0 | 10.R4000 | 267.010.41.100 | | |
| 10.7010.10 | 267.010.1 | 10.R3950 | 267.010.11.100 | | |
| 10.7010.40 | 267.010.4 | 10.R4000 | 267.010.41.100 | | |
| 10.7010.60 | 267.010.6 | 10.R4050 | 267.010.61.100 | | |
| 10.7010.70 | 267.010.7 | 10.R3950 | 267.010.11.100 | | |

RVI, EBRO, NISSAN

Convertidor / Brake hidralic unit



| REF. AIR-FREN | | REF. TACA | | Kit reparación / Repair kit | |
|---------------|-----------|---------------|----------------|-----------------------------|-----------|
| REF. AIR-FREN | REF. TACA | REF. AIR-FREN | REF. TACA | REF. AIR-FREN | REF. TACA |
| 10.2670.12 | 267.012.3 | 10.R5750 | 267.012.41.100 | | |

EBRO, NISSAN

Convertidor / Brake hidraulic unit



| REF. AIR-FREN | | REF. TACA | | Kit reparación / Repair kit | |
|---------------|-----------|---------------|----------------|-----------------------------|-----------|
| REF. AIR-FREN | REF. TACA | REF. AIR-FREN | REF. TACA | REF. AIR-FREN | REF. TACA |
| 10.2670.16 | 267.012.6 | 10.R5750 | 267.012.41.100 | | |

EBRO, NISSAN

Válvula descarga rápida / Quick release valve
Kit reparación / Repair kit

| REF. AIR-FREN | REF. TACA | REF. AIR-FREN | REF. TACA |
|---------------|-----------|---------------|----------------|
| 10.3300.10 | 244.676.0 | 10.R3300 | 244.676.01.100 |

RVI, IVECO, PEGASO, NISSAN

Válvula de mando reductora / Pneumatic valve
Kit reparación / Repair kit

| REF. AIR-FREN | REF. TACA | REF. AIR-FREN | REF. TACA |
|---------------|-----------|---------------|----------------|
| 10.1950.10 | 240.110.1 | 10.R1950 | 240.110.71.100 |

RENAULT, IVECO, PEGASO

Válvula de pisón / Pneumatic valve
Kit reparación / Repair kit

| REF. AIR-FREN | REF. TACA | REF. AIR-FREN | REF. TACA |
|---------------|-----------|---------------|----------------|
| 10.2405.55 | 240.555.0 | 10.R2150 | 240.555.01.100 |

RENAULT

Válvula de mando neumática / Pneumatic valve
Kit reparación / Repair kit

| REF. AIR-FREN | REF. TACA | REF. AIR-FREN | REF. TACA |
|---------------|-----------|---------------|----------------|
| 10.2400.13 | 240.001.3 | 10.R6350 | 240.001.01.100 |

RENAULT

Cilindro de comando / Cylinder

| REF. AIR-FREN | REF. TACA |
|---------------|-----------|
| 10.235.030.0 | 235.030.0 |

RENAULT

11

**SOLO KITS
DE REPARACIÓN**
ONLY REPAIR KITS



Secador de aire LA- 6705 / Air dryer

| KIT AIR-FREN | KIT KNORR |
|--------------|-----------|
| 11.R2901 | I-90121 |



Secador de aire LA- 6700 / Air dryer

| KIT AIR-FREN | KIT KNORR |
|--------------|-----------|
| 11.R2902 | I-90121/1 |



Secador de aire LA- 6200 / Air dryer

| KIT AIR-FREN | KIT KNORR |
|--------------|-----------|
| 11.R2903 | I-87917 |



Secador de aire LA- 6208 / Air dryer

| KIT AIR-FREN | KIT KNORR |
|--------------|-----------|
| 11.R2904 | I-87919 |



Regulador de presión 0481039... / Unloader valve

| KIT AIR-FREN | KIT BOSCH |
|--------------|------------|
| 11.R2905 | 1487010165 |



Regulador de pedal 0481064001 / Foot valve

| KIT AIR-FREN | KIT BOSCH |
|--------------|------------|
| 11.R2906 | 1487010178 |

Válvula de pedal MB-4636 / Foot valve
KIT AIR-FREN
KIT KNORR

11.R2907

I-83842

Válvula relé RE-1110 / Relay valve
KIT AIR-FREN
KIT KNORR

11.R2910

I-68094

Válvula relé RE-2221 / Relay valve
KIT AIR-FREN
KIT KNORR

11.R2911

I-67698

Válvula control remolque AB-2782 / Trailer control valve
KIT AIR-FREN
KIT KNORR

11.R2912

I-81234

Válvula cuadruple protección 0481062301
 Quadruple circuit protection valve

KIT AIR-FREN
KIT BOSCH

11.R2914

1487010234



Válvula cuadruple protección 0481062401

Quadruple circuit protection valve

| KIT AIR-FREN | KIT BOSCH |
|--------------|------------|
| 11.R2915 | 1487010237 |



Válvula control remolque AB-2835 / Trailer control valve

| KIT AIR-FREN | KIT KNORR |
|--------------|-----------|
| 11.R2916 | I-93262 |



Válvula anticongelante LA-4129 / Anti-freeze pump

| KIT AIR-FREN | KIT KNORR |
|--------------|-----------|
| 11.R2917 | I-85667 |



Válvula anticongelante 932.002.004.0 / Anti-freeze pump

| KIT AIR-FREN | KIT WABCO |
|--------------|---------------|
| 11.R2919 | 932.002.002.2 |



Actuador combinado 925.320.082.0 / Tristop

| KIT AIR-FREN | KIT WABCO | TIPO |
|--------------|---------------|-------|
| 11.R2920 | 925.320.001.2 | 24/24 |

Actuador combinado 925.320.401.0 / Tristop

| KIT AIR-FREN | KIT WABCO | TIPO |
|--------------|---------------|-------|
| 11.R2921 | 925.320.002.2 | 30/30 |

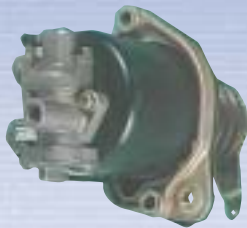
Servoembrague 970.051.147.0 / Clutch servo

| KIT AIR-FREN | KIT WABCO |
|--------------|---------------|
| 11.R2922 | 970.051.916.2 |

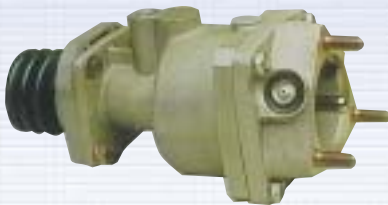
Servoembrague 462.012.100.0 / Clutch servo

| KIT AIR-FREN | KIT WABCO |
|--------------|---------------|
| 11.R2925 | 462.012.001.2 |

Servoembrague 462.012.101.0 / Repair kit

| KIT AIR-FREN | KIT WABCO |
|--------------|---------------|
| 11.R2926 | 462.012.002.2 |

Secador doble Man / MAN double air dryer

| KIT AIR-FREN | KIT WABCO |
|--------------|---------------|
| 11.R2929 | 432.431.000.2 |



Válvula de pedal / Foot valve

KIT AIR-FREN

KIT WABCO

11.R2931

461.315.900.2

461.315.901.2



Válvula control remolque / Relay valve

KIT AIR-FREN

KIT KNORR

11.R2932

I-85063

For: AB 2793; AB 2797; AB 2800



V/ Secador Bosch / Bosch air dryer

KIT AIR-FREN

KIT BOSCH

11.R2935

1 487 010 139



V/ Secador Bosch / Bosch air dryer

KIT AIR-FREN

KIT BOSCH

11.R2936

1 487 010 218



V/ en Función de la Carga / Load Sensing Valve

KIT AIR-FREN

KIT KNORR

11.R2937

I 84451/008

Para/For: BR-4415; BR-4437; BR-4440; BR-4452; BR-4453; BR-4464; BR-4466

V/ en Función de la Carga / Load Sensing Valve
KIT AIR-FREN
KIT KNORR

11.R2938

SEB 22187

Para/For: BR-4351; BR-4352

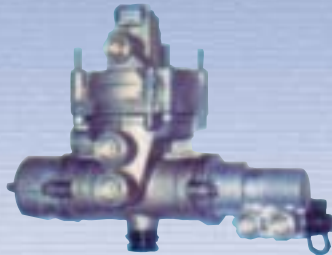
V/ en Función de la Carga / Load Sensing Valve
KIT AIR-FREN
KIT KNORR

11.R2939

II14588008

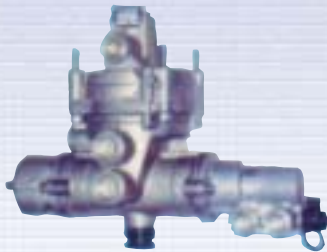
 Para/For: BR-5607; BR-5608; BR-5611; BR-5615;
BR-5616; BR-5619; BR-5633; BR-5643

V/ en Función de la Carga / Load Sensing Valve
KIT AIR-FREN
KIT KNORR

11.R2940

SEB 22188

Para/For: BR-5503; BR-5504; BR-5507; BR-5508

V/ en Función Carga 0481036101 / Load Sensing Valve
KIT AIR-FREN
KIT BOSCH

11.R2941

1487010098

Válvula pedal Iveco / Foot valve
KIT AIR-FREN
KIT IVECO

11.R2942

250-E21

Para/For: DX 70/DX 70-A/DX 70-C/DX-72

Válvula pedal 0481064701 / Foot valve
KIT AIR-FREN
KIT BOSCH

11.R2943

1487010219



Válvula de Mano HB-1154 / Hand brake valve

| KIT AIR-FREN | KIT KNORR |
|--------------|-----------|
| 11.R2944 | I-72290 |



Servoembrague 970.051.303.0 / Clutch servo unit

| KIT AIR-FREN | KIT WABCO |
|--------------|---------------|
| 11.R2945 | 970.051.953.2 |



Servoembrague 970.051.405.0 / Clutch servo unit

| REF. AIR-FREN | REF. WABCO |
|---------------|---------------|
| 11.R2946 | 970.051.949.2 |



Válvula de Pedal 461.499.000.0 / Foot valve

| KIT AIR-FREN | KIT WABCO |
|--------------|---------------|
| 11.R2951 | 461.499.000.2 |



Válvula Pedal Iveco / Foot Valve

| KIT AIR-FREN | KIT IVECO |
|--------------|-----------|
| 11.R2952 | 93190989 |



Válvula Pedal MB4710 / Foot Valve

| KIT AIR-FREN | KIT KNORR |
|--------------|-----------|
| 11.R2953 | I-76535 |



Válvula de mando caja cambios 463.049.000.0 / Hand valve

| KIT AIR-FREN | KIT WABCO |
|--------------|---------------|
| 11.R2956 | 463.049.000.2 |

Válvula de mando caja cambios 463.055.000.0 / Hand valve

| REF. AIR-FREN | REF. WABCO |
|---------------|---------------|
| 11.R2957 | 463.055.002.2 |

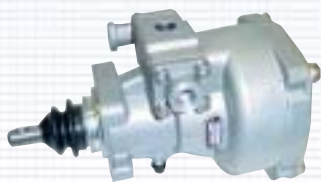
VOLVO FH

Servoembrague Renault / Clutch servo

| KIT AIR-FREN | KIT WABCO |
|--------------|--------------------------------|
| 11.R2958 | 720.216.000.8 720.204.000.8 |

Cilindro maestro / Master cylinder

| REF. AIR-FREN | REF. MERCEDES |
|---------------|---------------|
| 11.R2960 | 000 586 47 29 |

MERCEDES



| KIT AIR-FREN | KIT WABCO |
|--------------|---------------|
| 11.R2961 | 472.900.002.2 |



| KIT AIR-FREN | KIT WABCO |
|--------------|---------------|
| 11.R2962 | 472.900.005.2 |



| KIT AIR-FREN | KIT WABCO |
|--------------|---------------|
| 11.R2963 | 472.905.003.2 |



| KIT AIR-FREN | KIT WABCO |
|--------------|---------------|
| 11.R2964 | 472.905.004.2 |

Válvula relé proporcional 480.202.004.0 / Proportional Relay valve

| KIT AIR-FREN | KIT WABCO |
|--------------|-----------|
| 11.R2966 | - |

Válvula relé proporcional 480.204.001.0 / Proportional Relay valve

| KIT AIR-FREN | KIT WABCO |
|--------------|-----------|
| 11.R2967 | - |

Válvula relé emergencia 971.002.802.0 / Relay valve

| KIT AIR-FREN | KIT WABCO |
|--------------|-----------|
| 11.R2968 | - |

Válvula protección 4 circuitos AE-4604 / Circuit protection valve

| KIT AIR-FREN | REF. KNORR |
|--------------|----------------------|
| 11.R2969 | II 36011 II 36012 |

Válvula relé 973.011.050.0 / Relay valve

| KIT AIR-FREN | KIT WABCO |
|--------------|---------------|
| 11.R2970 | 973.011.002.2 |

For 973.011.0500; 973.011.201.0; 973.011.202.0



Servoembrague Ø100 460.806.8 - 461.443.4 / Clutch servo

| KIT AIR-FREN | KIT WABCO |
|--------------|-----------|
| 11.R100.00 | 402.835.8 |
| 11.R100.00 | 403.994.3 |



Servoembrague Ø65 460.375.5 - 460.719.3 / Clutch servo

| KIT AIR-FREN | KIT WABCO |
|--------------|-----------|
| 11.R65.00 | 401.586.6 |
| 11.R65.00 | 402.625.5 |



Regulador manual / Manual empty-load valve

| KIT AIR-FREN | KIT TACA | KIT GRAU |
|-----------------------|----------------|-------------|
| 11.R3700 11.R3700E | 245.232.01.100 | 950.352.003 |

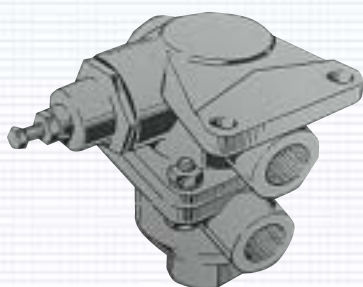

Válvula relé 244.640.0 / Relay valve

| KIT AIR-FREN | KIT TACA | KIT GRAU |
|----------------------|----------------|-------------|
| 11.R3250 11.R2750 | 244.640.01.100 | 950.351.004 |



Válvula amplificadora Taca 245.706.0 / Valve

| KIT AIR-FREN | KIT TACA |
|--------------|----------------|
| 11.R3750 | 245.706.01.100 |

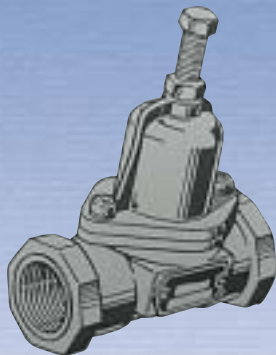
Válvula rebose 244.314.0 / Pressure regulator

| KIT AIR-FREN | KIT TACA |
|--------------|----------------|
| 11.R2950 | 244.314.01.100 |

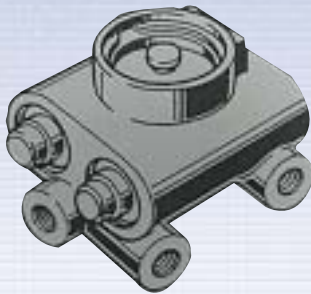
Válvula protección cuatro circuitos 244.549.0
 Circuit protection valve

| KIT AIR-FREN | KIT TACA |
|--------------|----------------|
| 11.R3150 | 244.549.01.100 |

Servodirección 540.070.1 / Hidraulic cylinder

| KIT AIR-FREN | KIT TACA |
|--------------|----------------|
| 11.R4150 | 540.070.11.100 |

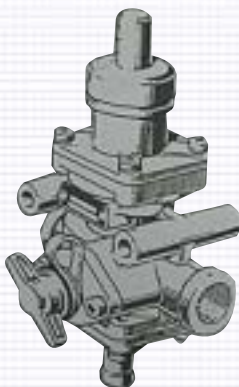
Válvula reguladora de presión 312.017.012 / Unloader valve

| KIT AIR-FREN | KIT GRAU |
|--------------|-------------|
| 11.R3650 | 950.312.007 |

12



BOMBAS DE AGUA
WATER PUMPS



| REF. AIR-FREN | REF. DAF |
|---------------|--------------------|
| 12.350.010 | CBU2148 CBU2396 |

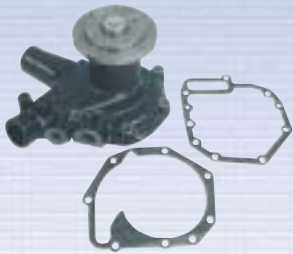

| REF. AIR-FREN | REF. DAF |
|---------------|--------------------|
| 12.350.015 | 0682263 0680217 |

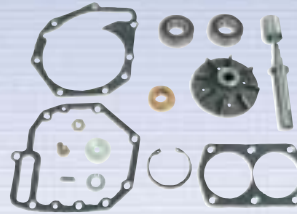

Kit reparación / Repair kit

| REF. AIR-FREN | REF. DAF |
|---------------|----------|
| 12.R350.015 | - |



| REF. AIR-FREN | REF. DAF |
|---------------|--------------------|
| 12.350.020 | 0682264 0624147 |

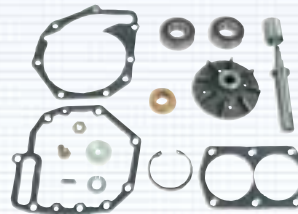

Kit reparación / Repair kit

| REF. AIR-FREN | REF. DAF |
|---------------|----------|
| 12.R350.015 | - |



| REF. AIR-FREN | REF. DAF |
|---------------|-------------------------------|
| 12.350.025 | 0682260 0517097 0506109 |

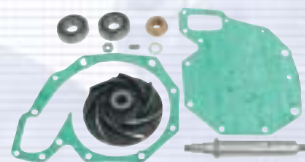

Kit reparación / Repair kit

| REF. AIR-FREN | REF. DAF |
|---------------|----------|
| 12.R350.025 | - |



Air-fren.si

BOMBAS DE AGUA /

WATER PUMPS

DAF



| REF. AIR-FREN | REF. DAF |
|---------------|--------------------|
| 12.350.030 | 0682262 0680156 |

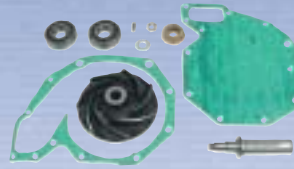

| Kit reparación / Repair kit | |
|-----------------------------|----------|
| REF. AIR-FREN | REF. DAF |
| 12.R350.030 | - |

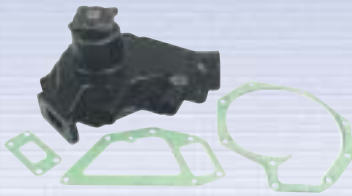

| REF. AIR-FREN | REF. DAF |
|---------------|-------------------------------|
| 12.350.035 | 0682968 0682258 0681653 |



| Kit reparación / Repair kit | |
|-----------------------------|----------|
| REF. AIR-FREN | REF. DAF |
| 12.R350.035 | - |

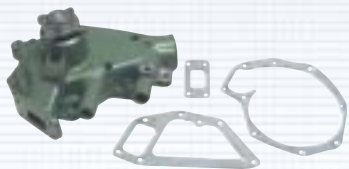

| REF. AIR-FREN | REF. DAF |
|---------------|----------|
| 12.350.040 | 682980 |



| Kit reparación / Repair kit | |
|-----------------------------|----------|
| REF. AIR-FREN | REF. DAF |
| 12.R350.040 | - |



| REF. AIR-FREN | REF. DAF |
|---------------|----------|
| 12.350.045 | 683225 |

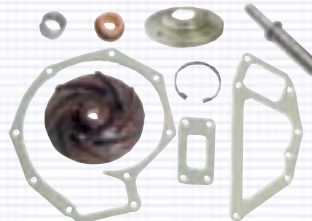

| Kit reparación / Repair kit | |
|-----------------------------|----------|
| REF. AIR-FREN | REF. DAF |
| 12.R350.045 | - |

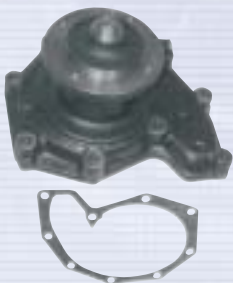

| REF. AIR-FREN | REF. DAF |
|---------------|----------|
| 12.350.050 | 682958 |



| REF. AIR-FREN | MODELO / MODEL | MOTOR / ENGINE |
|---------------|--|--|
| 12.350.010 | 600 800 1000 45 Todos los modelos / All the models 55 Todos los modelos / All the models | 4 Cilindros 3.9 6 Cilindros 5.9 |
| 12.350.015 | 2100 2300 2500 SB2300 SB2305 | DU 825 DHR 825 DHU 825 |
| 12.350.020 | SB2000 SB2005 2100 2300 2500 | DU 825 DHR 825 DHU 825 |
| 12.350.025 | 2800 3300 3600 (Con electroventilador / With electric fan) | DKS 1160 DKSE 1160 DKTS 1160 DKTD 1160 |
| 12.350.030 | 2800 3300 3600 | DKS 1160 DKSE 1160 DKTS 1160 DKTD 1160 |
| 12.350.035 | 80 Todos modelos / All the models 85 Todos modelos / All the models 95.330 95.360 95.400 95.430 | WS 242L /268L / 295 6 cyl. 11.6 L WS 242 L WS 268 L WS 295 WS 315 G |
| 12.350.040 | 80 85 95 | WS 315 L |
| 12.350.045 | XF85 XF95 | |
| 12.350.050 | 65 Todos los modelos / All the models 1300 1700 1900 2700 | 620 NS DNT/DNTD/DNS 620 DNT/DNTD/DNS 620 DNT/DNTD/DNS 620 DNT/DNTD/DNS 620 |



Air-fren SI

BOMBAS DE AGUA /

WATER PUMPS

IVECO



| REF. AIR-FREN | REF. IVECO |
|---------------|-----------------------|
| 12.360.010 | 500361919 99438900 |



| REF. AIR-FREN | REF. IVECO |
|---------------|------------|
| 12.360.015 | 93191101 |



| REF. AIR-FREN | REF. IVECO |
|---------------|------------|
| 12.360.020 | 4813370 |



| REF. AIR-FREN | REF. IVECO |
|---------------|------------|
| 12.360.025 | 98415831 |



| REF. AIR-FREN | REF. IVECO |
|---------------|------------|
| 12.360.030 | 4838676 |



| REF. AIR-FREN | REF. IVECO |
|---------------|------------|
|---------------|------------|

| | |
|------------|----------|
| 12.360.035 | 93190288 |
|------------|----------|

| | |
|----------|--|
| 93190288 | |
|----------|--|

Para/For IVECO water pump Ref. 61315468



| REF. AIR-FREN | REF. IVECO |
|---------------|------------|
|---------------|------------|

| | |
|------------|---------|
| 12.360.040 | 4752137 |
|------------|---------|

| | |
|---------|--|
| 4752137 | |
|---------|--|

Kit reparación / Repair kit



| REF. AIR-FREN | REF. IVECO |
|---------------|------------|
|---------------|------------|

| | |
|------------|----------|
| 12.360.045 | 99458098 |
|------------|----------|

| | |
|----------|--|
| 99458098 | |
|----------|--|



| REF. AIR-FREN | REF. IVECO |
|---------------|------------|
|---------------|------------|

| | |
|------------|----------|
| 12.360.085 | 42530032 |
|------------|----------|

| | |
|----------|--|
| 42530032 | |
|----------|--|

Kit reparación / Repair kit



| REF. AIR-FREN | REF. IVECO |
|---------------|------------|
|---------------|------------|

| | |
|------------|----------|
| 12.360.050 | 99458099 |
|------------|----------|

| | |
|----------|--|
| 99458099 | |
|----------|--|



| REF. AIR-FREN | REF. IVECO |
|---------------|------------|
|---------------|------------|

| | |
|------------|----------|
| 12.360.070 | 42530033 |
|------------|----------|

| | |
|----------|--|
| 42530033 | |
|----------|--|

Kit reparación / Repair kit



| REF. AIR-FREN | REF. IVECO |
|---------------|------------|
|---------------|------------|

| | |
|------------|----------|
| 12.360.055 | 98447661 |
|------------|----------|

| | |
|----------|--|
| 98447661 | |
|----------|--|



| REF. AIR-FREN | REF. IVECO |
|---------------|------------|
|---------------|------------|

| | |
|------------|-----------|
| 12.360.075 | 500350785 |
|------------|-----------|

| | |
|-----------|----------|
| 500350785 | 99445447 |
|-----------|----------|

IVECO



| REF. AIR-FREN | REF. IVECO |
|---------------|------------|
| 12.360.060 | 98439476 |

Kit reparación / Repair kit

| REF. AIR-FREN | REF. IVECO |
|---------------|----------------------|
| 12.360.090 | 42535615 42532082 |



| REF. AIR-FREN | REF. IVECO |
|---------------|------------|
| 12.360.065 | 98497115 |



| REF. AIR-FREN | REF. IVECO |
|---------------|-------------------------|
| 12.360.080 | 500.350.798 93190284 |

Para/For IVECO water pump Ref. 61321400

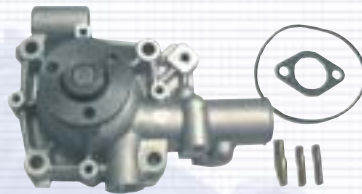

| REF. AIR-FREN | REF. IVECO |
|---------------|------------|
| 12.360.095 | 99440728 |



| REF. AIR-FREN | REF. IVECO |
|---------------|------------|
| 12.360.100 | 500300470 |

IVECO

| REF. AIR-FREN | MODELO / MODEL | MOTOR / ENGINE |
|-------------------------------------|--|---|
| 12.360.010 | 35.12 (Turbodaily) New DAILY (Con Electroventilador / with electric fan) | 8140.27S 4 cilindro / cyli 2800 cm3 Turbo inter-cooler |
| 12.360.015 | Camion / Truck DI 20 C - DI 25 C - D I30 C DI 30 CH - DI 35 C - DI 40 C DI 50 C 500 DI 50 CH - DI 60 C DI 70 C Bus A 90.13 A90.14 315.8.13 316.8.13 | 8035.04.359 8045.04 8045.04 8055.05.250 8060.04.045 8060.04.054 8060.04.052 |
| 12.360.020 | Gama Z 1/87 -- 12/91 50.9 60.11 65.9 79.12 | 8040.05 - 8060.25 8040.05 8040.05 8060.25 |
| 12.360.025 | EUROCARGO 65E12 - 65E14 - 75E12 75E14 - 75E15 - 80E15 80E18 - 80E21 - 85E15 80E18 - 80E21 - 100E15 100E18 - 100E21 120E15 - 120E18 130E15 - 130E18 - 130E21 | 8040.25 / 8040.45 4 CIL. 116-136 VC 8060.25 - 8060.45 6 CIL. 143 - 177 CV 207 CV |
| 12.360.030 | EUROCARGO 120E23 130E23 150E23 280E23 | 8060.45 6 CIL. 5891 CM3 227 CV |
| 12.360.035 | 175.24T./RSU/OTTIMIZZ 190.24 TRU/ TURBOTECH 190.26 TRU/ TURBOTECH 190.32 TRU/ TURBOTECH 220.32 TRU/ TURBOTECH 240.26 TRU/ TURBOTECH 240.32 TRU/ TURBOTECH 260.32 TRU/ TURBOTECH | |
| 12.360.040 | 190 PC 26 - 190.26 H 190 PC 30 - 190.30H 260 PC 26 - 260.26 H 330 PC 26 - 330.26 H 330.30 H | 8210.02.269/731 8210.02.269 8210.22.235 |
| 12.360.045 KIT 12.360.085 | 190.36 TURBOTECH 190.36 TURBOSTAR 220.36 TRU 240.36 TRU 240.36 TURBOSTAR 260.36 TRU 260.36 TURBOSTAR 330.36 H / HT / HW | 8210.42 |

IVECO

| REF. AIR-FREN | MODELO / MODEL | MOTOR / ENGINE |
|---------------------------------|---|--|
| 12.360.050 KIT 12.360.070 | 190.36 TURBOTECH 190.36 TURBOSTAR E.S. 220.36 TRU TURBOTECH 240.36 TRU TURBOTECH 240.36 TURBOSTAR E.S. 260.36 TRU TURBOTECH 260.36 TURBOSTAR E.S. | 8210.42 ECONOMY |
| 12.360.055 KIT 12.360.075 | EUROTECH 180E42 - 190E42 - 240E42 260E42 - 400E42 - 440E42 440E47 EUROTRAKKER 190E37H - 380E37 H/W 410E37 H - 720E37 HT 380E42H/W - 410E42H - 720E42HT EUROSTAR 190E42 - 190E47 240E42 - 240E47 440E42 - 440E47 | 8210.42L 8210.42S.5000 8210.42K 8210.42L 8210.42L SPR 8210.42S.5000 |
| 12.360.060 KIT 12.360.090 | EUROCARGO 120E27 150E27 R320E27 | 8360.46 6 CIL. 7685 CM3 266 CV |
| 12.360.065 | 90.14 A - 3 Serie | 8060.04.689 |
| 12.360.080 | BUS EUROCLASS 380.10.29 - 380.12.29 391.12.29 490.18.29 - 590.18.29 370.12.35 380.10.35 Domino 380.12.35 380.12.38 HD TOPCLASS ORLANDI | 8460.41R 8460.41S |
| 12.360.095 | 30.8 DAILY 30.8 ; 35.8 ; 40.8 28 F 8 DAILY 30 F 8 ; 30.8 DAILY 35 F 8 DAILY 35 F 8 ; 35.8 40 F 8 ; 40.8 DAILY | 8140.61200 8140.61 8140.61 8140.61 8140.61 8140.61 8140.61 |
| 12.360.100 | TURBOSTAR 190.48 - 200.48 240.48 - 260. 48 EUROSTAR 190E52 240E52 440E52 | |



| REF. AIR-FREN | REF. MAN |
|---------------|---------------|
| 12.370.010 | 51 06500 6423 |
| | 51 06500 9423 |
| | 51 06500 6416 |
| | 51 06500 6394 |
| | 51 06500 6374 |
| | 51 06500 6302 |



| Kit reparación / Repair kit | |
|-----------------------------|---------------|
| REF. AIR-FREN | REF. MAN |
| 12.R370.010 | 51 06599 6023 |

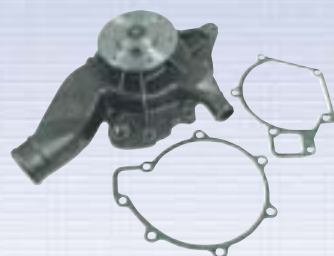

| REF. AIR-FREN | REF. MAN |
|---------------|---------------|
| 12.370.015 | 51 06500 6476 |
| | 51 06500 9476 |

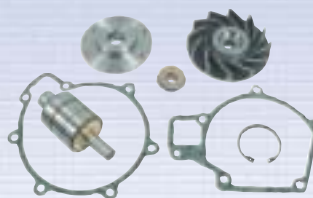

| Kit reparación / Repair kit | |
|-----------------------------|---------------|
| REF. AIR-FREN | REF. MAN |
| 12.R370.015 | 51 06599 6052 |

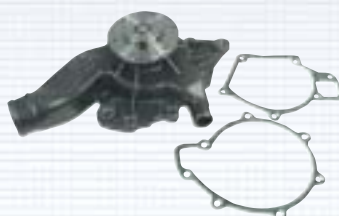

| REF. AIR-FREN | REF. MAN |
|---------------|---------------|
| 12.370.020 | 51 06500 6495 |
| | 51 06500 9495 |

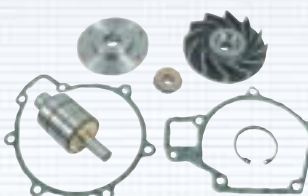

| Kit reparación / Repair kit | |
|-----------------------------|---------------|
| REF. AIR-FREN | REF. MAN |
| 12.R370.015 | 51 06599 6052 |



| REF. AIR-FREN | REF. MAN |
|---------------|---------------|
| 12.370.025 | 51 06500 6228 |

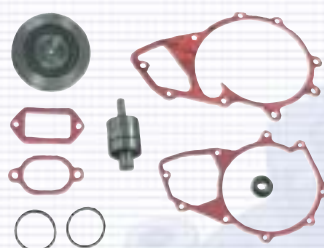

| Kit reparación / Repair kit | |
|-----------------------------|----------|
| REF. AIR-FREN | REF. MAN |
| 12.R380.040 | - |

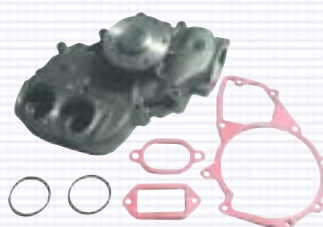

| REF. AIR-FREN | REF. MAN |
|---------------|---------------|
| 12.370.030 | 51 06500 6282 |

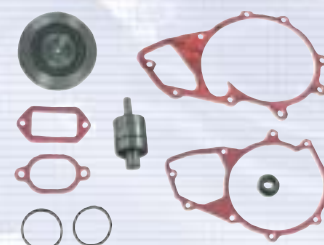

| Kit reparación / Repair kit | |
|-----------------------------|----------|
| REF. AIR-FREN | REF. MAN |
| 12.R380.040 | - |

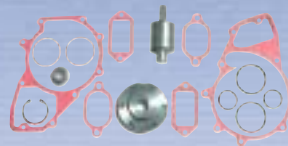

| REF. AIR-FREN | REF. MAN |
|---------------|---------------|
| 12.370.035 | 51 06500 6408 |

Kit reparación / Repair kit

| REF. AIR-FREN | REF. MAN |
|---------------|---------------|
| 12.R380.065 | 51 06599 6033 |

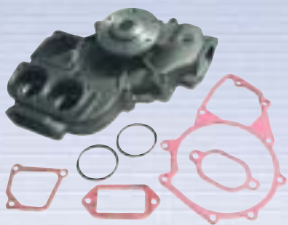

| REF. AIR-FREN | REF. MAN |
|---------------|---------------|
| 12.370.040 | 51 06500 6479 |

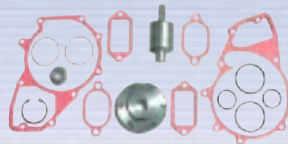
Kit reparación / Repair kit

| REF. AIR-FREN | REF. MAN |
|---------------|---------------|
| 12.R380.065 | 51 06599 6033 |

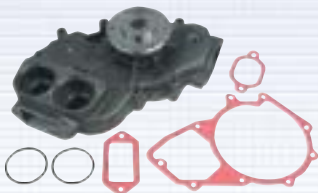

| REF. AIR-FREN | REF. MAN |
|---------------|--------------------------------|
| 12.370.045 | 51 06500 6426 51 06500 9426 |

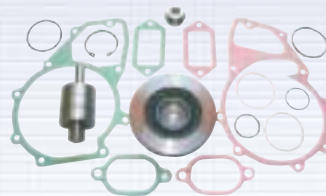
Kit reparación / Repair kit

| REF. AIR-FREN | REF. MAN |
|---------------|---------------|
| 12.R380.065 | 51 06599 6033 |

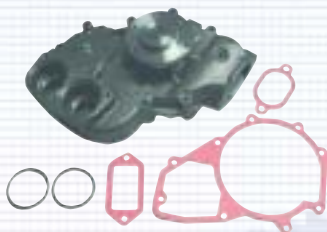

| REF. AIR-FREN | REF. MAN |
|---------------|--------------------------------|
| 12.370.050 | 51 06500 6492 51 06500 9492 |

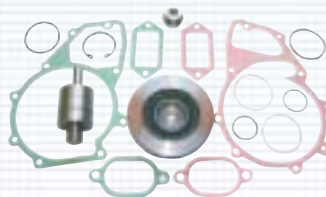
Kit reparación / Repair kit

| REF. AIR-FREN | REF. MAN |
|---------------|---------------|
| 12.R380.065 | 51 06599 6033 |

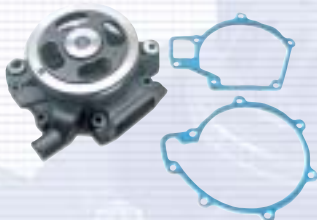

| REF. AIR-FREN | REF. MAN |
|---------------|---------------|
| 12.370.055 | 51 06500 6543 |

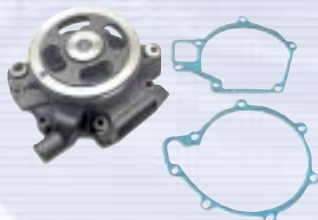

| REF. AIR-FREN | REF. MAN |
|---------------|---------------|
| 12.370.060 | 51 06500 6480 |



| REF. AIR-FREN | REF. MAN |
|---------------|---------------|
| 12.370.065 | 51 06500 6457 |

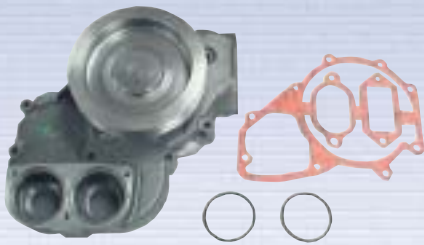

| REF. AIR-FREN | REF. MAN |
|---------------|---------------|
| 12.370.070 | 51 06500 6545 |

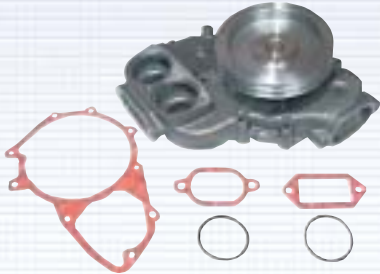

| REF. AIR-FREN | REF. MAN |
|---------------|---------------|
| 12.370.075 | 51 06500 6546 |

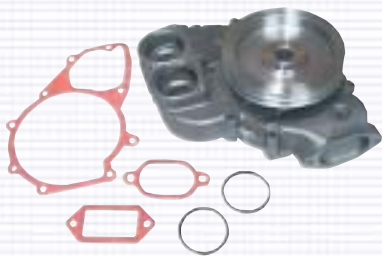

| REF. AIR-FREN | REF. MAN |
|---------------|---------------|
| 12.370.080 | 51 06500 6547 |



| REF. AIR-FREN | REF. MAN |
|---------------|---------------|
| 12.370.085 | 51 06500 6548 |



| REF. AIR-FREN | REF. MAN |
|---------------|---------------|
| 12.370.090 | 51 06500 6537 |



| REF. AIR-FREN | REF. MAN |
|---------------|---------------|
| 12.370.095 | 51 06500 6515 |

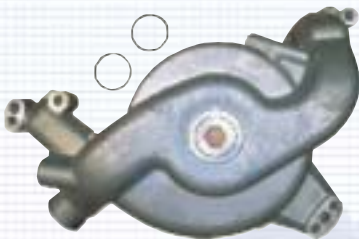

| REF. AIR-FREN | REF. MAN |
|---------------|---------------|
| 12.370.100 | 51 06500 9066 |

TGA



| REF. AIR-FREN | REF. MAN |
|---------------|--------------------------------|
| 12.370.105 | 51 06500 6606 51 06500 6575 |

Kit reparación / Repair kit

| REF. AIR-FREN |
|---------------|
| 12.R370.105 |



| REF. AIR-FREN | MODELO / MODEL | MOTOR / ENGINE |
|---------------|--|--|
| 12.370.010 | 12.170 F / FL / FS / FK 14.170 F / FL / FS / FK 16.170 F / FL / FK / FAK 17.170 F / FL / FK / FAK 12.192 F / FL / FS / FK 14.192 F / FL / FS / FK 16.192 F / FL / FS / FK 17.192 F / FL / FS / FK / FAK 14.220 F / FL / FS / FK 15.220 F / FL / FS / FK 16.220 F / FL / FS / FK 17.220 F / FL / FS / FK | D 0226 MKF /170 D 0226 MKFA/MKH D 0826 LF |
| 12.370.015 | L 90 series 6.100 - 8.150 9.150 - 10.150 M 90 series 12.192 - 14.232 - 17.232 L 2000 series 6.103 - 6.113 - 8.153 - 8.163 8.224 - 9.153 - 10.153 - 10.224 M 2000 series 12.192 - 12.232 - 14.232 11.224 - 13.224 - 15.224 | D 0824 LF D 0826 LF D 0826 LF 01/05 D 0826 LF 02/06 D 0826 LF 217 D 0824 LFL D 0826 LFL 03 |
| 12.370.020 | M 90 series 18.272 M 2000 series 13.264 - 15.264 - 18.264 | D 0826 LF 04 D 0826 LFL 09 |
| 12.370.025 | 30.230 H 14.240 - 20.240 - 20240 D 15.240 - 16.240 - 19.240 - 26.240 - 32240 15.240 - 16.240 - 19.240 22.240 FNL - 26.240 - 30.240VF 16256 - 19.256 - 26.256 - 30.256 - -32.256 16.280 - 20.280 FVLS - 22.280 FNL 26.280 - 30.280 VF 19.280 - 26.280 - 32.280 19.280 F/FL/FS/FT 19.320 - 19.320 - 20.320 - 26.320 - 30.320 - 32.320 | D 2356 HMX D2566 --> Hasta motor 491059 D 2566 M --> Hasta motor 491059 D 2566 MF --> Hasta el motor 491059 02538M / MF --> Hasta motor 3581000 D 2566 MTF --> Hasta motor 3644048 D2566 MT --> Hasta Motor 3644048 D2566 MTL --> Hasta Motor 3644048 D2530 MF --> Hasta Motor 3358073 |



| REF. AIR-FREN | MODELO / MODEL | MOTOR / ENGINE |
|---------------|---|--|
| 12.370.030 | SG 192 - SL 200 - SUE 240 SR 240 - SR 280 SR 240 - SR 280 SR 280 FRH - SG 280 SU 242 SR 321 | D 2566 MUH Desde motor -- 4091103 D 2566 MTUH Desde motor - 4077099 D 2866 UH D 2566 MKUH |
| 12.370.035 | 24.292 - 32.292 - 33.292 40.292 - 41.292 - 48.292 24.332 - 32.332 - 33.332 40.332 - 41.332 - 48.332 19.343 - 33.343 F2000 19.372 - 25.372 - 26.372 - 33.372 F90 24.362 - 32.362 - 33.362 33.362 - 40.362 - 41.362 - 48.362 33.365 19.403 - 26.403 - 33.403 - 41.403 F2000 19.422 - 25.422 - 26.422 - 33.422 F90 32.462 - 33.462 - 40.462 - 48.462 19.463 - 26.463 - 33.463 - 41.463 F2000 | D 2866 LFZ / 290 D 2866 LFZ D 2865 D 2866 D 2866 KFZ D 2866 KF D 2840 MF D 2866 D 2876 D 2540 D 2866 |
| 12.370.040 | Todas las versiones con bomba de inyeccion electronica y retarder. <i>All version with electronic drive injection pump and retarder.</i> | OM 441 LA OM 442 LA |
| 12.370.045 | F 90 series 19.502 - 26.502 33.502 F2000 19.503 19.603 | D 2840 L D 2840 LF D 2840 LF 20 |
| 12.370.050 | F 90 series F 2000 series Todas las versiones con bomba de inyeccion electronica. <i>All version with electronic drive injection pump.</i> | D 2865 LF 5 CYL. D 2866 LF - LXF 6 CYL. D 2876 LF |
| 12.370.055 | 11.190 NL 202 F Altura / Height: 89 mm (desde base cuerpo bomba a parte superior polea). | D 0826 LUH 213 |
| 12.370.060 | 11.190 NL 202 F Altura / Height: 79 mm (desde base cuerpo bomba a parte superior polea). | D 0826 LUH 213 |
| 12.370.065 | 19.293/F2000 19.293 FA/F2000 19.293 FL/F2000 | D 2865 LF 20 D 2865 LF 20 D 2865 LF 20 |
| 12.370.070 | 19.422 19.463 | D 2865 D 2866 D 2876 |



| REF. AIR-FREN | MODELO / MODEL | MOTOR / ENGINE |
|---------------|--|---|
| 12.370.075 | F 2000 series Todas las versiones con bomba inyeccion electronica. <i>All version with electronic drive injection pump.</i> EDC+ Cambio Mecanico. <i>Mechanical gear box.</i> Con retarder. <i>With retarder.</i> | D 2865 LF 5 CYL. D 2866 LF - LXF 6 CYL. D 2876 LF 6 CYL. |
| 12.370.080 | F 2000 series Todas las versiones con bomba inyeccion electronica. <i>All version with electronic drive injection pump.</i> | D 2865 LF 5 CYL. D 2866 LF - LXF 6 CYL. D 2876 LF 6 CYL. |
| 12.370.085 | SIN CRUCE OMP | |
| 12.370.090 | L 2000 series 8.163 - 9.163 - 10.163 M 2000 series 11.163 | D 0824 LFL - 02 D 0824 LFL - 06 D 0824 LFL - 07 |
| 12.370.095 | L 2000 series 6.103 - 6.113 - 8.153 - 9.153 10.153 M 2000 series 11.153 | D 0824 FL D 0824 LFL D 0824 LFO - 01 |
| 12.370.100 | MAN TGA | |
| 12.370.105 | MAN 32270 | |

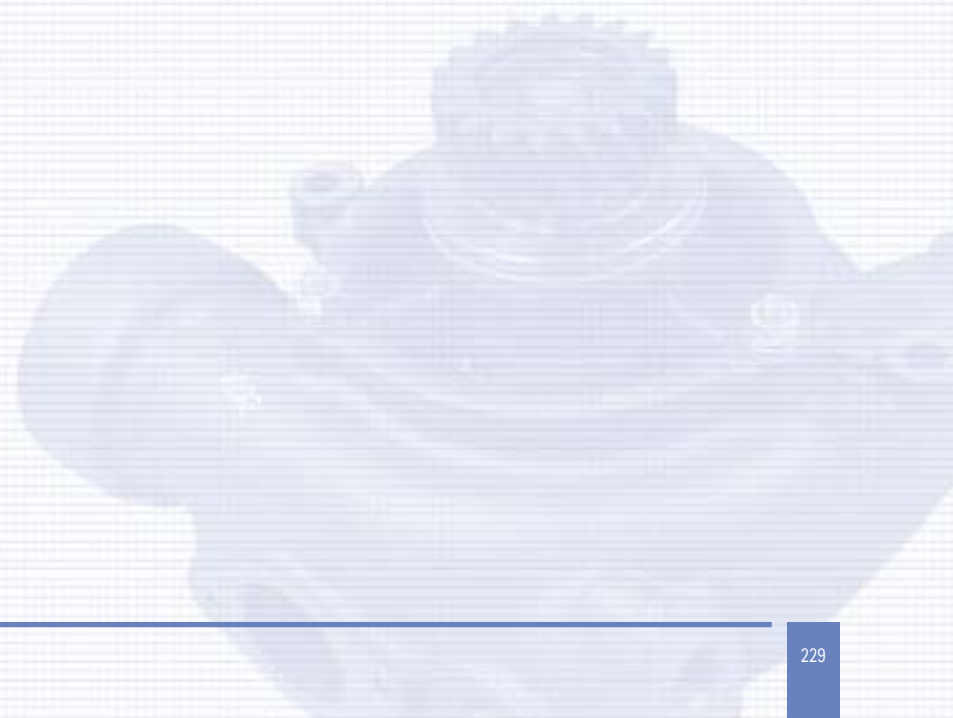



Mercedes-Benz



| REF. AIR-FREN | REF. MERCEDES |
|---------------|---------------|
| 12.380.010 | 314 200 42 01 |
| | 314 200 39 01 |
| | 314 200 37 01 |
| | 314 200 24 01 |



| REF. AIR-FREN | REF. MERCEDES |
|---------------|---------------|
| 12.380.015 | 353 200 37 01 |
| | 353 200 36 01 |
| | 353 200 21 01 |
| | 353 200 04 01 |
| | 353 200 03 01 |
| | 353 200 94 01 |
| | 353 200 84 01 |
| | 353 200 74 01 |
| | 353 200 49 01 |

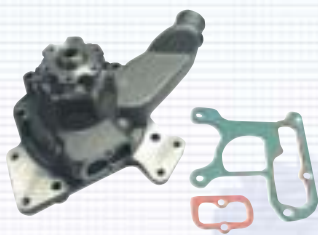

| REF. AIR-FREN | REF. MERCEDES |
|---------------|---------------|
| 12.380.020 | 353 200 56 01 |
| | 353 200 38 01 |
| | 353 200 17 01 |
| | 353 200 16 01 |
| | 353 200 97 01 |
| | 353 200 96 01 |
| | 353 200 95 01 |
| | 353 200 92 01 |
| | 353 200 89 01 |

Kit reparación / Repair kit

| REF. AIR-FREN | REF. MERCEDES |
|---------------|---------------|
| 12.R380.020 | 352 200 45 04 |

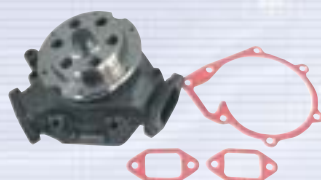

| REF. AIR-FREN | REF. MERCEDES |
|---------------|---------------|
| 12.380.025 | 355 200 08 01 |
| | 355 200 09 01 |
| | 355 200 06 01 |
| | 355 200 01 01 |
| | 355 200 15 01 |
| | 355 200 11 01 |



Mercedes-Benz

Kit reparación / Repair kit

| REF. AIR-FREN | REF. MERCEDES |
|---------------|---------------|
| 12.R380.030 | 364 200 08 04 |



| REF. AIR-FREN | REF. MERCEDES |
|---------------|---|
| 12.380.030 | 364 200 20 01 364 200 09 01 364 200 01 01 |



Kit reparación / Repair kit

| REF. AIR-FREN | REF. MERCEDES |
|---------------|--|
| 12.R380.035 | 366 200 08 04 366 200 06 04 366 200 03 04 366 200 00 04 |

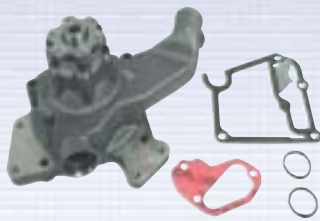

| REF. AIR-FREN | REF. MERCEDES |
|---------------|--------------------------------|
| 12.380.035 | 366 200 59 01 366 200 09 01 |

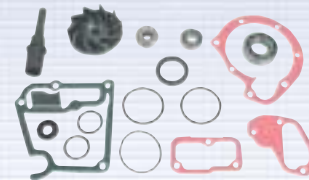

Kit reparación / Repair kit

| REF. AIR-FREN | REF. MERCEDES |
|---------------|---|
| 12.R380.040 | 422 200 03 04 422 200 06 04 422 200 01 04 |



| REF. AIR-FREN | REF. MERCEDES |
|---------------|---------------|
| 12.380.040 | 403 200 70 01 |

Ø 125 mm

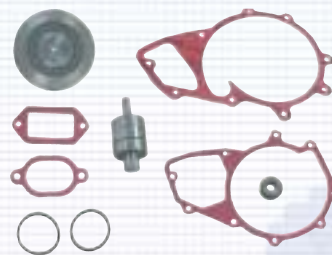

Kit reparación / Repair kit

| REF. AIR-FREN | REF. MERCEDES |
|---------------|---|
| 12.R380.040 | 422 200 03 04 422 200 06 04 422 200 01 04 |

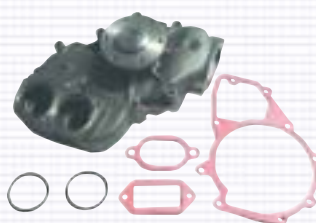

| REF. AIR-FREN | REF. MERCEDES |
|---------------|---|
| 12.380.045 | 403 200 71 01 403 200 51 01 403 200 44 01 |

Ø 125 mm

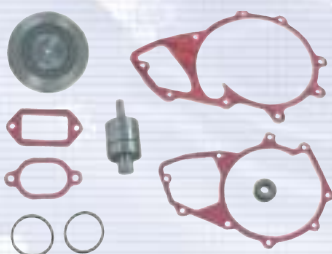



Mercedes-Benz



| REF. AIR-FREN | REF. MERCEDES |
|---------------|---------------|
|---------------|---------------|

| | |
|------------|--|
| 12.380.050 | |
|------------|--|

| | |
|---------------|--|
| 441 200 02 01 | |
| 441 200 01 01 | |

Ø 125 mm

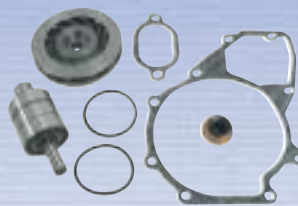
Kit reparación / Repair kit

| REF. AIR-FREN | REF. MERCEDES |
|---------------|---------------|
|---------------|---------------|

| | |
|-------------|--|
| 12.R380.050 | |
|-------------|--|

| | |
|---------------|--|
| 441 200 02 04 | |
|---------------|--|



| REF. AIR-FREN | REF. MERCEDES |
|---------------|---------------|
|---------------|---------------|

| | |
|------------|--|
| 12.380.055 | |
|------------|--|

| | |
|---------------|--|
| 403 200 74 01 | |
|---------------|--|

Ø 125 mm

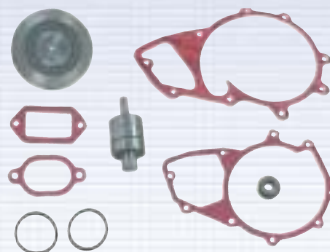
Kit reparación / Repair kit

| REF. AIR-FREN | REF. MERCEDES |
|---------------|---------------|
|---------------|---------------|

| | |
|-------------|--|
| 12.R380.040 | |
|-------------|--|

| | |
|---------------|--|
| 422 200 03 04 | |
|---------------|--|

| | |
|---------------|--|
| 422 200 06 04 | |
|---------------|--|

| | |
|---------------|--|
| 422 200 01 04 | |
|---------------|--|

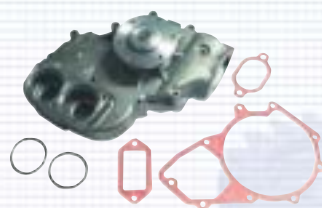

| REF. AIR-FREN | REF. MERCEDES |
|---------------|---------------|
|---------------|---------------|

| | |
|------------|--|
| 12.380.060 | |
|------------|--|

| | |
|---------------|--|
| 422 200 10 01 | |
|---------------|--|

| | |
|---------------|--|
| 422 200 05 01 | |
|---------------|--|

Ø 135 mm

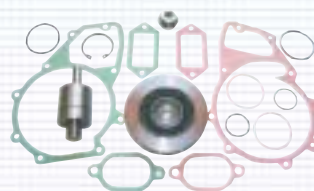

Kit reparación / Repair kit

| REF. AIR-FREN | REF. MERCEDES |
|---------------|---------------|
|---------------|---------------|

| | |
|-------------|--|
| 12.R380.065 | |
|-------------|--|

| | |
|---------------|--|
| 422 200 04 04 | |
|---------------|--|

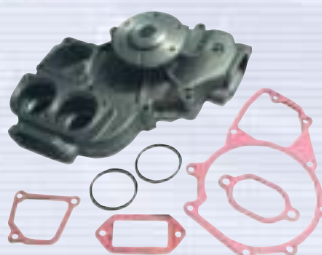
| | |
|---------------|--|
| 422 200 02 04 | |
|---------------|--|



| REF. AIR-FREN | REF. MERCEDES |
|---------------|---------------|
|---------------|---------------|

| | |
|------------|--|
| 12.380.065 | |
|------------|--|

| | |
|---------------|--|
| 422 200 12 01 | |
|---------------|--|

Ø 135 mm

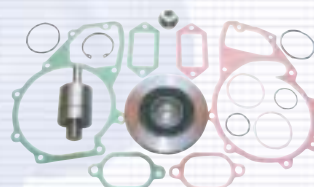
Kit reparación / Repair kit

| REF. AIR-FREN | REF. MERCEDES |
|---------------|---------------|
|---------------|---------------|

| | |
|-------------|--|
| 12.R380.065 | |
|-------------|--|

| | |
|---------------|--|
| 422 200 04 04 | |
|---------------|--|

| | |
|---------------|--|
| 422 200 02 04 | |
|---------------|--|



Mercedes-Benz

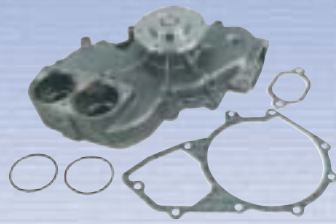

| REF. AIR-FREN | REF. MERCEDES |
|---------------|---------------|
| 12.380.070 | 403 200 76 01 |

Ø 125 mm

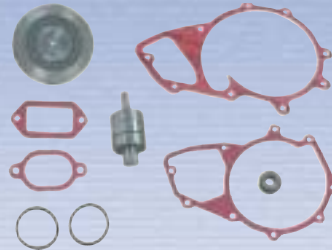

Kit reparación / Repair kit

| REF. AIR-FREN | REF. MERCEDES |
|---------------|---|
| 12.R380.040 | 422 200 03 04 422 200 06 04 422 200 01 04 |



| REF. AIR-FREN | REF. MERCEDES |
|---------------|---------------|
| 12.380.075 | 366 200 68 01 |

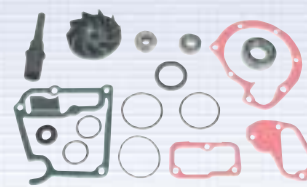

Kit reparación / Repair kit

| REF. AIR-FREN | REF. MERCEDES |
|---------------|--|
| 12.R380.035 | 366 200 08 04 366 200 06 04 366 200 03 04 366 200 00 04 |

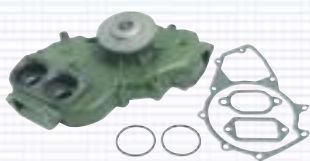

| REF. AIR-FREN | REF. MERCEDES |
|---------------|--------------------------------|
| 12.380.080 | 403 200 73 01 403 200 53 01 |

Ø 125 mm

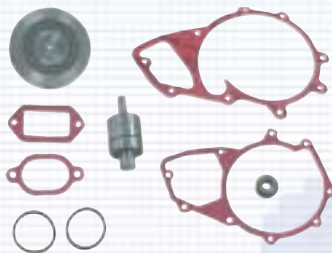

Kit reparación / Repair kit

| REF. AIR-FREN | REF. MERCEDES |
|---------------|---|
| 12.R380.040 | 422 200 03 04 422 200 06 04 422 200 01 04 |



| REF. AIR-FREN | REF. MERCEDES |
|---------------|---------------|
| 12.380.085 | 422 200 11 01 |

Ø 135 mm

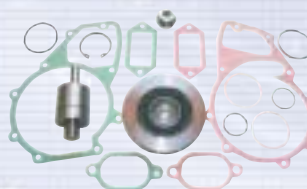

Kit reparación / Repair kit

| REF. AIR-FREN | REF. MERCEDES |
|---------------|--------------------------------|
| 12.R380.065 | 422 200 04 04 422 200 02 04 |



Mercedes-Benz



| REF. AIR-FREN | REF. MERCEDES |
|---------------|---------------|
| 12.380.090 | 542 200 20 01 |

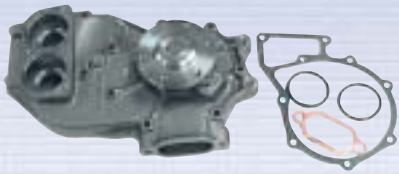

| REF. AIR-FREN | REF. MERCEDES |
|---------------|---------------|
| 12.380.095 | 541 200 12 01 |



| REF. AIR-FREN | REF. MERCEDES |
|---------------|---------------|
| 12.380.100 | 542 200 19 01 |



| REF. AIR-FREN | REF. MERCEDES |
|---------------|---------------|
| 12.380.105 | 904 200 20 01 |

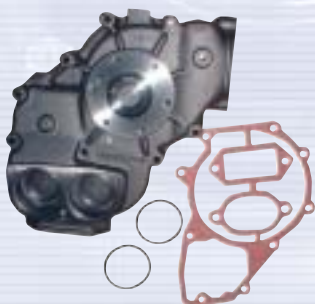

| REF. AIR-FREN | REF. MERCEDES |
|---------------|---------------|
| 12.380.110 | 457 200 05 01 |



Mercedes-Benz



| REF. AIR-FREN | REF. MERCEDES |
|---------------|--------------------------------|
| 12.380.115 | 542 200 22 01 542 200 18 01 |

| Kit reparación / Repair kit | |
|-----------------------------|---------------|
| REF. AIR-FREN | REF. MERCEDES |
| 10.R380.115 | - |



| REF. AIR-FREN | REF. MERCEDES |
|---------------|--------------------------------|
| 12.380.120 | 542 200 21 01 542 200 17 01 |

| Kit reparación / Repair kit | |
|-----------------------------|---------------|
| REF. AIR-FREN | REF. MERCEDES |
| 10.R380.115 | - |



| REF. AIR-FREN | REF. MERCEDES |
|---------------|---------------|
| 12.380.125 | 9042006101 |

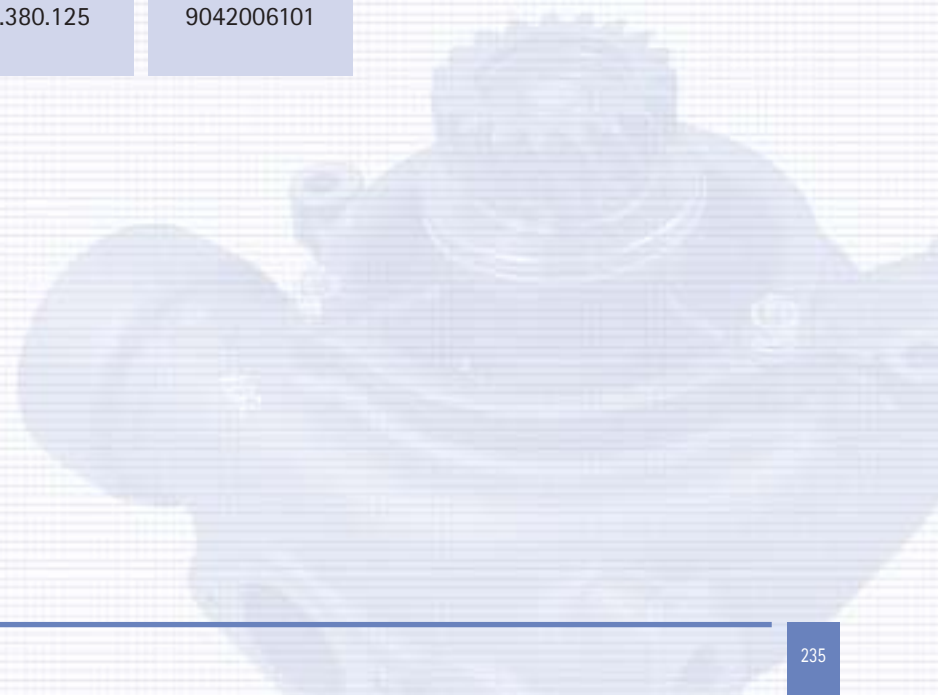



Mercedes-Benz

| REF. AIR-FREN | MODELO / MODEL | MOTOR / ENGINE |
|---------------|---|--|
| 12.380.035 | 814 - 914 - 1114 1314 - 1414 - 1614 817 - 917 - 1117 - 1317 1417 - OH 1417 - 1517 - 1617 1017 - 1120 - 1320 - 1320 S 1324 - 1419 C / CL / L / LS 1520 - 1524 - 1617 - 1619 1620 - 1720 NAW - 2219 2220 - 2222 O 301 O 402 | OM 366 OM 366 A OM 366 LA OM 366 OM 366 A OM 366 OM 366 A |
| 12.380.040 | 1019 - 1219 - 1419 F / L / LS / S 1424 / F - 1619 L - 1619 S 1719 - 1819 - 1919 2219 / L / K - 2419 1624 - 1626 K / L / LP - 1924 L 1926 K / AK - 2026 - 2224 B / K 2226 - 2626 AB / AK 1626 K / L / LP - 1632 K / L / LP 1926 - 1932 - 2032 6X2 - 2226 2232 - 2626 AB / AK 2632 AK / AS - 3032 8X4 2421 O 303 O 303 O 303 O 305 - O 305 G - O 307 | OM 401 -----MOT. 129660 OM 402 -----MOT. 129660 OM 403 -----MOT. 129660 OM 421 OM 401 -----MOT. 129660 OM 402 -----MOT. 129660 OM 403 -----MOT. 129660 OM 407 H 905 / 908 / 909 / 910 / 911 913 / 914 / 915 / 916 / 918 -----MOT. 017497 |

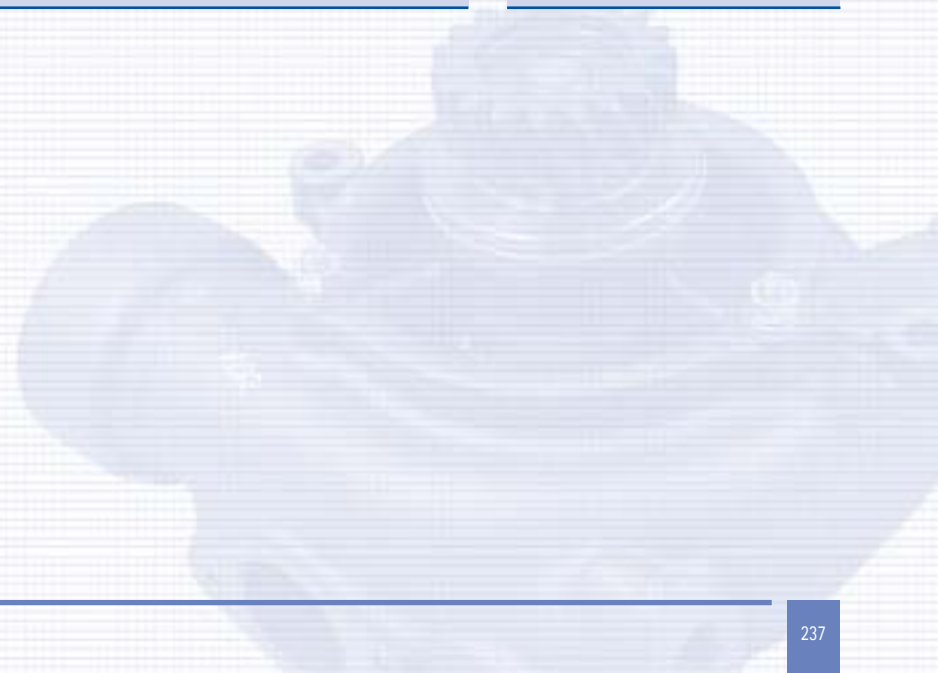



Mercedes-Benz

| REF. AIR-FREN | MODELO / MODEL | MOTOR / ENGINE |
|---------------|--|--|
| 12.380.045 | <p>1019 - 1219 - 1419 F / L / LS / S - 1424 / F 1619 L - 1619 S - 1719 - 1819 - 1919 2219 / L / K - 2419 1624 - 1626 K / L / LP - 1924 L - 1926 K / AK 2026 - 2224 B / K - 2226 - 2626 AB / AK 1626 K / L / LP - 1632 K / L / LP - 1926 - 1932 2032 6X2 - 2226 - 2232 - 2626 AB / AK 2632 AK / AS - 3032 8X4 1222 - 1422 - 1621 S - 1622 OH 1622 - 1922 - 2221 1425 - 1625 - 1628 - 1928 - 2025 - 2028 - 2225 2228 - 2628 - 3025 - 3028 - 3228 - 3328 1633 - 1933 - 2033 - 2233 - 2633 - 3333 8X4 1638 - 1938 - 2238 - 2638 1636 - 1936 - 2036 - 2236 - 2636 - 3333 8X4 1222 - 1422 - 1622 - 1722 - 1922 2222 - 2225 - 2422 - 2426 - 2429 1628 - 1733 - 2228 - 2433</p> <p>1426 - 1625 - 1726 - 1729 - 1928 - 1929 2225 - 2422 - 2426 - 2429 - 2629 - 3529 1635 - 1635 L - 1735 - 1935 - 2035 S / LS 2235 - 2435 - 2635 - 3235 - 3535 1644 - 1748 - 1944 - 1944 S 1948 - 2244 - 2448 - 2644 - 2648</p> <p>O 303 O 303 O 303 O 303 O 303 O 303 O 305 - O 305 G - O 307</p> <p>O 303</p> <p>O 405 ST</p> | <p>OM 401 MOT. 129661-----</p> <p>OM 402 MOT. 129661-----</p> <p>OM 403 MOT. 129661-----</p> <p>OM 421</p> <p>OM 422</p> <p>OM 422 A OM 422 LA OM 423 OM 441 -----MOT. 504397 OM 441 LA-----MOT. 504397 OM 442 -----MOT. 504397 OM 442 A -----MOT. 504397 OM 442 LA -----MOT. 504397 OM 401 MOT. 129661--- OM 402 MOT. 129661--- OM 403 MOT. 129661--- OM 421 - 421 A OM 422 - 422 A OM 407H 905 / 908 / 909 910 / 911 / 913 / 914 / 915 916 / 918 MOT. 017498 OM 441 - 441 A -----MOT. 504397 OM 442 - 442 A OM 427 H 910</p> |
| 12.380.050 | <p>1222- 1422 - 1622 - 1722 - 1922 - 2222 2225 - 2422 - 2426 - 2429 1628 - 1733 - 2228 - 2433</p> <p>1426 - 1625 - 1726 - 1729 - 1928 - 1929 2225 - 2422 - 2426 - 2429 - 2629 - 3529 1635 - 1635 L 1735 - 1935 - 2035 S / LS 2235 - 2435 - 2635 - 3235 - 3535 1644 - 1748 - 1944 - 1944 S 1948 - 2244 - 2448 - 2644 - 2648 1827 - 1831 - 1834 - 2531 - 2534 ECOLINER 1838 - 2038 - 2538 - 1844 - 2044 O 303</p> | <p>OM 441 MOT. 504398----- OM 441 LA MOT. 504398----- OM 442 MOT. 504398----- OM 442 A MOT. 504398----- OM 442 LA MOT. 504398----- OM 441 LA</p> <p>OM 442 LA OM 441 - 441 A MOT. 504398----- OM 442 - 442A</p> |



Mercedes-Benz

| REF. AIR-FREN | MODELO / MODEL | MOTOR / ENGINE |
|---------------|--|---|
| 12.380.055 | 3236 | OM 423.906 |
| 12.380.060 | 3250 3850 4050 ECOLINER 1850 - 2050 | OM 423 LA |
| 12.380.065 | Todas las versiones con bomba de inyeccion electronica y retarder. <i>All version with electronic drive injection pump and retarder.</i> | OM 441 LA OM 442 LA |
| 12.380.070 | Todas las versiones con motor. <i>All version with engine.</i> | OM 441 LA OM 442 LA |
| 12.380.075 | Todas las versiones con motor. <i>All version with engine.</i> | OM 366 /LA BRAZIL |
| 12.380.080 | O 303 O 303 O 305 G O 405 O 405 - O 405 G O 405 ST O 407 GTD - O 407 U Autobús con cambio automático y retarder. <i>Bus with mechanical gear box and retarder.</i> | OM 401.901 /917 MOT. 129661----- OM 402.907 /918 OM 421.908 OM 422.908 /951 OM 407 AH.951 MOT. 017498----- OM 427 HA /950 OM 447 H - HA OM 427 H - OM 447 H OM 447 H - HA |
| 12.380.085 | Todos los modelos / <i>All the models</i> Autobús con cambio automático y retarder. <i>Bus with mechanical gear box and retarder.</i> | OM 422 -----MOT. 146024 |
| 12.380.090 | ACTROS Todas las versiones con retarder. <i>All version with retarder.</i> | OM 501 LA OM 502 LA |
| 12.380.095 | ACTROS 1831 - 1835 -1840 - 1843 1848 - 1853 - 1857 | OM 501 LA OM 502 LA Desde motor 019798--- |
| 12.380.100 | ACTROS 1831 - 1835 - 1840 - 1843 1848 - 1853 - 1857 | OM 501 LA OM 502 LA Hasta motor 019797 |



Air-fren SI

BOMBAS DE AGUA /

WATER PUMPS



Mercedes-Benz

| REF. AIR-FREN | MODELO / MODEL | MOTOR / ENGINE |
|---------------|----------------|--|
| 12.380.105 | Atego, Axor | OM 904 OM 906 OM 909 OM 910 OM 911 OM 919 OM 920 OM 921 OM 922 OM 923 |
| 12.380.110 | | OM 457 |
| 12.380.115 | Actros | OM 542 |
| 12.380.120 | Actros | OM 542 |
| 12.380.125 | | OM 904 |



PEGASO



| REF. AIR-FREN | REF. PEGASO |
|---------------|-------------|
| 12.390.036 | 773.242 |



Kit reparación / Repair kit

| FIG. | REF. AIR-FREN | REF. PEGASO |
|------|---------------|-------------|
| 1 | 12.391.091 | 773.243 |
| 2 | 12.391.088 | 771.921 |
| 3 | 12.391.089 | 772.598 |

Vehículos: Troner 1236/38, Tecno 1234, Tecno 340
 Pegaso 2331, 2431, 2434, 2434-36 K
 Bus Pegaso 5237



| REF. AIR-FREN | REF. PEGASO |
|---------------|-------------|
| 12.390.037 | 774.082 |



Kit reparación / Repair kit

| FIG. | REF. AIR-FREN | REF. PEGASO |
|------|---------------|-------------|
| 1 | 12.391.091 | 773.243 |
| 2 | 12.391.088 | 771.921 |
| 3 | 12.391.089 | 772.598 |

Vehículos: Troner 1236/38, Tecno 1234, Tecno 340
 Pegaso 2331, 2431, 2434, 2434-36 K
 Bus Pegaso 5237



| REF. AIR-FREN | REF. PEGASO |
|---------------|-------------|
| 12.390.038 | 774.083 |



Kit reparación / Repair kit

| FIG. | REF. AIR-FREN | REF. PEGASO |
|------|---------------|-------------|
| 1 | 12.391.091 | 773.243 |
| 2 | 12.391.088 | 771.921 |
| 3 | 12.391.089 | 772.598 |



| REF. AIR-FREN | REF. PEGASO |
|---------------|-------------|
| 12.390.039 | 776.853 |



Kit reparación / Repair kit

| FIG. | REF. AIR-FREN | REF. PEGASO |
|------|---------------|-------------|
| 1 | 12.391.091 | 773.243 |
| 2 | 12.391.088 | 771.921 |
| 3 | 12.391.089 | 772.598 |



| REF. AIR-FREN | REF. PEGASO |
|---------------|-------------|
| 12.390.003 | 197.164 |



| Kit reparación / Repair kit | | |
|-----------------------------|---------------|-------------|
| FIG. | REF. AIR-FREN | REF. PEGASO |
| 1 | 12.391.076 | 648.453 |
| 2 | 12.391.104 | 648.349 |
| 3 | 12.391.089 | 772.598 |

Vehículos: Motores 9220, 9100.56 y 9100.57



| REF. AIR-FREN | REF. PEGASO |
|---------------|-------------|
| 12.390.028 | 648.344 |

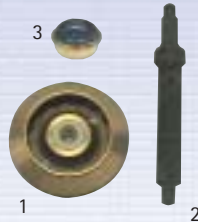

| Kit reparación / Repair kit | | |
|-----------------------------|---------------|-------------|
| FIG. | REF. AIR-FREN | REF. PEGASO |
| 1 | 12.391.076 | 648.453 |
| 2 | 12.391.104 | 648.349 |
| 3 | 12.391.089 | 772.598 |



| REF. AIR-FREN | REF. PEGASO |
|---------------|-------------|
| 12.390.031 | 770.131 |

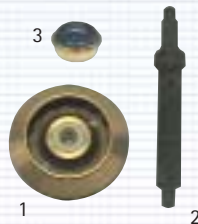

| Kit reparación / Repair kit | | |
|-----------------------------|---------------|-------------|
| FIG. | REF. AIR-FREN | REF. PEGASO |
| 1 | 12.391.076 | 648.453 |
| 2 | 12.391.104 | 648.349 |
| 3 | 12.391.089 | 772.598 |

Vehículos: Pegaso 1223-20
Motores 9220, 9100-56, 9222, 9222-01



| REF. AIR-FREN | REF. PEGASO |
|---------------|-------------|
| 12.390.032 | 770.182 |



| Kit reparación / Repair kit | | |
|-----------------------------|---------------|-------------|
| FIG. | REF. AIR-FREN | REF. PEGASO |
| 1 | 12.391.076 | 648.453 |
| 2 | 12.391.104 | 648.349 |
| 3 | 12.391.089 | 772.598 |

Vehículos: Motores 9109/43, 9220-02, 9220-10, 9220-40

PEGASO



| REF. AIR-FREN | REF. PEGASO |
|---------------|-------------|
| 12.390.024 | 647.355 |

Vehículos: Pegaso 306, 310, 352
Motores 9156, 9157



| Kit reparación / Repair kit | | |
|-----------------------------|---------------|-------------|
| FIG. | REF. AIR-FREN | REF. PEGASO |
| 1 | 12.391.076 | 648.453 |
| 2 | 12.391.067 | 647.363 |
| 3 | 12.391.089 | 772.598 |



| REF. AIR-FREN | REF. PEGASO |
|---------------|-------------|
| 12.390.025 | 647.362 |

Vehículos: Motores 9154-01, 9056-09, 9156-12, 9156-15



| Kit reparación / Repair kit | | |
|-----------------------------|---------------|-------------|
| FIG. | REF. AIR-FREN | REF. PEGASO |
| 1 | 12.391.076 | 648.453 |
| 2 | 12.391.067 | 647.363 |
| 3 | 12.391.089 | 772.598 |



| REF. AIR-FREN | REF. PEGASO |
|---------------|-------------|
| 12.390.034 | 771.098 |

Vehículos: Motor 9152-5



| Kit reparación / Repair kit | | |
|-----------------------------|---------------|-------------|
| FIG. | REF. AIR-FREN | REF. PEGASO |
| 1 | 12.391.076 | 648.453 |
| 2 | 12.391.067 | 647.363 |
| 3 | 12.391.089 | 772.598 |

RENAULT

| REF. AIR-FREN | REF. RENAULT |
|---------------|--------------|
|---------------|--------------|

| | |
|------------|---------------|
| 12.400.015 | 50.00.663.009 |
|------------|---------------|



| REF. AIR-FREN | REF. RENAULT |
|---------------|--------------|
|---------------|--------------|

| | |
|------------|---------------|
| 12.400.020 | 50.10.323.187 |
|------------|---------------|



| REF. AIR-FREN | REF. RENAULT |
|---------------|--------------|
|---------------|--------------|

| | |
|------------|---------------|
| 12.400.035 | 50.00.670.157 |
|------------|---------------|



RENAULT

| REF. AIR-FREN | MODELO / MODEL | MOTOR / ENGINE |
|---------------|--|---|
| 12.400.010 | <p>SM 6 - SM 7 - SM 8 (4x4)</p> <p>SM 7 - SM 8 - SM 8 (4x4) JE 9 - JE 11 - JE 13 - JE 13 (4x4) SM 13 - SM 13 A JP 11 - 130 B11- JP 13 A - 113 B13 JP 14 BOM - 130 B 14 JP 13B - 150 B11- J 13C - 150 B13 JR 19A - JR 19B - 150 B 13 R JR 21 A / B / C - 150 TB 19 / 20 / 21 JX 21 A / B / C - 130 TB 19 / 20 / 21 JN 60 - 130 B 6 - JN 60 A - 130 B 6 A JN 80 - JN 90 - 130 B9 - JN95 - 130 B9A 95.130 - 110.130 (6x6) - 110.150 (4x4) S130.06 - S130.08 - S130.09 - S130.11 - S130.13 - S130.14 S150.06 - S150.08 - S150.09 - S150.11 - S150.13 - S150.14 S 110 - S 150 - S150TI GB 131 - HR 15 G170.15 - G170.16D - G170SP - S170 - S170T - S170SP TRM 4000</p> <p>E 7 C SC 29</p> <p>SC 50</p> | <p>597.10.131.02 - 597.14.132.12 797 - 798.10 797.20 - 797.26 597.10 - 797.11 797.26 797.28 798.10 798.10 797.26</p> <p>797.26 - 798.10</p> <p>797.20</p> <p>798.20</p> <p>797.21 797.26 MIDR 06.02.12</p> <p>797.18</p> <p>798.40</p> <p>797.50</p> |
| 12.400.015 | <p>GLC 190 - GLR 190 PGC 191 - GR 191 - HB19 GC 191 - GF 191 - HB17 GB 191 - HB15 - TB 191 - HB26T</p> <p>GLR 230 PGC 231 - GR 231 - HB19 GC 231 - GF 231 - HF17 GB 231 - HF15 - TB 231 - HF26T TF 231 D</p> <p>GLR 230 (4x4) GRH 235 - HF26V GRH 235 R - HF26V R 770 KB6 FPT - 770 KB6 EAP30 15.05.81 PR 10 S PR 12 S 15.05.81 --> 31.05.85 PR 14 S / 640 PR 14 S / 641 PG 60 - G 45 - G 105</p> <p>PG 60 S - G 45 S - G 105 S PR 100 MI 15.05.81 --> 30.06.83 PR 180 15.05.81 --> 30.06.83</p> | <p>MID 06.20.30</p> <p>MIDS 06.20.30 TURBO</p> <p>MIDS 06.20.30</p> <p>MID 06.20.30</p> <p>MIDS 06.20.30</p> <p>MIDS 06.20.30</p> <p>MIDS 06.20.30</p> <p>MIP 06.20.30 MIPS 06.20.30</p> |



RENAULT

| REF. AIR-FREN | MODELO / MODEL | MOTOR / ENGINE |
|---------------|--|---|
| 12.400.035 | <p>C 210 - CLR 220 C 230 - C 260 - C 280 - C 290</p> <p>C 300 - CCH 300 - C 340 TI G 210 - G 220 - G 230 - G 270 G 260 - G 290 - R 312 - G 320 R 310 - R 330 - R 340 - R 365 1984 --> "G" MANAGER (4x2 / 6x2 / 6x4) G 340 MAXTER (6x4 / 8x4) 1992 --> G 340 TI (4x4 / 6x6) - G 340 TI TR18 T "R" 1990 --> PR 14 SR --> 01.12.84 PR 14 SL PR 100.2 PR 180.2 FR 1 --> 10 / 96 PR 112 - PR 118 CITYBUS AGORA</p> | <p>MIDR 06.20.45</p> <p>MIDR 06.20.45 E/3</p> <p>MIDR 06.20.30</p> <p>MIPS 06.20.45 MIPS 06.20.45 E</p> |
| 12.400.040 | <p>C 230 - C 280</p> <p>C 300 - CCH 300 - C 340 TI G 220 - G 270 G 300 GT MANAGER G 340 MANAGER G 340 MAXTER (6x4 / 8x4) 1992 --> G 340 TI (4x4 / 6x6) G 340 TI TR 18 T FR 1 --> 10 / 96 PR 112 - PR 118 CITYBUS AGORA</p> | <p>MIDR 06.20.45</p> <p>MIDR 06.20.45 E/3</p> <p>MIPS 06.20.45 E</p> |

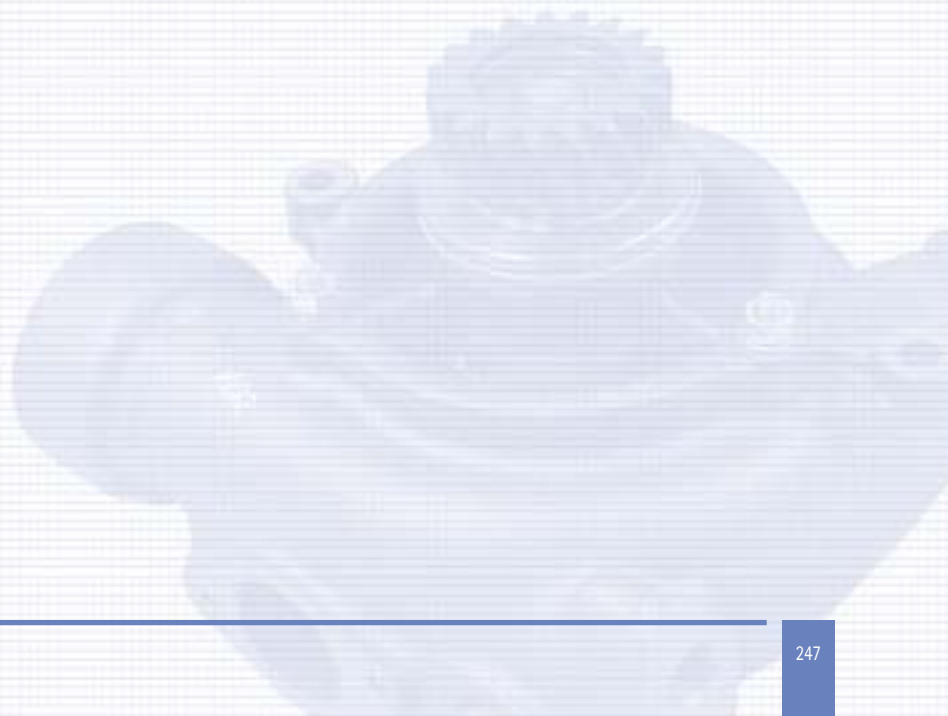



| REF. AIR-FREN | REF. SCANIA |
|---------------|-------------|
| 12.410.010 | 1338490 |
| | 1377571 |
| | 1571067 |
| | 571067 |
| | 397957 |
| | 369902 |
| | 347963 |

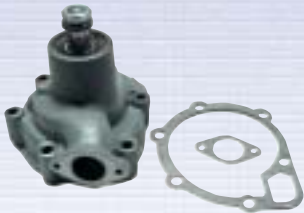

| REF. AIR-FREN | REF. SCANIA |
|---------------|-------------|
| 12.410.015 | 259065 |
| | 571055 |



Kit reparación / Repair kit

| REF. AIR-FREN | REF. SCANIA |
|---------------|-------------|
| 12.R410.015.1 | 550142 |



| | |
|---------------|--------|
| 12.R410.015.2 | 550044 |
|---------------|--------|

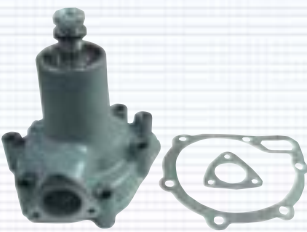

| REF. AIR-FREN | REF. SCANIA |
|---------------|-------------|
| 12.410.020 | 1314406 |
| | 1575100 |
| | 1571059 |
| | 575100 |
| | 571059 |
| | 292761 |



Kit reparación / Repair kit

| REF. AIR-FREN | REF. SCANIA |
|---------------|-------------|
| 12.R410.020.1 | 550167 |



| | |
|---------------|--------|
| 12.R410.015.2 | 550044 |
|---------------|--------|



| REF. AIR-FREN | REF. SCANIA |
|---------------|-------------|
| 12.410.025 | 1354103 |
| | 1571150 |
| | 571150 |



Kit reparación / Repair kit

| REF. AIR-FREN | REF. SCANIA |
|---------------|-------------|
| 12.R410.020.1 | 550167 |



| | |
|---------------|---|
| 12.R410.025.1 | - |
|---------------|---|



| REF. AIR-FREN | REF. SCANIA |
|---------------|-------------|
| 12.410.030 | 261575 |



| Kit reparación / Repair kit | |
|-----------------------------|-------------|
| REF. AIR-FREN | REF. SCANIA |
| 12.R410.045.1 | 550206 |



| | |
|---------------|--------|
| 12.R410.030.1 | 551476 |
|---------------|--------|



| REF. AIR-FREN | REF. SCANIA |
|---------------|-------------|
| 12.410.035 | 320592 |
| | 1571063 |
| | 1375838 |
| | 571063 |
| | 292762 |

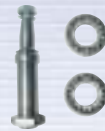

| Kit reparación / Repair kit | |
|-----------------------------|-------------|
| REF. AIR-FREN | REF. SCANIA |
| 12.R410.045.1 | 550206 |



| | |
|---------------|--------|
| 12.R410.030.1 | 551476 |
|---------------|--------|



| REF. AIR-FREN | REF. SCANIA |
|---------------|-------------|
| 12.410.040 | 382183 |
| | 1571153 |
| | 1571068 |
| | 571153 |
| | 571068 |



| Kit reparación / Repair kit | |
|-----------------------------|-------------|
| REF. AIR-FREN | REF. SCANIA |
| 12.R410.045.1 | 550206 |



| | |
|---------------|--------|
| 12.R410.030.1 | 551476 |
|---------------|--------|



| REF. AIR-FREN | REF. SCANIA |
|---------------|-------------|
| 12.410.045 | 1375839 |
| | 1362261 |
| | 1571151 |
| | 571154 |
| | 571151 |



| Kit reparación / Repair kit | |
|-----------------------------|-------------|
| REF. AIR-FREN | REF. SCANIA |
| 12.R410.045.1 | 550206 |



| | |
|---------------|--------|
| 12.R410.045.2 | 551477 |
|---------------|--------|

SCANIA

| REF. AIR-FREN | REF. SCANIA |
|---------------|-------------|
| 12.410.050 | 1380897 |

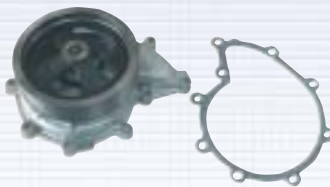

| REF. AIR-FREN | REF. SCANIA |
|---------------|-------------|
| 12.410.055 | 1353072 |



| Kit reparación / Repair kit | |
|-----------------------------|-------------|
| REF. AIR-FREN | REF. SCANIA |
| 12.R410.055 | 551355 |



| REF. AIR-FREN | REF. SCANIA |
|---------------|-------------------|
| 12.410.060 | 1365841 570952 |

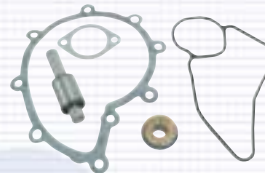

| Kit reparación / Repair kit | |
|-----------------------------|-------------|
| REF. AIR-FREN | REF. SCANIA |
| 12.R410.060 | 551369 |

SCANIA

| REF. AIR-FREN | MODELO / MODEL | MOTOR / ENGINE |
|---------------|--|--|
| 12.410.010 | 92 Series 93 Series | DN 9 DS 9 DSC 9 L DS 9 B DN 9 DS 9 DSC 9 L DS 9 B |
| 12.410.015 | 111 Series Todos los modelos / <i>All the models</i> | D 11 DS 11 |
| 12.410.020 | 112 Series Todos los modelos / <i>All the models</i> 113 Series Todos los modelos / <i>All the models</i> | DS 11 DS 11 DSC 11 |
| 12.410.025 | 113 Series Todos los modelos / <i>All the models</i> Todas las versiones con retarder <i>All version with retarder</i> | DS 11 DSC 11 |
| 12.410.030 | 140 Series Todos los modelos / <i>All the models</i> 141 Series Todos los modelos / <i>All the models</i> 146 Series Todos los modelos / <i>All the models</i> | D 14 - DS 14 D 14 - DS 14 D 14 - DS 14 |
| 12.410.035 | 142 Series Todos los modelos / <i>All the models</i> | DS 14 DSC 14 DS 14 06 DSC 14 01 |
| 12.410.040 | 143 Series Todos los modelos / <i>All the models</i> | DSC 14 03 DSC 14 06 |
| 12.410.045 | 143 Series Todos los modelos / <i>All the models</i> Todas las versiones con retarder <i>All version with retarder</i> | DSC 14 03 DSC 14 06 |
| 12.410.050 | 94 Series Todos los modelos / <i>All the models</i> | DSC 9 11 / 12 / 13 / 15 DS 9 AM DSC 9 AM DSI 9 AM DSC 9 B |
| 12.410.055 | 114 Series Todos los modelos / <i>All the models</i> 124 Series Todos los modelos / <i>All the models</i> | DSC 11 DSC 12 |
| 12.410.060 | 144 Series Todos los modelos / <i>All the models</i> | DSC 14 13 / 15 |



Air-fren

BOMBAS DE AGUA /

WATER PUMPS

VOLVO



| REF. AIR-FREN | REF. VOLVO |
|---------------|------------|
|---------------|------------|

| | |
|------------|-------------------|
| 12.420.010 | 1699785 467906 |
|------------|-------------------|



Kit reparación / Repair kit

| REF. AIR-FREN | REF. VOLVO |
|---------------|------------|
|---------------|------------|

| | |
|-------------|----------------------------|
| 12.R420.010 | 276800 275986 275618 |
|-------------|----------------------------|



| REF. AIR-FREN | REF. VOLVO |
|---------------|------------|
|---------------|------------|

| | |
|------------|---------|
| 12.420.015 | 1545261 |
|------------|---------|

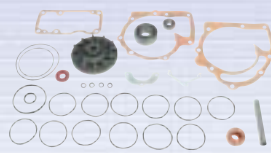

Kit reparación / Repair kit

| REF. AIR-FREN | REF. VOLVO |
|---------------|------------|
|---------------|------------|

| | |
|-------------|------------------|
| 12.R420.015 | 275615 276802 |
|-------------|------------------|



| REF. AIR-FREN | REF. VOLVO |
|---------------|------------|
|---------------|------------|

| | |
|------------|--------------------|
| 12.420.020 | 1545246 1698617 |
|------------|--------------------|

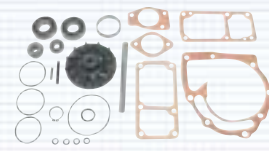

Kit reparación / Repair kit

| REF. AIR-FREN | REF. VOLVO |
|---------------|------------|
|---------------|------------|

| | |
|-------------|----------------------------|
| 12.R420.010 | 276800 275986 275618 |
|-------------|----------------------------|

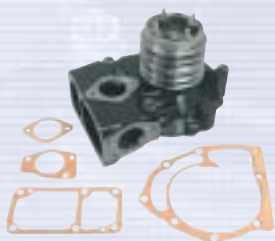

| REF. AIR-FREN | REF. VOLVO |
|---------------|------------|
|---------------|------------|

| | |
|------------|------------------------------|
| 12.420.025 | 467915 1699789 1545427 |
|------------|------------------------------|

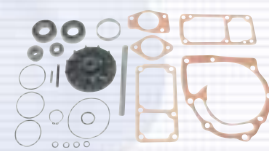

Kit reparación / Repair kit

| REF. AIR-FREN | REF. VOLVO |
|---------------|------------|
|---------------|------------|

| | |
|-------------|----------------------------|
| 12.R420.010 | 276800 275986 275618 |
|-------------|----------------------------|

VOLVO



| REF. AIR-FREN | REF. VOLVO |
|---------------|--------------------|
| 12.420.030 | 1545248 1699788 |



| Kit reparación / Repair kit | |
|-----------------------------|------------|
| REF. AIR-FREN | REF. VOLVO |
| 12.R420.010 | - |



| REF. AIR-FREN | REF. VOLVO |
|---------------|------------|
| 12.420.035 | 422791 |

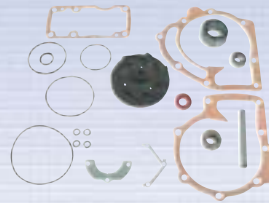

| Kit reparación / Repair kit | |
|-----------------------------|------------|
| REF. AIR-FREN | REF. VOLVO |
| 12.R420.035 | 270791 |



| REF. AIR-FREN | REF. VOLVO |
|---------------|------------|
| 12.420.040 | 1675945 |

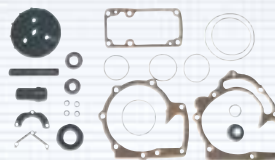

| Kit reparación / Repair kit | |
|-----------------------------|------------|
| REF. AIR-FREN | REF. VOLVO |
| 12.R420.040 | 276814 |



| REF. AIR-FREN | REF. VOLVO |
|---------------|------------|
| 12.420.045 | 425308 |

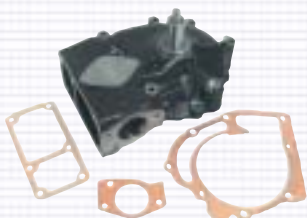

| REF. AIR-FREN | REF. VOLVO |
|---------------|------------|
| 12.420.050 | 422311 |



| Kit reparación / Repair kit | |
|-----------------------------|------------|
| REF. AIR-FREN | REF. VOLVO |
| 12.R420.010 | - |



VOLVO



| REF. AIR-FREN | REF. VOLVO |
|---------------|------------|
| 12.420.055 | 8170305 |



| REF. AIR-FREN | REF. VOLVO |
|---------------|------------------|
| 12.R420.055 | 276854 275613 |



| REF. AIR-FREN | REF. VOLVO |
|---------------|------------|
| 12.420.060 | 8149941 |



| REF. AIR-FREN | REF. VOLVO |
|---------------|------------|
| 12.420.065 | 8149882 |



| REF. AIR-FREN | REF. VOLVO |
|---------------|------------|
| 12.420.070 | 8149980 |



| REF. AIR-FREN | REF. VOLVO |
|---------------|------------|
| 12.420.075 | 8192050 |



| REF. AIR-FREN | REF. VOLVO |
|---------------|----------------------|
| 12.420.080 | 20431135 20713787 |



Kit reparación / Repair kit

| REF. AIR-FREN | REF. VOLVO |
|---------------|------------|
| 12.R420.080 | - |

VOLVO

| REF. AIR-FREN | MODELO / MODEL | MOTOR / ENGINE |
|---------------|--|--|
| 12.420.010 | F 10 --> Hasta chasis 25000 | TD 100 A TD 100 B TD 100 BG TD 100 GA |
| 12.420.015 | F 10 Desde chasis 25001 --> FL 10 INTERCOOLER 320 FL 10 FS 10 F 12 --> Hasta chasis 34000 F 12 Desde chasis 34001 --> F 12 INTERCOOLER 360 Desde chasis 314000 --> F 12 INTERCOOLER 420 N 12 N 12 --> Hasta chasis 12000 NL 10 S NL 12 - NL 12 S B 12 Olympian Mk II | TD 101 F TD 102 F TD 101 F TD 102 F TD 120 C / D / E / F / FC / G / GA TD 121 F / FD / G / GD TD 122 FK / FS TD 120 A / E / G / GA TD 121 F / G / GA TD 121 GA TD 122 FK / FS TD 120 TD 121 TD 122 FK TD 122 FS TD 122 FL TD 122 FH |
| 12.420.020 | F 10 Desde chasis 25001 --> --> Hasta chasis 314000 F 10 INTERCOOLER Desde chasis 314001 --> | TD 101 G TD 101 GA TD 102 TD 103 |
| 12.420.025 | N 10 Desde chasis 304000 --> NL 10 - NL 10 S Desde chasis 304000--> N 10 MARK II Desde chasis 304000 --> | TD 101 USA TD 101 USA TD 101 USA |
| 12.420.030 | N 10 Desde chasis 49001--> NL 10 NL 10 S N 10 MARK II | TD 102 TD 102 TD 102 |
| 12.420.035 | F 10 INTERCOOLER 320 F 12 INTERCOOLER 360 F 12 INTERCOOLER 420 B 12 Olympian Mk II | TD 102 F - OCS TD 122 FK / FS - OCS TD 122 FK / FS - OCS TD 122 FK - OCS TD 122 FS - OCS TD 122 FL - OCS TD 122 FH - OCS |

VOLVO

| REF. AIR-FREN | MODELO / MODEL | MOTOR / ENGINE |
|---------------|---|---|
| 12.420.040 | F 10 Desde chasis 314000 --> FL 10 FS 10 F 12 FL 12 NL 10 NL 10 S NL 12 NL 12 S B 12 --> Hasta chasis 4999 Olympian Mk II | TD 102 TD 103 E TD 103 ES TD 103 TD 123 E TD 123 E TD 123 E TD 123 |
| 12.420.045 | B 9 M B 10 M --> Hasta chasis 20000 B 10 R B 10 B C 10 M B 10 M Desde chasis 20001 --> B 10 R | THD 101 G mot. 50985 --> THD 101 K THD 101 G |
| 12.420.050 | F 88, G 88 | |
| 12.420.055 | FH 12 Desde chasis 2911152 --> FM 12 Para vehículos con cambio manual <i>For vehicles with manual gearbox</i> | D 12 C D 12 C |
| 12.420.060 | FH 12 --> Hasta chasis 2911151 FL 10 FL 12 Para vehículos con cambio manual <i>For vehicles with manual gearbox</i> B 12 --> Hasta chasis 4999 | D 12 A D 12 A D 12 A D 12 A |
| 12.420.065 | FH 12 --> Hasta chasis 2911151 FL 12 Para vehículos con cambio automático. <i>For vehicles with automatic gearbox.</i> Para vehículos con retarder. <i>For vehicles with VOITH hydraulic retarder.</i> B 12 Desde chasis 5000 --> Para vehículos con cambio automático <i>For vehicles with automatic gearbox</i> Para vehículos con retarder <i>For vehicles with VOITH hydraulic retarder</i> | D 12 A 420 D 12 A 420 D 12 A 420 |
| 12.420.070 | FH 16 | D 16 A |

VOLVO

| REF. AIR-FREN | MODELO / MODEL | MOTOR / ENGINE |
|---------------|---|--|
| 12.420.075 | FE 6 FL 6 FL 6 FE 7 FL 7 FS 7 FL 7 FS 7 WHITE B 6 B 6 Excellence 1000 Midi B 6 Midi B 6 - SN9 B 7 Desde chasis 30000 --> | TD 61 TD 63 E D 6 TD 71 D 7 TD 63 E D 6 TD 73 |
| 12.420.080 | FM 12 NH 12 FH 12 | |

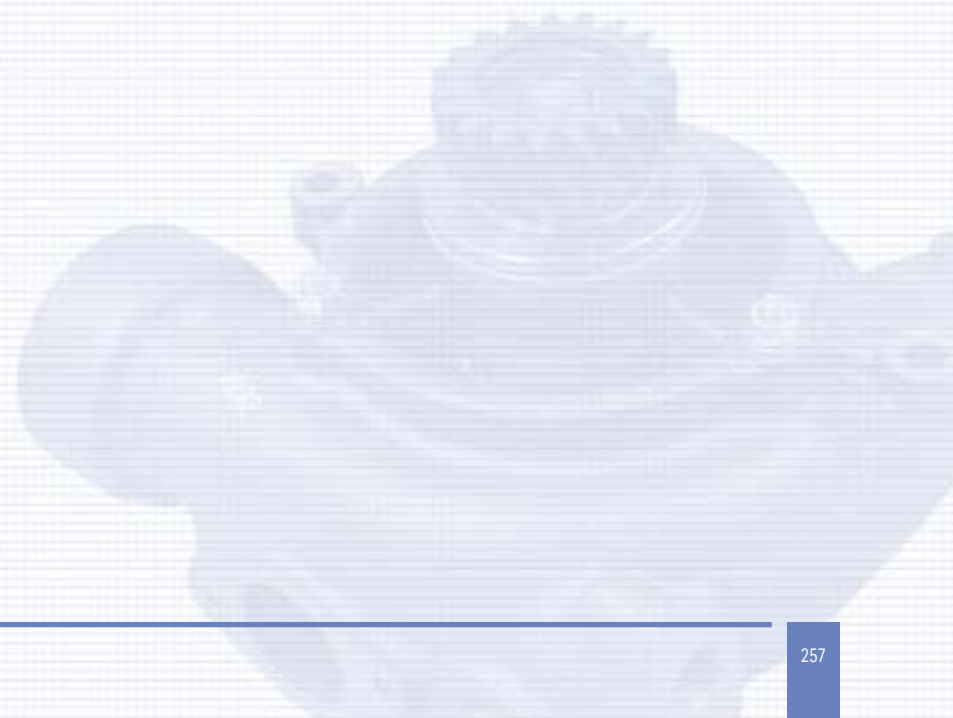

13



**PALANCAS
AUTOMÁTICAS DE FRENO**
AUTOMATIC SLACK ADJUSTERS

PALANCAS AUTOMÁTICAS DE FRENO / AUTOMATIC SLACK ADJUSTERS



(10 Estrías / Splines)



PALANCAS AUTOMÁTICAS DE FRENO /

AUTOMATIC SLACK ADJUSTERS

| FOTO | REF. AIR-FREN | REF. HALDEX | FUNDICIÓN | UNIDAD DE CONTROL | L | POSICIÓN | REF. ORIGINAL |
|------|---------------|-------------|-----------|-------------------|-----|------------|------------------|
| 1 | 13.62197 | 72197/72534 | 4104/2752 | 258/555 | 140 | ↔ D | 282609 537538 |
| 2 | 13.62523 | 72523/72107 | 2760 | 558 | 140 | ← D y T | 159556 278350 |
| 3 | 13.62524 | 72524/72108 | 2761 | 558 | 140 | → D y T | 159557 278351 |
| 4 | 13.62525 | 72525 | 2760 | 555 | 140 | ← D y T | 159558 |
| 5 | 13.62526 | 72526 | 2761 | 555 | 140 | → D y T | 159559 |
| 6 | 13.62532 | 72532 | 2760 | 558 | 165 | ↔ D y T | 92419 |
| 7 | 13.62533 | 72533 | 2761 | 558 | 165 | ↔ D y T | 92420 |
| 8 | 13.62535 | 72535/72202 | 3226 | 558 | 140 | D y T | 159565 284860 |
| 9 | 13.62536 | 72536/72223 | 2987 | 557 | 140 | ↔ T | 159587 289691 |
| 10 | 13.62537 | 72537/72224 | 2985 | 557 | 140 | ↔ T | 159588 289692 |
| 11 | 13.62538 | 72538 | 4042 | 560 | 165 | ↔ T | 159589 |
| 12 | 13.62539 | 72539 | 4043 | 560 | 165 | ← T | 159590 |
| 13 | 13.62540 | 72540 | 3226 | 555 | 165 | ↔ T | 159560 |
| 14 | 13.62542 | 72542 | 2987 | 557 | 165 | ← T | 159561 |
| 15 | 13.62543 | 72543 | 2985 | 557 | 165 | ↔ T | 159562 |
| 16 | 13.62544 | 72544 | 3185 | 556 | 143 | ← T | 159563 |
| 17 | 13.62545 | 72545 | 3186 | 556 | 143 | ↔ T | 159564 |
| 18 | 13.62546 | 72546 | 2752 | 557 | 140 | ↔ T | 159569 |
| 19 | 13.62547 | 72547 | 3226 | 560 | 165 | ↔ D y T | 159576 |
| 20 | 13.62608 | 72608 | 2765 | 555 | 140 | ↔ D y T | 0740321 |
| 21 | 13.62609 | 72609 | 2766 | 555 | 140 | ↔ D y T | 0740322 |
| 22 | 13.62704 | 72704 | 4077 | 555 | 145 | ↔ D y T | 755616 |
| 23 | 13.62705 | 72705 | 4078 | 555 | 145 | ↔ D y T | 755617 |
| 24 | 13.69024 | 79024 | 4070 | 735 | 165 | ← T | 1282111 |
| 25 | 13.69025 | 79025 | 4071 | 735 | 165 | ↔ T | 1282112 |

D= Delantero / Front T= Trasero / Rear



PALANCAS AUTOMÁTICAS DE FRENO / AUTOMATIC SLACK ADJUSTERS



(26 Estrías / Splines)

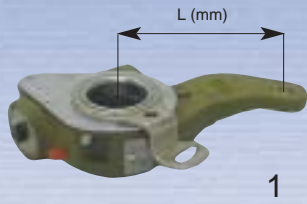

PALANCAS AUTOMÁTICAS DE FRENO /

AUTOMATIC SLACK ADJUSTERS

| FOTO | APLICACIÓN | REF. AIR-FREN | REF. HALDEX | FUNDICIÓN | UNIDAD DE CONTROL | L | POSICIÓN | REF. ORIGINAL |
|------|------------|---------------|----------------------------|-----------|-------------------|-----|------------|----------------------------------|
| 1 | IVECO-MAN | 13.62987 | 72987/72512 79225 | 3522 | 788 | 130 | → D | 81.50610.62.22 |
| 2 | IVECO-MAN | 13.62988 | 72988/72513 79226 | 3523 | 788 | 130 | ← D | 81.50610.62.23 |
| 3 | MAN | 13.60964 | 70964/70730 | 3070 | 861 | 215 | ← T | 81.50610.60.78 |
| 4 | MAN | 13.60965 | 70965 | 3071 | 861 | 215 | → T | 81.50610.61.29 |
| 5 | MAN | 13.62012 | 72012/72965 | 3878 | 688 | 145 | → D y T | 81.50610.61.40 |
| 6 | MAN | 13.62013 | 72013/72966 | 3879 | 688 | 145 | ← D y T | 81.50610.61.39 |
| 7 | MAN | 13.62208 | 72208/79207 | 2752 | 480 | 145 | ↔ T | 81.50610.61.93 |
| 8 | MAN | 13.62303 | 72303/72968 79208 | 3185 | 565 | 145 | ← T | 81.50610.61.65 |
| 9 | MAN | 13.62304 | 72304/72969 79209 | 3186 | 565 | 145 | → T | 81.50610.61.66 |
| 10 | MAN | 13.62320 | 72320/79210 | 3162/4044 | 785/988 | 145 | ← D | 81.50610.61.53 |
| 11 | MAN | 13.62321 | 72321/79211 70723/72971 | 3163/4045 | 785/988 | 145 | → D | 81.50610.61.54 |
| 12 | MAN | 13.62322 | 72322/72972 79212/70734 | 3177/4024 | 566 | 145 | ↔ D | 81.50610.61.51 |
| 13 | MAN | 13.62455 | 72455/79219 72809 | 3163/4045 | 768 | 130 | → D y T | 81.50610.61.82 |
| 14 | MAN | 13.62456 | 72456/79220 72810 | 3162/4044 | 768 | 130 | ← D y T | 81.50610.61.81 |
| 15 | MAN | 13.62508 | 72508/72985 79223 | 3070 | 564 | 215 | → T | 81.50610.61.88 |
| 16 | MAN | 13.62509 | 72509/72986 79224 | 3071 | 564 | 215 | ← T | 81.50610.61.87 |
| 17 | MAN | 13.62578 | 72578/72989 79227 | 2752 | 689 | 145 | ↔ D y T | 81.50610.61.94 81.50610.62.16 |

D= Delantero / Front T= Trasero / Rear



PALANCAS AUTOMÁTICAS DE FRENO / AUTOMATIC SLACK ADJUSTERS



Mercedes-Benz

(26 Estrías / Splines)

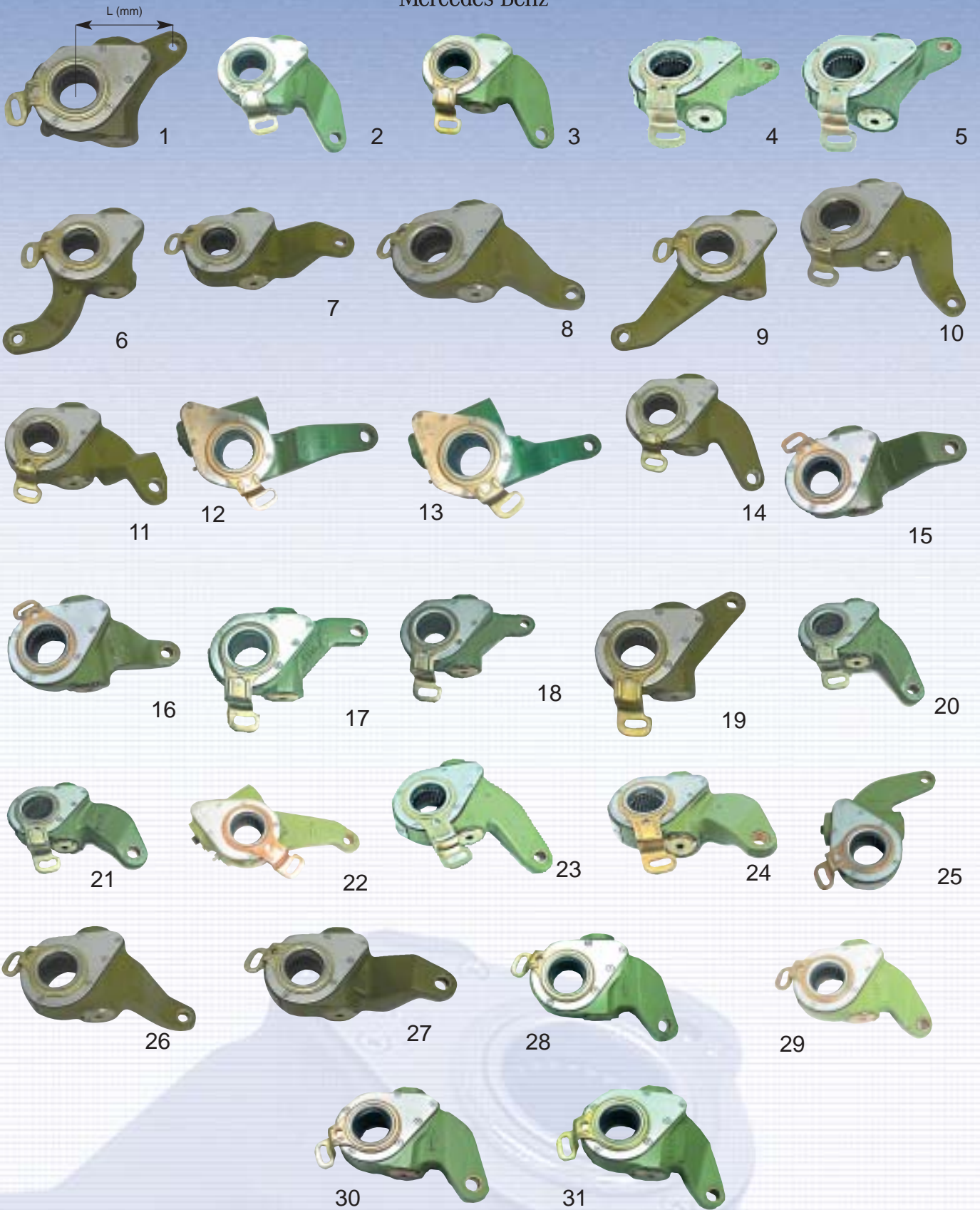

PALANCAS AUTOMÁTICAS DE FRENO /

AUTOMATIC SLACK ADJUSTERS

| FOTO | APLICACIÓN | REF. AIR-FREN | REF. HALDEX | FUNDICIÓN | UNIDAD DE CONTROL | L | POSICIÓN | REF. ORIGINAL |
|------|------------|---------------|-------------|-----------|-------------------|-----|----------|--|
| 1 | MERCEDES | 13.60706 | 70706 | 3078 | 854 | 115 | T ↔ | 305.420.26.38 |
| 2 | MERCEDES | 13.60753 | 70753 | 3162 | 253 | 145 | DyT ↔ | 346.420.15.38/389.420.03.38 620.420.00.38/942.420.06.38 |
| 3 | MERCEDES | 13.60754 | 70754 | 3163 | 253 | 145 | DyT ↔ | 346.420.16.38/389.420.04.38 620.420.01.38/942.420.07.38 |
| 4 | MERCEDES | 13.60771 | 70771 | 3196 | 255 | 115 | T ← | 307.420.02.38 |
| 5 | MERCEDES | 13.60772 | 70772 | 3195 | 255 | 115 | T → | 307.420.01.38 |
| 6 | MERCEDES | 13.60775 | 70775/70966 | 3202 | 864 | 130 | D ↔ | 307.420.03.38 |
| 7 | MERCEDES | 13.60952 | 70952 | 3879 | 782 | 145 | T ← | 617.420.03.38 |
| 8 | MERCEDES | 13.60953 | 70953 | 3878 | 782 | 145 | T → | 617.420.04.38 |
| 9 | MERCEDES | 13.60954 | 70954 | 4024 | 682 | 145 | D ↔ | 617.420.02.38 |
| 10 | MERCEDES | 13.62038 | 72038 | 4004 | 687 | 145 | T ← | 623.420.07.38 |
| 11 | MERCEDES | 13.62039 | 72039 | 4005 | 687 | 145 | T → | 623.420.06.38 |
| 12 | MERCEDES | 13.62040 | 72040/80012 | 4010 | 685 | 145 | D ← | 385.420.17.38 |
| 13 | MERCEDES | 13.62041 | 72041/80013 | 4011 | 685 | 145 | D → | 385.420.18.38 |
| 14 | MERCEDES | 13.62059 | 72059 | 3900 | 686 | 145 | D ↔ | 357.420.05.38 |
| 15 | MERCEDES | 13.62173 | 72173 | 3185 | 293 | 145 | T ← | 387.420.00.38/621.420.01.38 942.420.11.38 |
| 16 | MERCEDES | 13.62174 | 72174 | 3186 | 293 | 145 | T → | 387.420.01.38/621.420.00.38 942.420.10.38 |
| 17 | MERCEDES | 13.62211 | 72211 | 4035 | 477 | 130 | T ← | 357.420.11.38 |
| 18 | MERCEDES | 13.62212 | 72212 | 4036 | 477 | 130 | T → | 357.420.12.38 |
| 19 | MERCEDES | 13.62213 | 72213 | 4037 | 476 | 130 | DyT ↔ | 301.420.11.38 |
| 20 | MERCEDES | 13.62234 | 72234/80008 | 4019 | 785/988 | 145 | D ← | 619.420.02.38/623.420.12.38 623.420.14.38 |
| 21 | MERCEDES | 13.62235 | 72235/80009 | 4018 | 785/988 | 145 | D → | 623.420.13.38/623.420.15.38 619.420.03.38 |
| 22 | MERCEDES | 13.62308 | 72308/70867 | 3177 | 482 | 145 | DyT ↔ | 389.420.07.38/389.420.07.38 620.420.02.38/620.420.03.38 |
| 23 | MERCEDES | 13.62593 | 72593/80008 | 4019 | 881 | 145 | DyT ↔ | 652.420.00.38/658.420.02.38 942.420.09.38 |
| 24 | MERCEDES | 13.62594 | 72594/80009 | 4018 | 881 | 145 | DyT ↔ | 652.420.01.38/658.420.03.38 942.420.08.38 |
| 25 | MERCEDES | 13.62596 | 72596 | 3900 | 885 | 145 | DyT ↔ | 652.420.02.38 |
| 26 | MERCEDES | 13.62616 | 72616/80000 | 3878 | 802 | 145 | T ← | 619.420.06.38 |
| 27 | MERCEDES | 13.62617 | 72617/80001 | 3879 | 802 | 145 | T → | 619.420.07.38 |
| 28 | MERCEDES | 13.62809 | 72809 | 3163 | 768 | 130 | DyT ↔ | 357.420.13.38 |
| 29 | MERCEDES | 13.62810 | 72810 | 3162 | 768 | 130 | DyT ↔ | 357.420.14.38 |
| 30 | MERCEDES | 13.62811 | 72811 | 3163 | 512 | 130 | DyT ↔ | 357.420.15.38 |
| 31 | MERCEDES | 13.62812 | 72812 | 3162 | 512 | 130 | DyT ↔ | 357.420.16.38 |

D= Delantero / Front T= Trasero / Rear



Mercedes-Benz

PALANCAS AUTOMÁTICAS DE FRENO /
AUTOMATIC SLACK ADJUSTERS



RENAULT

(27 Estrías / Splines)

* (28 Estrías / Splines)

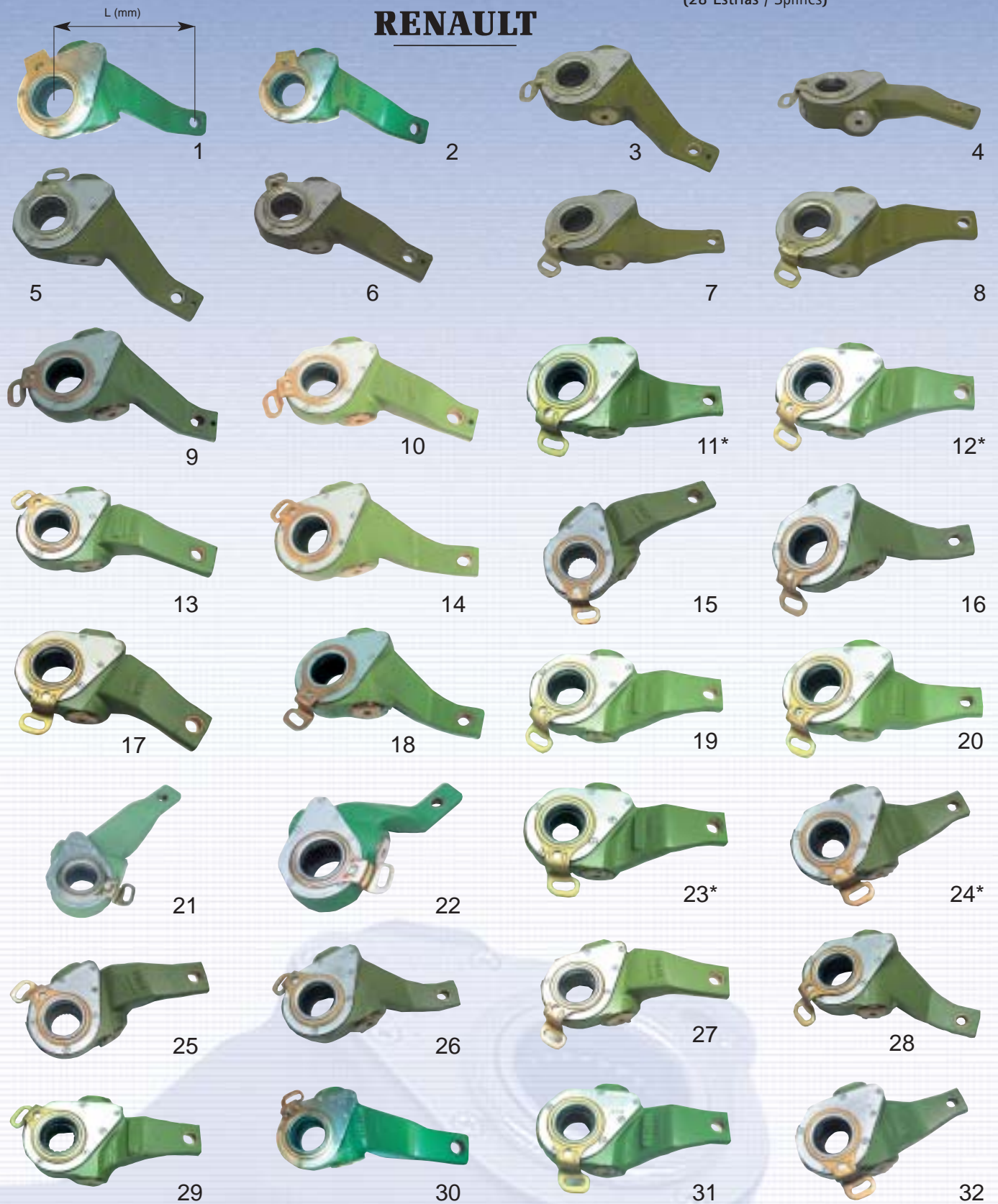

PALANCAS AUTOMÁTICAS DE FRENO /

AUTOMATIC SLACK ADJUSTERS

| FOTO | APLICACIÓN | REF. AIR-FREN | REF. HALDEX | FUNDICIÓN | UNIDAD DE CONTROL | L | POSICIÓN | REF. ORIGINAL |
|------|------------|---------------|-------------|-----------|-------------------|-----|------------|---------------|
| 1 | RENAULT | 13.62005 | 72005/79007 | 4008 | 981 | 175 | → T | 5010098861 |
| 2 | RENAULT | 13.62006 | 72006/79008 | 4009 | 981 | 175 | ← T | 5000787265 |
| 3 | RENAULT | 13.62160 | 72160/79013 | 4008 | 374 | 175 | ← T | 5010056685 |
| 4 | RENAULT | 13.62161 | 72161/79014 | 4009 | 374 | 175 | → T | 5010056686 |
| 5 | RENAULT | 13.62162 | 72162/79015 | 4008 | 992 | 175 | ← D | 5000789894 |
| 6 | RENAULT | 13.62163 | 72163/79016 | 4009 | 992 | 175 | → D | 5000789895 |
| 7 | RENAULT | 13.62318 | 72318/79017 | 2761 | 372 | 175 | ← T | 5000791212 |
| 8 | RENAULT | 13.62319 | 72319/79018 | 2760 | 372 | 175 | → T | 5000791213 |
| 9 | RENAULT | 13.62738 | 72738/79286 | 4008 | 374 | 160 | ↔ D y T | 5010145883 |
| 10 | RENAULT | 13.62739 | 72739/79287 | 4009 | 374 | 160 | ↔ D y T | 5010145884 |
| 11 | RENAULT | 13.62740 | 72740/79288 | 4095/2761 | 489 | 160 | → T | 5010098831 |
| 12 | RENAULT | 13.62741 | 72741/79289 | 4094/2760 | 489 | 160 | ← T | 5010098832 |
| 13 | RENAULT | 13.62786 | 72786/79290 | 3717 | 488 | 175 | ← D | 5010216246 |
| 14 | RENAULT | 13.62787 | 72787/79291 | 3718 | 488 | 175 | → D | 5010216247 |
| 15 | RENAULT | 13.62798 | 72798/79294 | 3717 | 696 | 160 | → T | 5010098860 |
| 16 | RENAULT | 13.62799 | 72799/79295 | 3718 | 696 | 160 | ← T | 5010098861 |
| 17 | RENAULT | 13.62813 | 72813/79296 | 3717 | 733 | 160 | ← T | 5010098862 |
| 18 | RENAULT | 13.62814 | 72814/79297 | 3718 | 733 | 160 | → T | 5010098863 |
| 19 | RENAULT | 13.62835 | 72835/79299 | 2760 | 372 | 160 | ← T | 5010216843 |
| 20 | RENAULT | 13.62836 | 72836/79300 | 2761 | 372 | 160 | → T | 5010216844 |
| 21 | RENAULT | 13.62993 | 72993/79440 | 3717 | 627 | 160 | ← T | 5010197577 |
| 22 | RENAULT | 13.62994 | 72994/79441 | 3718 | 627 | 160 | → T | 5010197578 |
| 23 | RENAULT | 13.62997 | 72997/79304 | 4094/2760 | 573 | 160 | ← T | 5010260027 |
| 24 | RENAULT | 13.62998 | 72998/79305 | 4095/2761 | 573 | 160 | → T | 5010260028 |
| 25 | RENAULT | 13.69077 | 79077/79310 | 3717 | 812 | 160 | → D | 5010260117 |
| 26 | RENAULT | 13.69078 | 79078/79311 | 3718 | 812 | 160 | ← D | 5010260118 |
| 27 | RENAULT | 13.69294 | 79294/72798 | 3717 | 696 | 160 | → T | 5010098860 |
| 28 | RENAULT | 13.69295 | 79295/72799 | 3718 | 696 | 160 | ← T | 5010098861 |
| 29 | RENAULT | 13.69308 | 79308/79075 | 3717 | 812 | 175 | → D | 5010260115 |
| 30 | RENAULT | 13.69309 | 79309/79076 | 3718 | 812 | 175 | ← D | 5010260116 |
| 31 | RENAULT | 13.69683 | 79683 | 2760 | 573 | 160 | → T | 5430260288 |
| 32 | RENAULT | 13.69684 | 79684 | 2761 | 573 | 160 | ← T | 5430260289 |

D= Delantero / Front T= Trasero / Rear

SCANIA

(10 Estrías / Splines)

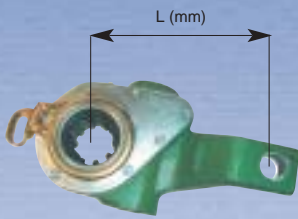

1



2



3



4



5

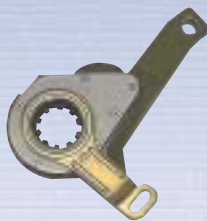

6



7



8



9



10



11



12



13



14



15



16



17



18



19



20



21

PALANCAS AUTOMÁTICAS DE FRENO /

AUTOMATIC SLACK ADJUSTERS

| FOTO | APLICACIÓN | REF. AIR-FREN | REF. HALDEX | FUNDICIÓN | UNIDAD DE CONTROL | L | POSICIÓN | REF. ORIGINAL |
|------|------------|---------------|-------------|-----------|-------------------|-----|------------|---------------|
| 1 | SCANIA | 13.62468 | 72468/72893 | 4050 | 505 | 130 | → T | 394194 |
| 2 | SCANIA | 13.62469 | 72469/72892 | 4051 | 505 | 130 | ← T | 394193 |
| 3 | SCANIA | 13.62478 | 72478/72729 | 3884 | 499 | 130 | → T | 394195 |
| 4 | SCANIA | 13.62620 | 72620/72663 | 3705 | 229 | 165 | ← D | 1112829 |
| 5 | SCANIA | 13.62621 | 72621/72664 | 3704 | 229 | 165 | → D | 1112830 |
| 6 | SCANIA | 13.62622 | 72622/72662 | 3226 | 230 | 165 | ↔ T | 1112831 |
| 7 | SCANIA | 13.62624 | 72624/72660 | 3662 | 230 | 165 | ← T | 1112833 |
| 8 | SCANIA | 13.62625 | 72625/72661 | 3663 | 230 | 165 | → T | 1112834 |
| 9 | SCANIA | 13.62628 | 72628/79347 | 4021 | 233 | 165 | ← T | 1112837 |
| 10 | SCANIA | 13.62629 | 72629/79348 | 4020 | 233 | 165 | → T | 1112838 |
| 11 | SCANIA | 13.62630 | 72630/72488 | 4040 | 235 | 165 | → D | 1112839 |
| 12 | SCANIA | 13.62631 | 72631 | 4041 | 235 | 165 | ← D | 1112840 |
| 13 | SCANIA | 13.62654 | 72654/72632 | 3891 | 230 | 165 | ↔ T | 1112841 |
| 14 | SCANIA | 13.62660 | 72660/72624 | 3662 | 453 | 165 | ← T | 278737 |
| 15 | SCANIA | 13.62661 | 72661/72625 | 3663 | 453 | 165 | → T | 278738 |
| 16 | SCANIA | 13.62690 | 72690/79368 | 4066 | 165 | 165 | ← T | 1108061 |
| 17 | SCANIA | 13.62691 | 72691/79369 | 4067 | 165 | 165 | → T | 1108062 |
| 18 | SCANIA | 13.62729 | 72729/72960 | 3884 | 499 | 130 | ↔ T | 383826 |
| 19 | SCANIA | 13.62730 | 72730/72961 | 3883 | 499 | 130 | ↔ T | 383825 |
| 20 | SCANIA | 13.69033 | 79033/79442 | 4083 | 235 | 165 | ↔ D y T | 1358634 |
| 21 | SCANIA | 13.69034 | 79034/79443 | 4084 | 235 | 165 | ↔ D y T | 1358635 |

D= Delantero / Front T= Trasero / Rear



VOLVO

(10 Estrías / Splines)

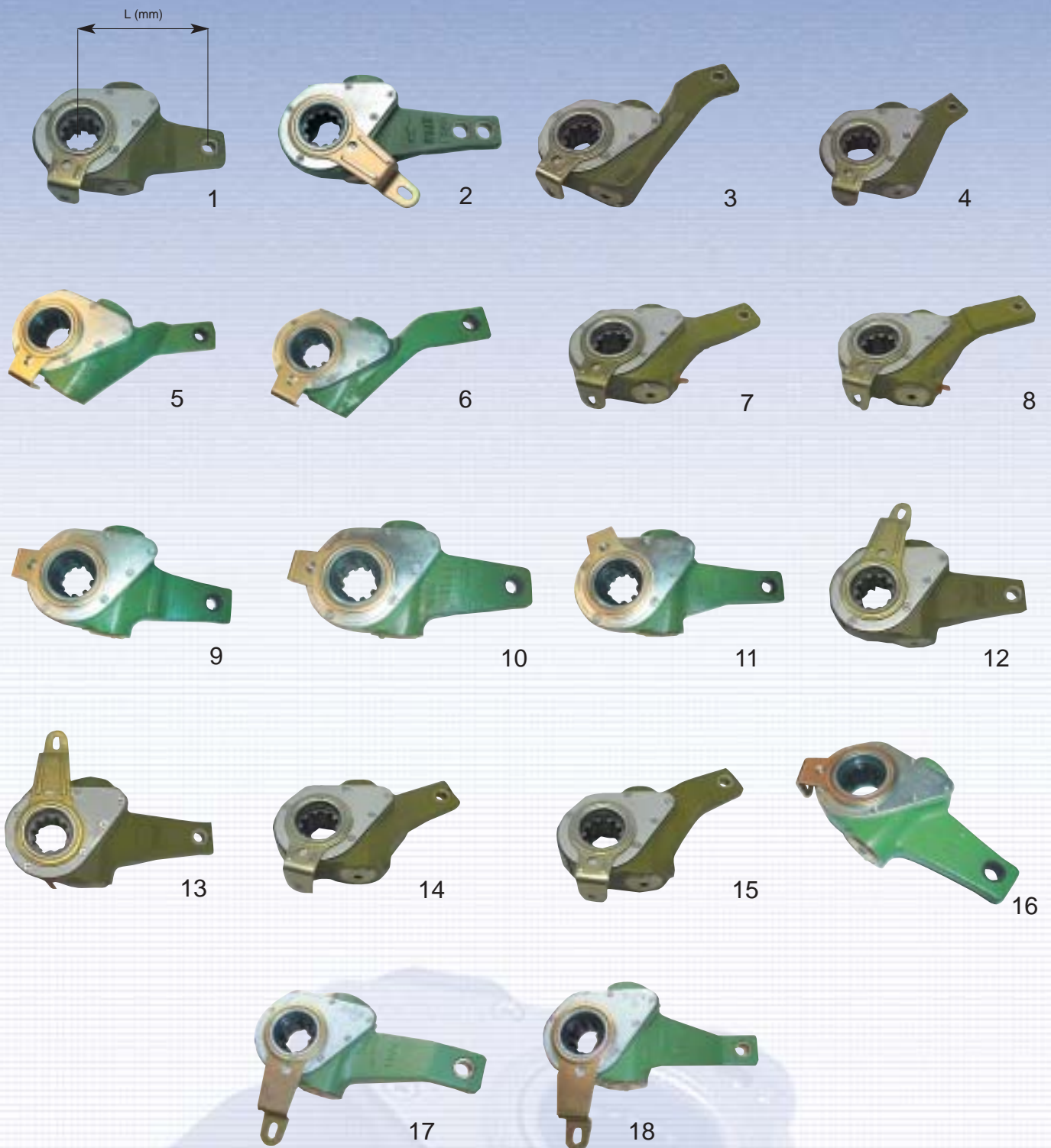

PALANCAS AUTOMÁTICAS DE FRENO /

AUTOMATIC SLACK ADJUSTERS

| FOTO | APLICACIÓN | REF. AIR-FREN | REF. HALDEX | FUNDICIÓN | UNIDAD DE CONTROL | L | POSICIÓN | REF. ORIGINAL |
|------|------------|---------------|----------------------|-----------|-------------------|---------|------------|---------------|
| 1 | VOLVO | 13.60635 | 70635/72713 72714 | 2766 | 447 | 127 | ↔ D y T | 1134297 |
| 2 | VOLVO | 13.60920 | 70920/79178 | 2752 | 453 | 140/165 | ↔ D y T | 1586194 |
| 3 | VOLVO | 13.60921 | 70921/72668 | 2987 | 444 | 151 | ← T | 1586190 |
| 4 | VOLVO | 13.60922 | 70922/72669 | 2985 | 444 | 151 | → T | 1586191 |
| 5 | VOLVO | 13.60923 | 70923/72670 | 2987 | 444 | 165 | ↔ T | 1586192 |
| 6 | VOLVO | 13.60924 | 70924/72671 | 2985 | 444 | 165 | ↔ T | 1586193 |
| 7 | VOLVO | 13.62232 | 72232/72784 | 4039 | 448 | 165 | ← T | 1197965 |
| 8 | VOLVO | 13.62233 | 72233/72785 | 4038 | 448 | 165 | → T | 1197966 |
| 9 | VOLVO | 13.62672 | 72672/72022 | 2766 | 402 | 140 | ← D y T | 1592871 |
| 10 | VOLVO | 13.62673 | 72673/72023 | 2765 | 402 | 140 | → D y T | 1592872 |
| 11 | VOLVO | 13.62676 | 72676/72026 | 4085 | 983 | 152 | ↔ D | 1592876 |
| 12 | VOLVO | 13.62678 | 72678 | 2752 C | 472 | 140 | ↔ D | 1196321 |
| 13 | VOLVO | 13.62726 | 72726 | 2752 B | 472 | 152 | ↔ D | 1196322 |
| 14 | VOLVO | 13.62782 | 72782/72152 | 3861 | 448 | 145 | ← T | 1195461 |
| 15 | VOLVO | 13.62783 | 72783/72153 | 3860 | 448 | 145 | → T | 1195462 |
| 16 | VOLVO | 13.69072 | 79072/79564 | 4104 | 921 | 140 | ↔ T | 9518357 |
| 17 | VOLVO | 13.69677 | 79677 | 3704 | 181 | 165 | ↔ D y T | - |
| 18 | VOLVO | 13.69678 | 79678 | 3705 | 181 | 165 | ↔ D y T | - |

D= Delantero / Front T= Trasero / Rear



VOLVO

IVECO - PEGASO

(19 Estrías / Splines)



1



2

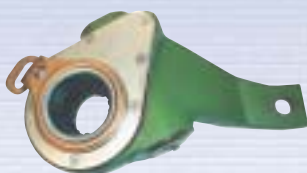

3



4

PALANCAS AUTOMÁTICAS DE FRENO /

AUTOMATIC SLACK ADJUSTERS

| FOTO | APLICACIÓN | REF. AIR-FREN | REF. HALDEX | FUNDICIÓN | UNIDAD DE CONTROL | L | POSICIÓN | REF. ORIGINAL |
|------|--------------|---------------|-------------|-----------|-------------------|-----|----------|---------------|
| 1 | IVECO-PEGASO | 13.62408 | 72408 | 2752 | 376 | 180 | D y T | 914265 |
| 2 | IVECO-PEGASO | 13.62804 | 72804 | 4085 | 709 | 160 | D y T | 917982 |
| 3 | IVECO | 13.69462 | 79462/72929 | 4040 | 628 | 152 | T y D | 42536274 |
| 4 | IVECO | 13.69463 | 79463 | 3068 | 373 | 152 | T y D | 42536275 |

D= Delantero / Front T= Trasero / Rear



TIPO S-ABA

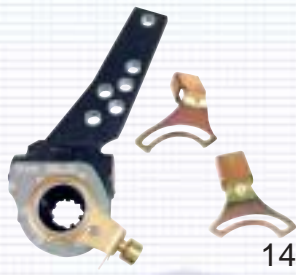

PALANCAS AUTOMÁTICAS DE FRENO /

AUTOMATIC SLACK ADJUSTERS

Palancas tipo S-ABA - TRACTORA

| FOTO | APLICACIÓN | REF. AIR-FREN | REF. HALDEX | FUNDICIÓN | UNIDAD DE CONTROL | L | ESTRÍAS / SPLINES | POSICIÓN | REF. ORIGINAL |
|------|-----------------|---------------|----------------------------|-----------|-------------------|-----|-------------------|----------|---------------|
| 1 | MERCEDES | 13.90000 | 80000C | 5018 | 527 | 145 | 26 | ← | 945 420 02 38 |
| 2 | MERCEDES | 13.90001 | 80001C | 5017 | 527 | 145 | 26 | → | 945 420 03 38 |
| 3 | MERCEDES | 13.90008 | 80008C | 5016 | 528 | 145 | 26 | ← | 945 420 00 38 |
| 4 | MERCEDES | 13.90009 | 80009C | 5015 | 528 | 145 | 26 | → | 945 420 01 38 |
| 5 | MERCEDES MAN | 13.90010 | 80010C 80092C 80180C | 5020 | 527 | 145 | 26 | ← | 945 420 08 38 |
| 6 | MERCEDES MAN | 13.90011 | 80011C 80093C 80181C | 5019 | 527 | 145 | 26 | → | 945 420 07 38 |
| 7 | MERCEDES | 13.90012 | 80012C | 5032 | 527 | 145 | 26 | ← | 945 420 05 38 |
| 8 | MERCEDES | 13.90013 | 80013C | 5033 | 527 | 145 | 26 | → | 945 420 06 38 |
| 9 | MERCEDES | 13.90014 | 80014C | 5031 | 527 | 145 | 26 | → | 945 420 04 38 |
| 10 | MERCEDES | 13.90030 | 80030C | 5018 | 527 | 145 | 26 | ← | 945 420 09 38 |

Palancas tipo S-ABA - PLATAFORMA

| FOTO | APLICACIÓN | REF. AIR-FREN | REF. HALDEX | FUNDICIÓN | UNIDAD DE CONTROL | ESTRÍAS / SPLINES | POSICIÓN |
|------|------------|---------------|-------------|-----------|-------------------|-------------------|----------|
| 11 | BPW | 13.90019 | 80019S | 5027 | 530 | 10 | ↔ |
| 12 | ROR | 13.90020 | 80020S | 5027 | 530 | 10 | ↔ |
| 13 | FRUEHAUF | 13.90021 | 80021S | 5027 | 530 | 37 | ↔ |
| 14 | SAF | 13.90022 | 80022S | 5027 | 530 | 10 | ↔ |
| 15 | SAF | 13.90041 | 80041C | 5027 | 530 | 10 | ↔ |
| 16 | TRAILOR | 13.90023 | 80023S | 5027 | 530 | 10 | ↔ |
| 17 | TRAILOR | 13.90024 | 80024S | 5027 | 530 | 10 | ↔ |

PALANCAS AUTOMÁTICAS DE FRENO / AUTOMATIC SLACK ADJUSTERS

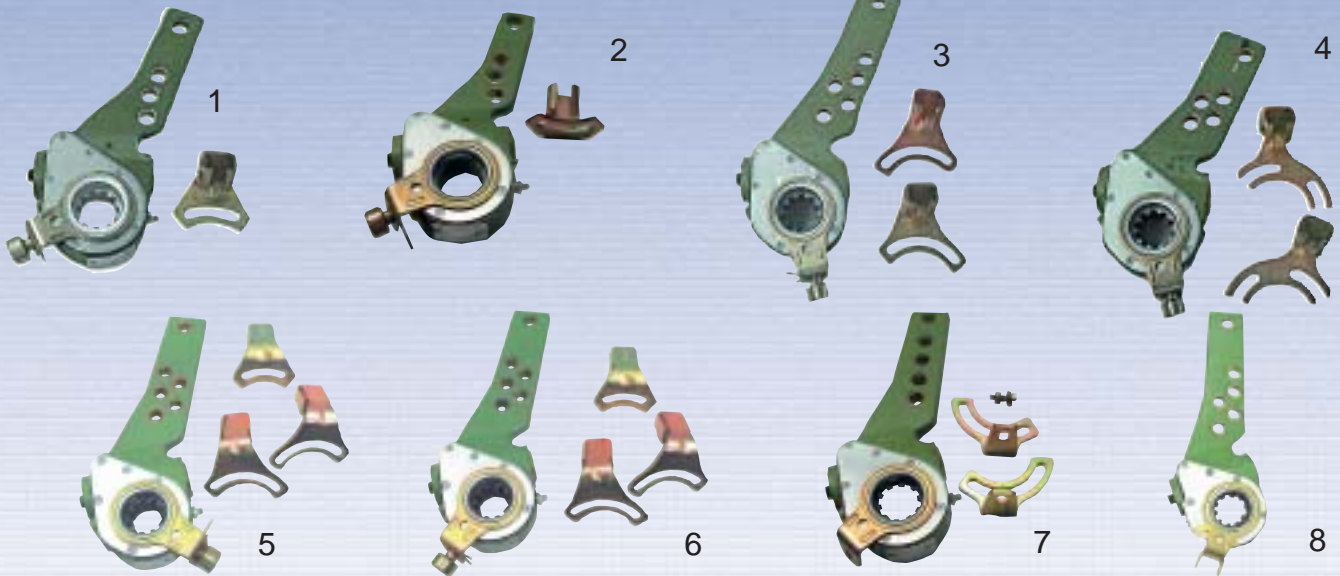

| FOTO | APLICACIÓN | REF. AIR-FREN | REF. HALDEX | FUNDICIÓN | UNIDAD DE CONTROL | POSICIÓN | REF. ORIGINAL | ESTRÍAS / SPLINES |
|------|-----------------|---------------|-------------|-----------|-------------------|-----------------|--------------------------|-------------------|
| 1 | FRUEHAUF | 13.69004 | 79004 | 4086 | 635 | 1º, 2º, 3º ↔ | 10240 | 10 |
| 2 | FRUEHAUF | 13.69022 | 79022 | 4086 | 635 | 1º, 2º, 3º ↔ | - | 37 |
| 3 | LECIÑENA | 13.69112 | 79112 | 4076 | 738 | 1º, 2º, 3º ↔ | 4120060000 | 10 |
| 4 | LECITRAILER ROR | 13.62788 | 72788 | 4097 | 808 | 1º, 2º, 3º ↔ | 5820048 | 10 |
| 5 | BPW | 13.62875 | 72875 | 4076 | 616 | 1º, 2º, 3º ↔ | 05.174.82.21.2 | 10 |
| 6 | BPW | 13.62876 | 72876 | 4076 | 617 | 1º, 2º, 3º ↔ | 05.174.82.24.2 | 10 |
| 7 | SAF | 13.62250 | 72250/72948 | 4032 | 632 / 635 | 1º, 2º, 3º ↔ | 4175008501 4175024000 | 10 |
| 8 | SAF | 13.69331 | 79331 | 4076 | 635 | 1º, 2º, 3º ↔ | 4175024900 | 10 |

Unidades de control / Control units

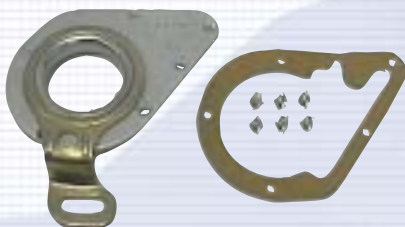

| | | | | | |
|--------|--------|--------|--------|--------|--------|
| 13.228 | 13.374 | 13.555 | 13.565 | 13.688 | 13.854 |
| 13.229 | 13.444 | 13.556 | 13566 | 13.738 | 13.861 |
| 13.230 | 13.448 | 13.557 | 13.635 | 13.782 | 13.864 |
| 13.234 | 13.453 | 13.558 | 13.682 | 13.788 | 13.992 |
| 13.235 | 13.472 | 13.560 | 13.686 | 13.802 | |
| 13.372 | 13.476 | 13.564 | 13.687 | 13.808 | |

PALANCAS AUTOMÁTICAS DE FRENO /

AUTOMATIC SLACK ADJUSTERS

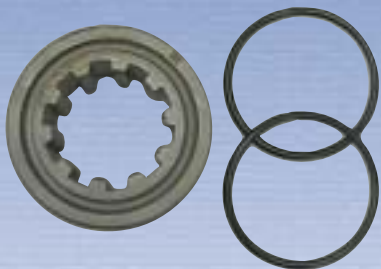

Coronas / Crowns

| REF. AIR-FREN | Nº ESTRIAS Nº SPLINES |
|---------------|--------------------------|
| 13.53008 | 10 |



| REF. AIR-FREN | Nº ESTRIAS Nº SPLINES |
|---------------|--------------------------|
| 13.37263 | 26 |
| 13.37359 | 27 |
| 13.47369 | 28 |

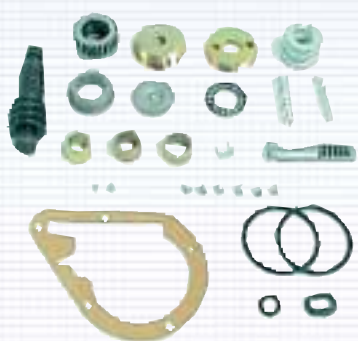

Kit reparación / Repair kit

| REF. AIR-FREN | REF. HALDEX |
|---------------|-------------|
| 13.66046 | 76046 |

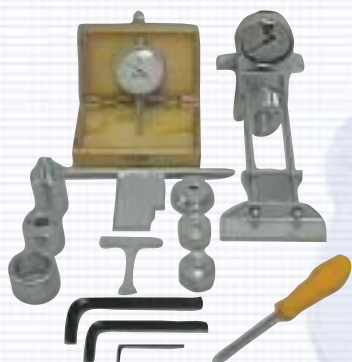

Caja de herramientas / Tools box

| REF. AIR-FREN | REF. HALDEX |
|---------------|-------------|
| 13.76906 | 78340 |

14

OTROS PRODUCTOS
OTHER PRODUCTS



CTO. PIE DE APOYO PARA SUSPENSIÓN MECÁNICA
LANDING GEAR FOR MECHANICA SUSPENSION

REF. AIR-FREN

14.2400.20

ESPECIFICACIONES TÉCNICAS / DETAILS
(POR CONJUNTO)

Capacidad / Capacity 28.000 kgs.
 Carga estática / Static load 80.000 kgs.
 Peso / Weight 105 kgs.

ELEVACIÓN POR VUELTA

- Lenta: 1 mm.
 - Rápida: 11 mm.

ESPECIFICACIONES TÉCNICAS / DETAILS
(POR CONJUNTO)

FUERZA MANUAL EN MARCHA CARGA

| | Mando un lado | Mando ambos lados |
|-------|---------------|-------------------|
| 28 Tn | 35,5 kgs | 18 kg |

Principales medidas / Details

Altura desde barra de unión hasta suelo (recogida) / Height H= 853 mm.
 Recorrido máx. / Stroke 480 mm.

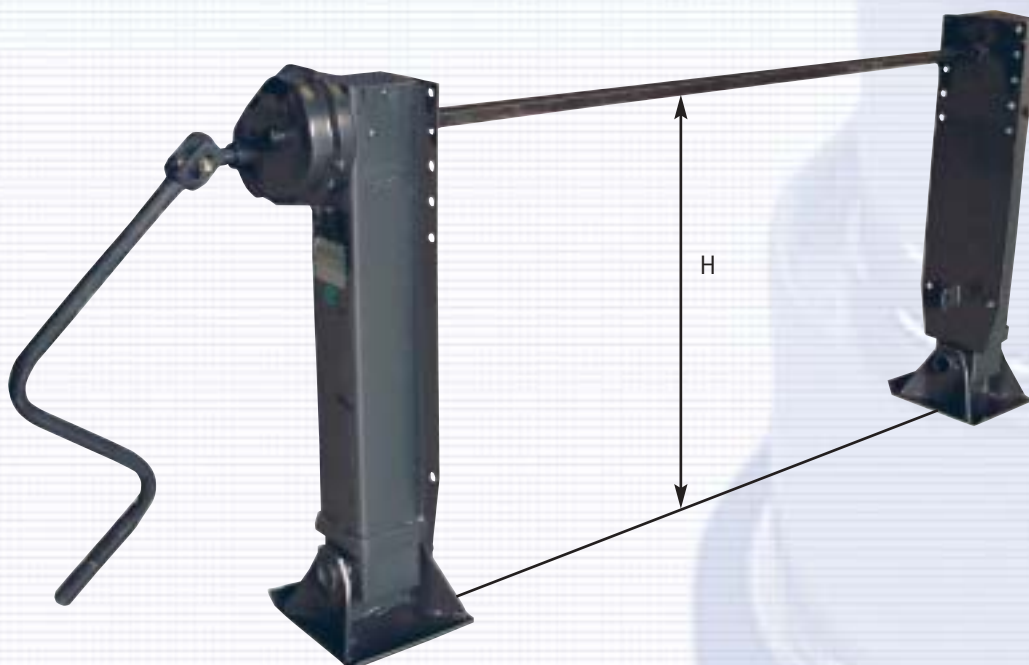

**CTO. PIE DE APOYO PARA SUSPENSIÓN NEUMÁTICA
LANDING GEAR FOR PNEUMATICAL SUSPENSION**

REF. AIR-FREN

14.8200.20

**ESPECIFICACIONES TÉCNICAS / DETAILS
(POR CONJUNTO)**

Capacidad / Capacity 28.000 kgs.
Carga estática / Static load 80.000 kgs.
Peso / Weight 105 kgs.

ELEVACIÓN POR VUELTA

- Lenta: 1 mm.
- Rápida: 11 mm.

**ESPECIFICACIONES TÉCNICAS / DETAILS
(POR CONJUNTO)**

FUERZA MANUAL EN MARCHA CARGA

| | Mando un lado | Mando ambos lados |
|-------|---------------|-------------------|
| 28 Tn | 35,5 kgs | 18 kg |

Principales medidas / Details

Altura desde barra de unión hasta suelo (recogida) / Height H= 890 mm.
Recorrido máx. / Stroke 480 mm.

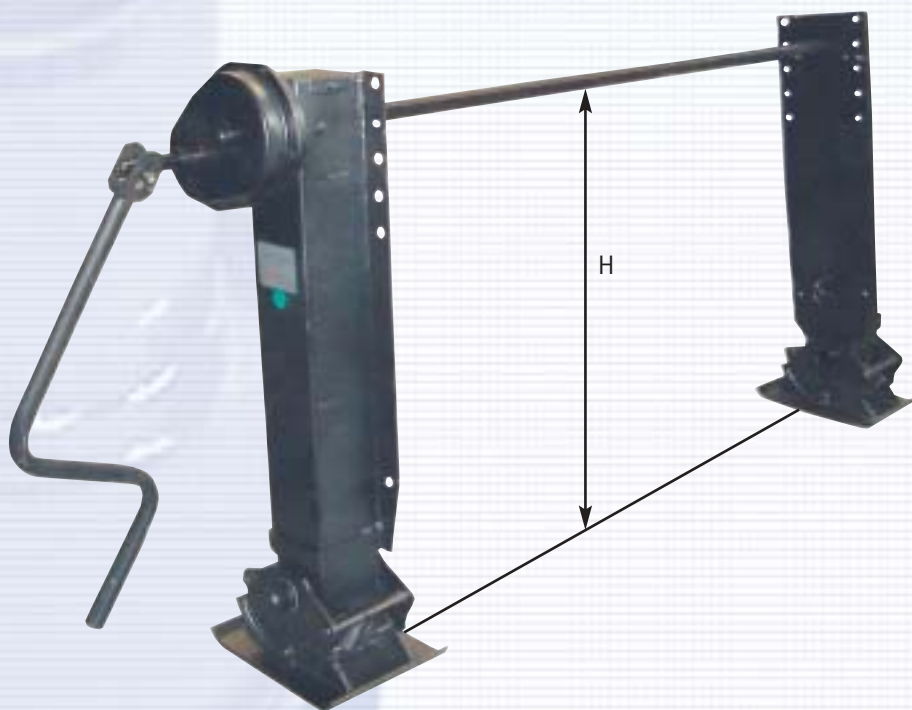

CTO. PIE DE APOYO PATIN LG CORTA - 20 AGUJEROS
LANDING GEAR (SHORT AND 20 HOLES)

REF. AIR-FREN

14.5100.20

ESPECIFICACIONES TÉCNICAS / DETAILS
 (POR CONJUNTO)

Capacidad / Capacity 24.000 kgs.
 Carga estática / Static load 50.000 kgs.
 Peso / Weight 105 kgs.

ELEVACIÓN POR VUELTA

- Lenta: 1mm.
 - Rápida: 11 mm.

Principales medidas / Details

Altura desde barra de unión hasta suelo
 (recogida) / Height H= 750 mm.
 Recorrido máx. / Stroke 480 mm.

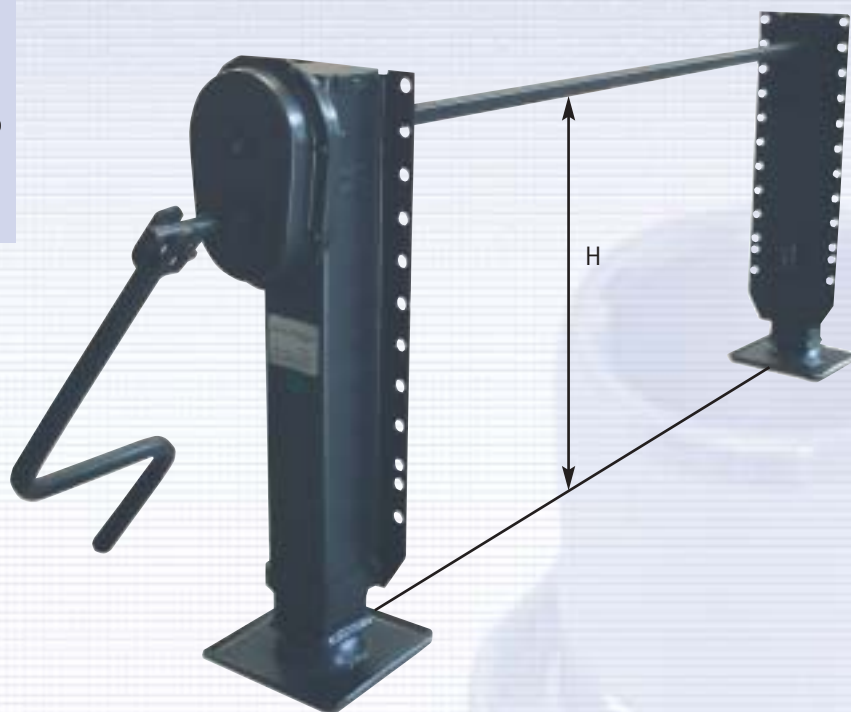

Racores para conexión VOSS / Conector type VOSS

| DESCRIPCIÓN RACOR | REF. AIR-FREN |
|---------------------------------|---------------|
| Racor de M16x1,5 A H16x1,5 VOSS | 14.5001616 |
| Racor de M22x1,5 A H22x1,5 VOSS | 14.5002222 |
| Racor de M12x1,5 A H16x1,5 VOSS | 14.5001216 |
| Racor de M16x1,5 A H22x1,5 VOSS | 14.5001622 |
| Racor de M22x1,5 A H16x1,5 VOSS | 14.5002216 |

M: Macho / Male
H: Hembra / Female

Racor hembra tipo VOSS 230 / Female Quick connect system 230

| REF. AIR-FREN | DESCRIPCIÓN RACOR |
|---------------|--------------------------|
| 14.9250.10 | M16 + Gomas / with seals |
| 14.9250.20 | M22 + Gomas / with seals |

Tipo / Type: 230 VOSS

Kit juntas VOSS 230/240 D.9

| REF. AIR-FREN | PARA: |
|---------------|--------------|
| 14.9590.10 | MAN IVECO |

Kit juntas VOSS 230/240 D.13

| REF. AIR-FREN | PARA: |
|---------------|--------------|
| 14.9590.20 | MAN IVECO |

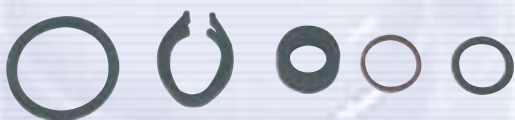
Kit juntas VOSS 230/240 M16x150

| REF. AIR-FREN | PARA: |
|---------------|----------|
| 14.9590.30 | MERCEDES |

Kit juntas VOSS 230/240 M22x150

| REF. AIR-FREN | PARA: |
|---------------|----------|
| 14.9590.40 | MERCEDES |

Juntas de cierre cabeza acoplamiento / Palm coupling seal



| REF. AIR-FREN | REF. TACA |
|---------------|----------------|
| 14.4315 | 247.648.02.081 |



| REF. AIR-FREN | REF. WABCO |
|---------------|------------|
| 14.4315.1 | 401.394.1 |



| REF. AIR-FREN | REF. FRUEHAUF |
|---------------|---------------|
| 14.4315.2 | 72014 |



Tuerca de rueda / Flange nut

| REF. AIR-FREN | REF. PEGASO |
|---------------|-------------|
| 14.21.500 | 716.661 |



Conjunto codo / Oil valve

| REF. AIR-FREN | REF. PEGASO |
|---------------|-------------|
| 14.773.049 | 773.049 |

Embolos / Seats
**KIT V/REGULADORA
EN FUNCIÓN DE CARGA**
REF. AIR-FREN

402.636.7

14.636.7

KIT V/TANDEM FRENO
REF. AIR-FREN

403.610.8

14.610.8

**KIT V/CONTROL
REMOLQUE**
REF. AIR-FREN

401.600.3

14.600.3

KIT V/MANO MVS
REF. AIR-FREN

401.330.7

14.2371.6

KIT SERVOEMBRAGUE
REF. AIR-FREN

401.586.6

14.4855.14

KIT M.V.R
REF. AIR-FREN

961.722.003.2

14.9042

KIT SERVOEMBRAGUE
REF. AIR-FREN

970.051.906.2

14.9062

KIT V/PEDAL
REF. AIR-FREN

I-80450

14.800.0

**KIT V/REGULADORA
EN FUNCIÓN DE CARGA**
REF. AIR-FREN

475.712.000.2

14.712.0

KIT V/CONTROL REMOLQUE
REF. AIR-FREN

973.009.000.2

14.900.0

973.008.000.2

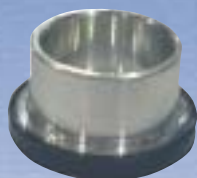

KIT SERVOEMBRAGUE

REF. AIR-FREN

970.051.307.0

14.9432

Collarín para V/Relé / Seal for Relay valve

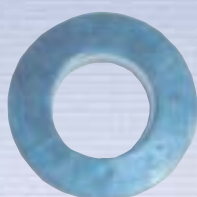

KIT V / RELÉ

REF. AIR-FREN

973.011.000.2

14.5020



1



2



3



4



5

Palancas de freno manuales / Manual slack adjusters

| FOTO | REF. AIR-FREN | REF. ILASA | REF. LECIÑENA | REF. FRUEHAUF |
|------|---------------|------------|---------------|---------------|
| 1 | 14.I.8C | 9902413 | - | - |
| 2 | 14.I.8L | 9901413 | - | - |
| 3 | 14.L.10C | - | 412.130 | - |
| 4 | 14.L.10L | - | 412.132 | - |
| 5 | 14.F.37 | - | - | 10220 |

C- Corta/ Short

L- Larga/ Long

Manguito para V/ALB (8 mm) / Sleeve for ALB valve

| REF. AIR-FREN | REF. WABCO |
|---------------|----------------------------|
| 14.2545.00 | 402.192.4 433.300.381.4 |

Manguito para V/ALB (8 mm) / Sleeve for ALB valve

| REF. AIR-FREN | REF. WABCO |
|---------------|----------------------------|
| 14.2545.10 | 468.444.0 433.300.383.4 |

Manguito para V/Niveladora (6 mm) / Sleeve for level valve

| REF. AIR-FREN | REF. WABCO |
|---------------|----------------------------|
| 14.2545.20 | 401.887.0 433.401.380.4 |

Manguito para V/Niveladora (6 mm) / Sleeve for level valve

| REF. AIR-FREN | REF. WABCO |
|---------------|---------------|
| 14.2545.30 | 433.300.385.4 |

Varilla V/Reguladora ALB / ALB level valve arm

| REF. AIR-FREN | REF. WABCO |
|---------------|---------------|
| 14.2545.40 | 475.701.712.2 |

Varilla V/Reguladora ALB / ALB level valve arm

| REF. AIR-FREN | REF. WABCO |
|---------------|---------------|
| 14.2545.50 | 475.702.710.2 |



| REF. AIR-FREN | DIMENSIÓN |
|---------------|-----------|
| 14.5000189 | M12X150 |
| 14.5000161 | M14X150 |
| 14.5000160 | M16X150 |
| 14.5000178 | M18X150 |
| 14.5000188 | M20X150 |
| 14.4340 | M22X150 |
| 14.5405 | M26X150 |

Reductor M16>H22 / Connector



REF. AIR-FREN

14.5865

Reductor M22>H16 / Connector



REF. AIR-FREN

14.5000164



Émbolo para V/pedal Haldex 320.003.103

REF. AIR-FREN

14.2308



Arandela DIG M-22

| REF. AIR-FREN | REF. RENAULT | Ø |
|---------------|--------------|----|
| 14.4710 | 4020826040 | 22 |
| 14.4715 | - | 16 |



| REF. AIR-FREN | DIMENSIÓN |
|---------------|------------|
| 14.5000419 | M12X1'5 mm |
| 14.5000417 | M14X1'5 mm |
| 14.5000422 | M16X1'5 mm |
| 14.5000418 | M22X1'5 mm |



| REF. AIR-FREN | DIMENSIÓN |
|---------------|------------|
| 14.5000428 | 1/4 GAS |
| 14.5000427 | M12X1'5 mm |
| 14.5000426 | M14X1'5 mm |
| 14.5000424 | M16X1'5 mm |
| 14.5000425 | M16X1'0 mm |
| 14.5000423 | M18X1'5 mm |
| 14.5000421 | M22X1'5 mm |



| REF. AIR-FREN | REF. WABCO |
|---------------|---------------|
| 14.7031.00 | 463.703.100.0 |

DAF, MAN, IVECO, MERCEDES, VOLVO



Conjunto cono / SEAT

| REF. AIR-FREN | SEAT FOR / REPARER |
|---------------|--------------------|
| 14.1902 | GRAU - 950.320.010 |



Contactador de pare / Contactor

| REF. AIR-FREN |
|---------------|
| 14.6010.10 |



Contactador de pare / Contactor

| REF. AIR-FREN |
|---------------|
| 14.8002.10 |

15



CONEXIONES ELÉCTRICAS

ELECTRICAL COILS

ESPIRALES ELÉCTRICAS ABS / ABS ELECTRICAL COILS

De acuerdo con ISO 7638 / *In accordance with ISO 7638*

Aprobado por GGVS/ADR / *GGVS-ADR aproved*

5 polos / *5 core*

Longitud: 4 m / *Working Lenght: 4 m*

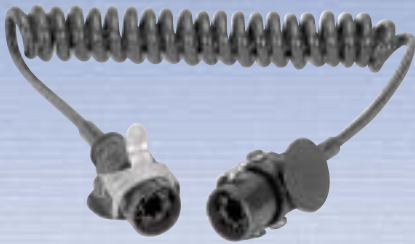

REF. AIR-FREN

15.4500.10

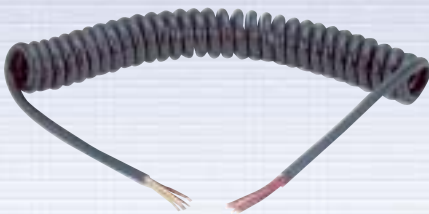

REF. AIR-FREN

15.4600.10

CONECTORES / PLUGS AND SOCKETS



REF. AIR-FREN

15.4500.11



REF. AIR-FREN

15.4500.12

ESPIRALES ELÉCTRICAS EBS / *EBS ELECTRICAL COILS*

De acuerdo con ISO 7638 / *In accordance with ISO 7638*

Aprobado por GGVS/ADR / *GGVS-ADR aproved*

7 polos / *7 core*

Longitud: 4 m / *Working Lenght: 4 m*



REF. AIR-FREN

15.4700.10



REF. AIR-FREN

15.4800.10

CONECTORES / *PLUGS AND SOCKETS*



REF. AIR-FREN

15.4700.11



REF. AIR-FREN

15.4700.12

ESPIRALES ELÉCTRICAS / ELECTRICAL COILS

13 polos / 13 core

24 voltios / 24 v.

Longitud: 4 m / Working Length: 4 m

Aprobado por GGVS/ADR / GGVS-ADR approved



REF. AIR-FREN

15.5800.10

ESPIRALES ELÉCTRICAS / ELECTRICAL COILS

15 polos / 15 core

24 voltios / 24 v.

Longitud: 4 m / Working Length: 4 m

De acuerdo con ISO 12098 / In accordance with ISO 12098



REF. AIR-FREN

15.5900.10

ESPIRAL ADAPTADORA / ADAPTER COIL

1 Conector 15 polos ISO 12098 / 1 plug 15 core

1 Conector aluminio 7 polos 24 v, tipo N ISO 1185 /

1 Aluminium plug, 7 core type N

1 Conector aluminio 7 polos 24 v, tipo S ISO 3731 /

1 Aluminium plug, 7 core type S



REF. AIR-FREN

15.5700.10

CONECTORES / PLUGS AND SOCKETS



| REF. AIR-FREN | CARACTERÍSTICAS / DETAILS |
|---------------|--|
| 15.5800.11 | 13 polos / 13 core ISO 12098 24 voltios / 24 v |



| REF. AIR-FREN | CARACTERÍSTICAS / DETAILS |
|---------------|--|
| 15.5800.12 | 13 polos / 13 core ISO 12098 24 voltios / 24 v |



| REF. AIR-FREN | CARACTERÍSTICAS / DETAILS |
|---------------|--|
| 15.5900.11 | 15 polos / 15 core ISO 12098 24 voltios / 24 v |



| REF. AIR-FREN | CARACTERÍSTICAS / DETAILS |
|---------------|--|
| 15.5900.12 | 15 polos / 15 core ISO 12098 24 voltios / 24 v |

ESPIRALES ELÉCTRICAS / ELECTRICAL COILS

Tipo aluminio / Aluminium type

24 voltios / 24 v.

Tipo N / N type

ISO 1185

7 polos / 7 core

Longitud: 4 m / Working Length: 4 m



REF. AIR-FREN

15.7200.10

ESPIRALES ELÉCTRICAS / ELECTRICAL COILS

Tipo aluminio / Aluminium type

24 voltios / 24 v.

Tipo S / S type

ISO 3731

7 polos / 7 core

Longitud: 4 m / Working Length: 4 m



REF. AIR-FREN

15.7300.10



REF. AIR-FREN

15.7400.10

CONECTORES / PLUGS AND SOCKETS



| REF. AIR-FREN | CARACTERÍSTICAS / DETAILS |
|---------------|---|
| 15.7200.11 | Tipo aluminio / Aluminium type 24 voltios / 24 v Tipo N / N Type ISO 1185 7 polos / 7 core screw terminal |



| REF. AIR-FREN | CARACTERÍSTICAS / DETAILS |
|---------------|---|
| 15.7200.12 | Tipo aluminio / Aluminium type 24 voltios / 24 v Tipo N / N Type ISO 1185 7 polos / 7 core screw terminal |



| REF. AIR-FREN | CARACTERÍSTICAS / DETAILS |
|---------------|---|
| 15.7300.11 | Tipo aluminio / Aluminium type 24 voltios / 24 v Tipo S / S Type ISO 3731 7 polos / 7 core screw terminal |



| REF. AIR-FREN | CARACTERÍSTICAS / DETAILS |
|---------------|---|
| 15.7300.12 | Tipo aluminio / Aluminium type 24 voltios / 24 v Tipo S / S Type ISO 3731 7 polos / 7 core screw terminal |

CONECTORES / PLUGS AND SOCKETS



| REF. AIR-FREN | CARACTERÍSTICAS / DETAILS |
|---------------|---|
| 15.7200.13 | Tipo plástico / <i>Plastic type</i> 24 voltios / 24 v Tipo N / <i>N Type</i> ISO 1185 7 polos / 7 core screw terminal |



| REF. AIR-FREN | CARACTERÍSTICAS / DETAILS |
|---------------|---|
| 15.7200.14 | Tipo plástico / <i>Plastic type</i> 24 voltios / 24 v Tipo N / <i>N Type</i> ISO 1185 7 polos / 7 core screw terminal |



| REF. AIR-FREN | CARACTERÍSTICAS / DETAILS |
|---------------|---|
| 15.7300.13 | Tipo plástico / <i>Plastic type</i> 24 voltios / 24 v Tipo S / <i>S Type</i> ISO 3731 7 polos / 7 core screw terminal |



| REF. AIR-FREN | CARACTERÍSTICAS / DETAILS |
|---------------|---|
| 15.7300.14 | Tipo plástico / <i>Plastic type</i> 24 voltios / 24 v Tipo S / <i>S Type</i> ISO 3731 7 polos / 7 core screw terminal |

16



RETENES
SEALS



| REF. AIR-FREN | REF. BPW | CARACTERÍSTICAS / TECHNICAL DETAILS |
|---------------|---------------|-------------------------------------|
| 16.6390.00 | 02.5664.26.57 | EJE 9 Tm 125 x 143 x 13 |



| REF. AIR-FREN | REF. BPW | CARACTERÍSTICAS / TECHNICAL DETAILS |
|---------------|---------------|-------------------------------------|
| 16.6390.10 | 02.5664.46.57 | EJE 12 Tm 145 x 167 x 13 |



| REF. AIR-FREN | REF. BPW | CARACTERÍSTICAS / TECHNICAL DETAILS |
|---------------|---------------|-------------------------------------|
| 16.6390.20 | 02.5664.57.00 | EJE 9 Tm ECO 115 x 136,7 x 8/10,5 |



| REF. AIR-FREN | REF. BPW | CARACTERÍSTICAS / TECHNICAL DETAILS |
|---------------|---------------|-------------------------------------|
| 16.6390.30 | 02.5664.58.00 | EJE 12 Tm ECO 135 x 156,7 x 8/10,5 |



| REF. AIR-FREN | REF. FRENLSA | CARACTERÍSTICAS / TECHNICAL DETAILS |
|---------------|--------------|--|
| 16.6490.00 | 122013 | FRENO ELÉCTRICO RETEN CUBO RUEDA 133,3 x 174 x 17 |



| REF. AIR-FREN | REF. FRUEHAUF | CARACTERÍSTICAS / TECHNICAL DETAILS |
|---------------|---------------|-------------------------------------|
| 16.6590.00 | 10336 | EJE PROPAR 107,95 x 153,62 x 17,27 |



| REF. AIR-FREN | REF. FRUEHAUF | CARACTERÍSTICAS / TECHNICAL DETAILS |
|---------------|---------------|--|
| 16.6590.10 | M003125 | ABS EJE SMB 108 x 152,6 x 185 x 19 (antiguo) |



| REF. AIR-FREN | REF. FRUEHAUF | CARACTERÍSTICAS / TECHNICAL DETAILS |
|---------------|---------------|-------------------------------------|
| 16.6590.20 | M077010 | SIN ABS 108 x 152,6 x 160 x 15/16,5 |



| REF. AIR-FREN | REF. FRUEHAUF | CARACTERÍSTICAS / TECHNICAL DETAILS |
|---------------|---------------|-------------------------------------|
| 16.6590.30 | M076995 | ABS EJE SMB 108 x 152,6 x 185 x 9 |

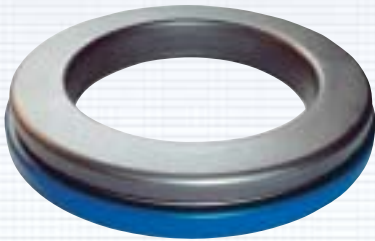

| REF. AIR-FREN | REF. ILASA | CARACTERÍSTICAS / TECHNICAL DETAILS |
|---------------|------------|---|
| 16.6690.00 | 9944514-15 | RETEN EJE PORTAVOLANTES 80,42 x 120 x 14/16,5 |



| REF. AIR-FREN | REF. LECIÑENA | CARACTERÍSTICAS / TECHNICAL DETAILS |
|---------------|---------------|-------------------------------------|
| 16.6790.00 | 3120470000 | 150 x 180 x 12 |



| REF. AIR-FREN | REF. MAN | CARACTERÍSTICAS / TECHNICAL DETAILS |
|---------------|---------------|-------------------------------------|
| 16.6890.00 | 81.96503.0398 | ABS 135 x 175 x 18 |

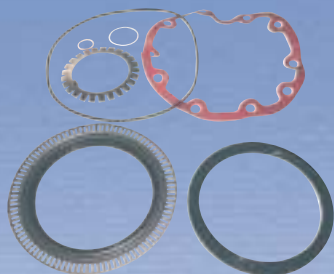

| REF. AIR-FREN | REF. MAN | CARACTERÍSTICAS / TECHNICAL DETAILS |
|---------------|----------|--|
| 16.6890.10 | - | KIT ABS DOS RETENES + ACCESORIOS 145 x 175 x 13,5 145 x 175 x 205 x 9/13 CARDILLA TRASERA MAN/MB C/ ABS ANTIGUO |



| REF. AIR-FREN | REF. MERCEDES | CARACTERÍSTICAS / TECHNICAL DETAILS |
|---------------|---------------|-------------------------------------|
| 16.6990.00 | 0209973947 | ACTROS 145 x 175 x 17 S / ABS |

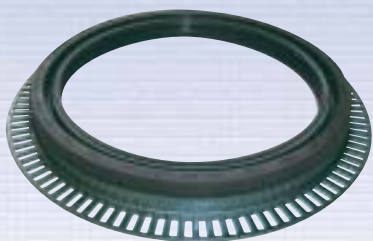

| REF. AIR-FREN | REF. MERCEDES | CARACTERÍSTICAS / TECHNICAL DETAILS |
|---------------|---------------|---|
| 16.6990.10 | 0209970547 | ACTROS 145 x 175 x 205 x 18/20 C / ABS |

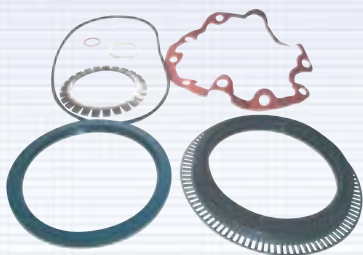

| REF. AIR-FREN | REF. MERCEDES-MAN | CARACTERÍSTICAS / TECHNICAL DETAILS |
|---------------|-------------------|--|
| 16.6990.20 | - | KIT ABS DOS RETENES + ACCESORIOS 145 x 175 x 205 x 18/20 145 x 175 x 13/12 MB ACTROS |

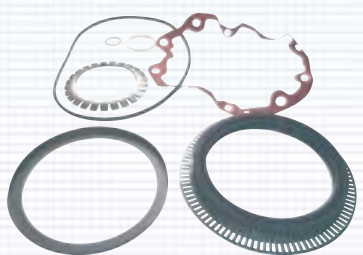

| REF. AIR-FREN | REF. MERCEDES-MAN | CARACTERÍSTICAS / TECHNICAL DETAILS |
|---------------|-------------------|--|
| 16.6990.30 | - | KIT ABS RETEN + COLLARÍN + ACCESORIOS |

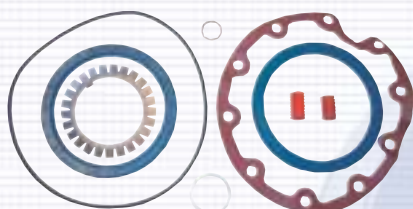

| REF. AIR-FREN | REF. MERCEDES | CARACTERÍSTICAS / TECHNICAL DETAILS |
|---------------|---------------|---|
| 16.6990.40 | 6243560080 | 145 x 175 x 13 145 x 175 x 14 + ACCESORIOS S/ ABS |



| REF. AIR-FREN | REF. MONTENEGRO | CARACTERÍSTICAS / TECHNICAL DETAILS |
|---------------|-----------------|-------------------------------------|
| 16.7090.00 | 061001009 | 152,4 x 177,8 x 12,7 |



| REF. AIR-FREN | REF. ROR | CARACTERÍSTICAS / TECHNICAL DETAILS |
|---------------|----------|-------------------------------------|
| 16.7190.00 | 21200321 | 117,47 x 152,5 x 25 |



| REF. AIR-FREN | REF. ROR | CARACTERÍSTICAS / TECHNICAL DETAILS |
|---------------|----------|-------------------------------------|
| 16.7190.10 | 21220158 | 100 X 135 X 13/15 |



| REF. AIR-FREN | REF. ROR | CARACTERÍSTICAS / TECHNICAL DETAILS |
|---------------|----------|-------------------------------------|
| 16.7190.20 | - | 111,12 X 146,4 X 24 |



| REF. AIR-FREN | REF. ROR | CARACTERÍSTICAS / TECHNICAL DETAILS |
|---------------|----------|-------------------------------------|
| 16.7190.30 | - | 117,47 x 152,5 x 24 |



| REF. AIR-FREN | REF. ROR | CARACTERÍSTICAS / TECHNICAL DETAILS |
|---------------|-----------|-------------------------------------|
| 16.7190.40 | 21200321B | 117,12 X 152,5 X 27 |

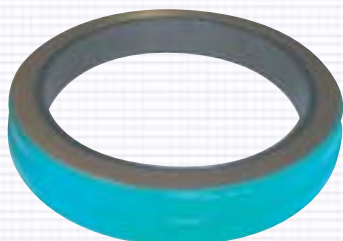

| REF. AIR-FREN | REF. TRAILOR | CARACTERÍSTICAS / TECHNICAL DETAILS |
|---------------|--------------|-------------------------------------|
| 16.7290.00 | 6502085P | 110,12 x 146,5 x 24,3 |

17

**RODAMIENTOS
DE EMBRAGUE**
CLUTCH BEARINGS





| REF. AIR-FREN | REF. DAF | REF. SACHS |
|---------------|---------------------------------------|--------------|
| 17.430.010 | 659320 1267988 279810 514454 | 3151 199 001 |

F1600



| REF. AIR-FREN | REF. DAF | REF. SACHS |
|---------------|----------|------------------------------|
| 17.430.015 | 113365 | 3151 007 303 3151 101 031 |

MB200, MB6, N2800/3300, F2800/3300



| REF. AIR-FREN | REF. DAF | REF. SACHS |
|---------------|------------------|------------------------------|
| 17.430.020 | 658418 658428 | 3151 023 101 1851 117 201 |



| REF. AIR-FREN | REF. DAF | REF. SACHS |
|---------------|--------------------|------------------------------|
| 17.430.025 | 1334350 1287806 | 3151 182 233 3151 182 103 |

DAF 95



| REF. AIR-FREN | REF. DAF | REF. SACHS |
|---------------|----------|------------------------------|
| 17.430.030 | 1303821 | 3151 274 831 3151 157 001 |

DAF CF



| REF. AIR-FREN | REF. DAF | REF. SACHS |
|---------------|--------------------|--|
| 17.430.035 | 1250710 1303975 | 3151 000 034 3151 169 332 3151 273 431 |

IVECO



| REF. AIR-FREN | REF. IVECO | REF. SACHS |
|---------------|---------------------|--|
| 17.440.010 | 1904756 01904756 | 3151 000 144 3151 225 031 3151 203 031 |



| REF. AIR-FREN | REF. IVECO | REF. SACHS |
|---------------|------------|------------------------------|
| 17.440.015 | 42063184 | 3151 007 303 3151 101 031 |



| REF. AIR-FREN | REF. IVECO | REF. SACHS |
|---------------|------------|------------------------------|
| 17.440.020 | 1904779 | 3151 225 031 3151 203 031 |



| REF. AIR-FREN | REF. MAN | REF. SACHS |
|---------------|---------------|--------------|
| 17.450.010 | 81 30550 0087 | 3151 169 332 |



| REF. AIR-FREN | REF. MAN | REF. SACHS |
|---------------|---------------|--------------|
| 17.450.015 | 81 30550 0069 | 3151 152 102 |



| REF. AIR-FREN | REF. MAN | REF. SACHS |
|---------------|---------------|--------------|
| 17.450.020 | 81 30550 0056 | 3151 067 032 |

Tipo largo / Long type



| REF. AIR-FREN | REF. MAN | REF. SACHS |
|---------------|---------------|--------------|
| 17.450.025 | 81 30550 0054 | 3151 067 031 |

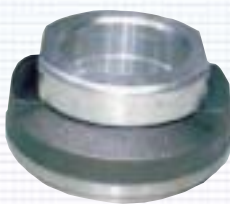

| REF. AIR-FREN | REF. MAN | REF. SACHS |
|---------------|---------------|--------------|
| 17.450.030 | 81 30550 0050 | 3151 066 032 |

Tipo corto / Short type



| REF. AIR-FREN | REF. MAN | REF. SACHS |
|---------------|---------------|------------------------------|
| 17.450.035 | 81 30550 0035 | 3151 007 303 3151 101 031 |



| REF. AIR-FREN | REF. MAN | REF. SACHS |
|---------------|---------------|--------------|
| 17.450.040 | 81 30550 0109 | 3151 000 034 |



Mercedes-Benz



| REF. AIR-FRENI | REF. MERCEDES | REF. SACHS |
|----------------|---------------|--------------|
| 17.460.010 | 001 250 79 15 | 3151 246 031 |

Tipo largo / Long type



| REF. AIR-FRENI | REF. MERCEDES | REF. SACHS |
|----------------|---------------|--------------|
| 17.460.015 | 001 250 88 15 | 3151 245 031 |

Tipo corto / Short type



| REF. AIR-FRENI | REF. MERCEDES | REF. SACHS |
|----------------|---------------|--------------|
| 17.460.020 | 000 250 73 15 | 3151 110 031 |

Tipo largo / Long type



| REF. AIR-FRENI | REF. MERCEDES | REF. SACHS |
|----------------|---------------|--------------|
| 17.460.025 | 000 250 64 15 | 3151 043 032 |

Tipo corto / Short type



| REF. AIR-FRENI | REF. MERCEDES | REF. SACHS |
|----------------|---------------|--------------|
| 17.460.030 | 000 250 77 15 | 3151 027 131 |



Mercedes-Benz



| REF. AIR-FREN | REF. MERCEDES | REF. SACHS |
|---------------|---------------|--------------|
| 17.460.035 | 000 250 76 15 | 3151 126 031 |



| REF. AIR-FREN | REF. MERCEDES | REF. SACHS |
|---------------|---------------|--------------|
| 17.460.040 | 000 250 75 15 | 3151 108 031 |



| REF. AIR-FREN | REF. MERCEDES | REF. SACHS |
|---------------|-------------------------|--------------|
| 17.460.045 | 002 250 41 15 Actros | 3100 002 255 |

Tipo largo / Long type

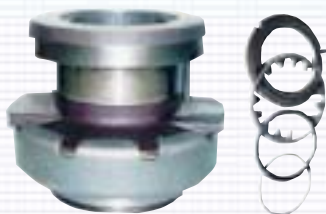

| REF. AIR-FREN | REF. MERCEDES | REF. SACHS |
|---------------|-------------------------|------------------------------|
| 17.460.050 | 002 250 37 15 Actros | 3100 002 254 3151 258 031 |

Tipo corto / Short type



| REF. AIR-FREN | REF. MERCEDES | REF. SACHS |
|---------------|---------------|--------------|
| 17.460.055 | 001 250 81 15 | 3151 241 032 |

Tipo corto / Short type



Mercedes-Benz



| REF. AIR-FREN | REF. MERCEDES | REF. SACHS |
|---------------|---------------|------------------------------|
| 17.460.060 | 002 250 49 15 | 3151 273 731 3151 000 335 |

Kit de montaje / Assembling kit

| REF. AIR-FREN | REF. MERCEDES | REF. SACHS |
|---------------|---------------|--------------|
| 17.460.065 | - | 3180 002 103 |

Kit de montaje / Assembling kit

| REF. AIR-FREN | REF. MERCEDES | REF. SACHS |
|---------------|---------------|--------------|
| 17.460.070 | - | 3180 007 101 |

Kit de montaje / Assembling kit

| REF. AIR-FREN | REF. MERCEDES | REF. SACHS |
|---------------|---------------|--------------|
| 17.460.075 | 000 252 06 46 | 3496 006 000 |

Kit de montaje / Assembling kit

| REF. AIR-FREN | REF. MERCEDES | REF. SACHS |
|---------------|---------------|------------|
| 17.460.080 | 000 252 06 43 | - |



RENAULT



| REF. AIR-FREN | REF. RENAULT | REF. SACHS |
|---------------|--------------|--------------|
| 17.470.010 | 5000807806 | 3151 067 032 |



| REF. AIR-FREN | REF. RENAULT | REF. SACHS |
|---------------|--------------|--------------|
| 17.470.015 | 5000028321 | 3100 008 106 |

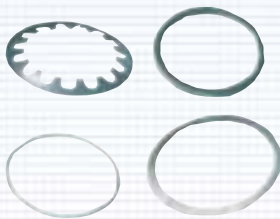

| Kit de montaje / Assembling kit | | |
|---------------------------------|--------------|--------------|
| REF. AIR-FREN | REF. RENAULT | REF. SACHS |
| 17.470.020 | 5001825649 | 3180 002 103 |
| | | 3180 002 102 |
| | | 3180 000 001 |



| REF. AIR-FREN | REF. RENAULT | REF. SACHS |
|---------------|--------------------------|--------------|
| 17.470.025 | 5010244086 5010244204 | 3151 250 332 |
| | | 3151 000 404 |
| | | 3151 274 131 |
| | | 3151 174 131 |
| | | 3151 274 101 |

RENAULT

| REF. AIR-FREN | REF. VALEO | REF. SACHS |
|---------------|------------|--------------|
| 17.470.030 | 262341 | 3151 150 041 |

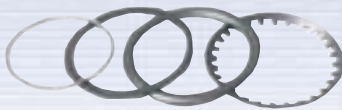
Kit de montaje / Assembling kit

| REF. AIR-FREN | REF. RENAULT | REF. SACHS |
|---------------|--------------|--|
| 17.470.035 | - | 3180 002 103 3180 002 102 3180 000 001 |



| REF. AIR-FREN | REF. RENAULT | REF. SACHS |
|---------------|--------------------------|--------------|
| 17.470.040 | 5010244202 5010244017 | 3151 250 231 |



SCANIA



| REF. AIR-FREN | REF. SCANIA | REF. SACHS |
|---------------|-------------|--------------|
| 17.480.010 | 1393161 | 3100 008 101 |



Kit de montaje / Assembling kit

| REF. AIR-FREN | REF. SCANIA |
|---------------|-------------|
| 17.480.015 | 1393187 |



| REF. AIR-FREN | REF. SCANIA | REF. SACHS |
|---------------|-------------|--------------|
| 17.480.020 | 1455730 | 3182 009 938 |
| | 1522377 | 3182 006 131 |
| | 1434649 | 3182 009 936 |
| | 1393332 | 3182 006 531 |
| | 1123296 | 3182 006 231 |



| REF. AIR-FREN | REF. SCANIA | REF. SACHS |
|---------------|-------------|--------------|
| 17.480.025 | 1499770 | 3151 000 151 |

VOLVO



| REF. AIR-FREN | REF. VOLVO | REF. SACHS |
|---------------|------------|--------------|
| 17.490.010 | 1527693 | 3151 106 041 |

F10, F12, N10, N12

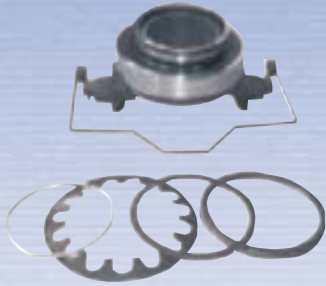

| REF. AIR-FREN | REF. VOLVO | REF. SACHS |
|---------------|------------|--------------|
| 17.490.015 | 1669833 | 3100 002 220 |
| | 1655732 | |
| | 1655825 | |
| | 1667258 | |
| | 1668923 | |
| | 8112159 | |
| | 1672946 | |

Tipo largo / Long type

FE7, FS7, FL7, F10, FL10, N10, NL10S, F12, FL12, FH12, B10, B12



| REF. AIR-FREN | REF. VOLVO | REF. SACHS |
|---------------|------------|--------------|
| 17.490.020 | 3192222 | 3100 002 247 |
| | 1655843 | |
| | 1668921 | |
| | 1669832 | |
| | 1672944 | |

Tipo corto / Short type

FE7, FS7, FL7, F10, FL10, N10, NL10S, F12, FL12, FH12, B10, B12

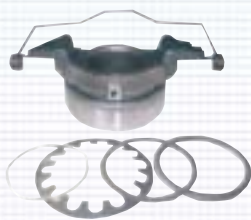

| REF. AIR-FREN | REF. VOLVO | REF. SACHS |
|---------------|------------|--------------|
| 17.490.025 | 1655732 | 3100 002 220 |

Con engrase. Tipo largo / With oil drain valve. Long type

FL7, F10, FL10, N10, F12, FL12, N12, NL12S, F16, FH12, FH16, B10

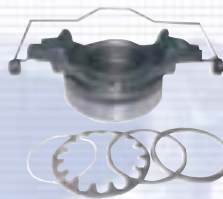

| REF. AIR-FREN | REF. VOLVO | REF. SACHS |
|---------------|--------------------|--------------|
| 17.490.030 | 1655843 1672944 | 3100 002 247 |

Con engrase. Tipo corto / With oil drain valve. Short type

FL7, F10, FL10, N10, F12, FL12, N12, NL12S, F16, FH12, FH16, B10

Kit de montaje / Assembling kit

| REF. AIR-FREN | REF. VOLVO | REF. SACHS |
|---------------|---------------------|------------------------------|
| 17.490.035 | 1655829 20571946 | 3180 001 008 3180 001 018 |

18

KITS REPARACIÓN CALIPER
CALIPER REPAIR KITS

KITS REPARACIÓN CALIPER / CALIPER REPAIR KITS

Tipo Wabco 17.5" / Wabco 17.5" Type



| | |
|---------------|--------------------------------|
| DESCRIPCIÓN | Kit pernos y bujes deslizantes |
| REF. AIR-FREN | 18.R175.020 |
| REF. ORIGINAL | - |

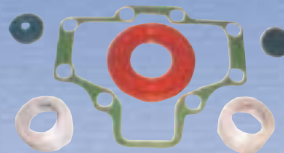

| | |
|---------------|----------------|
| DESCRIPCIÓN | Kit reparación |
| REF. AIR-FREN | 18.R175.010 |
| REF. ORIGINAL | - |



| | |
|---------------|-----------------------|
| DESCRIPCIÓN | Placa de presión |
| REF. AIR-FREN | 18.R175.030 Derecha |
| REF. AIR-FREN | 18.R175.035 Izquierda |

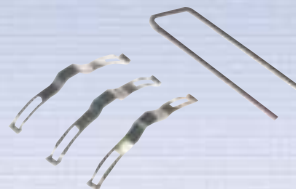

| | |
|---------------|-------------------------|
| DESCRIPCIÓN | Kit seguros antirruídos |
| REF. AIR-FREN | 18.R175.015 |
| REF. ORIGINAL | - |



| | |
|---------------|---------------------------|
| DESCRIPCIÓN | Kit tornillos de fijación |
| REF. AIR-FREN | 18.R175.050 |
| REF. ORIGINAL | - |



| | |
|---------------|-----------------|
| DESCRIPCIÓN | Bulón regulador |
| REF. AIR-FREN | 18.R175.040 |
| REF. ORIGINAL | - |



| | |
|---------------|-------------|
| DESCRIPCIÓN | Kit tapas |
| REF. AIR-FREN | 18.R175.055 |
| REF. ORIGINAL | - |



| | |
|---------------|---------------------------|
| DESCRIPCIÓN | Kit rodamientos y cubetas |
| REF. AIR-FREN | 18.R175.025 |
| REF. ORIGINAL | - |



| | |
|---------------|----------------------|
| DESCRIPCIÓN | Muelle de regulación |
| REF. AIR-FREN | 18.R175.060 |
| REF. ORIGINAL | - |



| | |
|---------------|----------------------|
| DESCRIPCIÓN | Núcleo de regulación |
| REF. AIR-FREN | 18.R175.045 |
| REF. ORIGINAL | - |

**Tipo Knorr Bremse SB6000/7000
Knorr Bremse SB6000/7000 type**

| | |
|---------------|------------------------|
| DESCRIPCIÓN | Kit pernos deslizantes |
| REF. AIR-FREN | 18.R650.020 |
| REF. ORIGINAL | - |



| | |
|---------------|----------------|
| DESCRIPCIÓN | Kit reparación |
| REF. AIR-FREN | 18.R650.010 |
| REF. ORIGINAL | - |

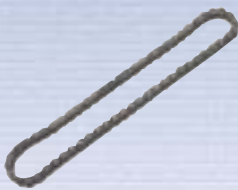

| | |
|---------------|----------------------|
| DESCRIPCIÓN | Cadena de regulación |
| REF. AIR-FREN | 18.R650.055 |
| REF. ORIGINAL | - |



| | |
|---------------|----------------|
| DESCRIPCIÓN | Kit reparación |
| REF. AIR-FREN | 18.R650.005 |
| REF. ORIGINAL | K000944 |

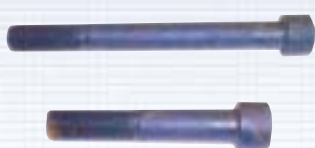

| | |
|---------------|---------------------------|
| DESCRIPCIÓN | Kit tornillos de fijación |
| REF. AIR-FREN | 18.R650.045 |
| REF. ORIGINAL | - |

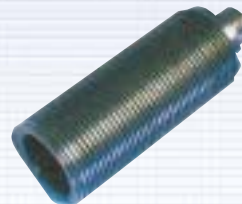

| | |
|---------------|-----------------|
| DESCRIPCIÓN | Bulón regulador |
| REF. AIR-FREN | 18.R650.060 |
| REF. ORIGINAL | - |



| | |
|---------------|-------------------|
| DESCRIPCIÓN | Bancada de núcleo |
| REF. AIR-FREN | 18.R650.040 |
| REF. ORIGINAL | - |

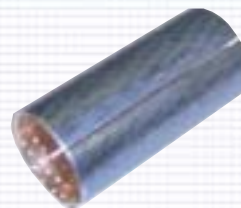

| | |
|---------------|-----------------------|
| DESCRIPCIÓN | Kit bujes deslizantes |
| REF. AIR-FREN | 18.R650.050 |
| REF. ORIGINAL | - |



| | |
|---------------|------------------------------|
| DESCRIPCIÓN | Núcleo bulones de regulación |
| REF. AIR-FREN | 18.R650.065 |
| REF. ORIGINAL | - |



| | |
|---------------|-------------------------|
| DESCRIPCIÓN | Kit seguros antirruídos |
| REF. AIR-FREN | 18.R650.015 |
| REF. ORIGINAL | - |

KITS REPARACIÓN CALIPER / CALIPER REPAIR KITS



| | |
|---------------|--------------------------|
| DESCRIPCIÓN | Kit fuelle y perno corto |
| REF. AIR-FREN | 18.R650.035 |
| REF. ORIGINAL | - |



| | |
|---------------|-------------|
| DESCRIPCIÓN | Tapa |
| REF. AIR-FREN | 18.R650.030 |
| REF. ORIGINAL | - |



| | |
|---------------|---------------------------|
| DESCRIPCIÓN | Kit rodamientos y cubetas |
| REF. AIR-FREN | 18.R650.025 |
| REF. ORIGINAL | - |



| | |
|---------------|--------------------|
| DESCRIPCIÓN | Kit guías y juntas |
| REF. AIR-FREN | 18.R650.070 |
| REF. ORIGINAL | 1132809/0062 |



| | |
|---------------|--------------------|
| DESCRIPCIÓN | Kit guías y juntas |
| REF. AIR-FREN | 18.R650.075 |
| REF. ORIGINAL | K000375 |



| | |
|---------------|---------------------------------|
| DESCRIPCIÓN | Kit casquillo con tapa metálica |
| REF. AIR-FREN | 18.R650.080 |
| REF. ORIGINAL | K000696 |



| | |
|---------------|--|
| DESCRIPCIÓN | Eje mecanismo de ajuste izquierdo |
| REF. AIR-FREN | 18.R650.085 |
| REF. ORIGINAL | - |
| INFORMACIÓN | Para / For: SB5... SB6... SB7... SN... |

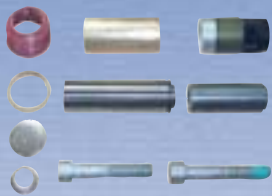

| | |
|---------------|--|
| DESCRIPCIÓN | Eje mecanismo de ajuste derecho |
| REF. AIR-FREN | 18.R650.090 |
| REF. ORIGINAL | - |
| INFORMACIÓN | Para / For: SB5... SB6... SB7... SN... |

**Tipo Knorr Bremse SN6000/7000
Knorr Bremse SN6000/7000 type**

| | |
|---------------|--------------------|
| DESCRIPCIÓN | Kit guías y juntas |
| REF. AIR-FREN | 18.R750.030 |
| REF. ORIGINAL | K000472 |

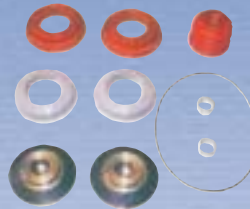

| | |
|---------------|----------------|
| DESCRIPCIÓN | Kit reparación |
| REF. AIR-FREN | 18.R750.010 |
| REF. ORIGINAL | - |



| | |
|---------------|------------------------|
| DESCRIPCIÓN | Kit pernos deslizantes |
| REF. AIR-FREN | 18.R750.015 |
| REF. ORIGINAL | - |

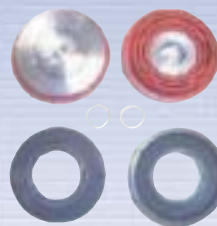

| | |
|---------------|----------------|
| DESCRIPCIÓN | Kit reparación |
| REF. AIR-FREN | 18.R750.005 |
| REF. ORIGINAL | K001300 |

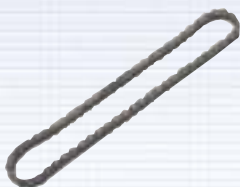

| | |
|---------------|----------------------|
| DESCRIPCIÓN | Cadena de regulación |
| REF. AIR-FREN | 18.R650.055 |
| REF. ORIGINAL | - |

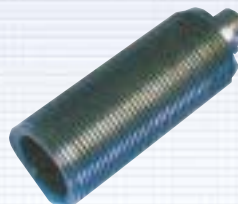

| | |
|---------------|-----------------|
| DESCRIPCIÓN | Bulón regulador |
| REF. AIR-FREN | 18.R650.060 |
| REF. ORIGINAL | - |



| | |
|---------------|-------------|
| DESCRIPCIÓN | Kit tapas |
| REF. AIR-FREN | 18.R750.025 |
| REF. ORIGINAL | - |

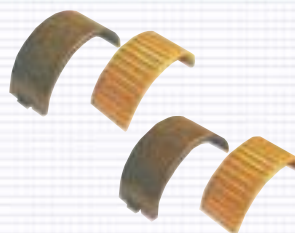

| | |
|---------------|---------------------------|
| DESCRIPCIÓN | Kit rodamientos y cubetas |
| REF. AIR-FREN | 18.R750.020 |
| REF. ORIGINAL | - |



| | |
|---------------|-------------------------|
| DESCRIPCIÓN | Kit seguros antirruídos |
| REF. AIR-FREN | 18.R650.015 |
| REF. ORIGINAL | - |

Meritor - LRG

536/537/552/553/560/561/596/597/598/599/648/649



| | |
|----------------------|--------------------------------|
| DESCRIPCIÓN | Kit reparación calíper trasero |
| REF. AIR-FREN | 18.R850.020 |
| REF. ORIGINAL | MCK1238 |

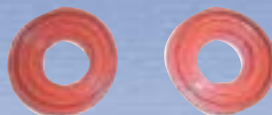

| | |
|----------------------|------------------------------|
| DESCRIPCIÓN | Guardapolvos calíper trasero |
| REF. AIR-FREN | 18.R850.010 |
| REF. ORIGINAL | 6832854PK10 |

19

CRUCE DE REFERENCIAS *CROSS REFERENCE LIST*

| AIR-FREN | | Ref. AIR-FREN | Pág. | Ref. AIR-FREN | Pág. | Ref. AIR-FREN | Pág. |
|-------------|----|---------------|------|---------------|------|---------------|------|
| 01.1024.20 | 15 | 01.1300.130 | 28 | 01.3701.60 | 12 | 01.R391.118 | 58 |
| 01.1024.40 | 15 | 01.1300.135 | 42 | 01.3701.90 | 12 | 01.R391.119 | 36 |
| 01.1024.50 | 15 | 01.1300.140 | 52 | 01.391.002 | 54 | 01.R391.120 | 35 |
| 01.1024.70 | 15 | 01.1300.145 | 52 | 01.391.1000 | 57 | 01.R391.121 | 34 |
| 01.1024.80 | 15 | 01.1300.15 | 17 | 01.391.1050 | 57 | 01.R391.122 | 38 |
| 01.1024.90 | 15 | 01.1300.150 | 52 | 01.391.1100 | 54 | 01.R391.123 | 51 |
| 01.1070.00 | 15 | 01.1300.155 | 32 | 01.391.1150 | 27 | 01.R391.124 | 51 |
| 01.1080.00 | 15 | 01.1300.160 | 34 | 01.391.1200 | 24 | 01.R391.125 | 26 |
| 01.1100.20 | 9 | 01.1300.165 | 38 | 01.391.1250 | 52 | 01.R391.126 | 58 |
| 01.1100.50 | 9 | 01.1300.170 | 40 | 01.391.1300 | 52 | 01.R391.127 | 56 |
| 01.1100.60 | 9 | 01.1300.175 | 39 | 01.391.1350 | 31 | 01.R391.128 | 59 |
| 01.1100.90 | 9 | 01.1300.180 | 44 | 01.391.1400 | 32 | 01.R391.129 | 56 |
| 01.1150.00 | 10 | 01.1300.190 | 31 | 01.391.1450 | 40 | 01.R391.130 | 56 |
| 01.1150.20 | 10 | 01.1300.25 | 18 | 01.391.150 | 17 | 01.R391.131 | 57 |
| 01.1150.60 | 11 | 01.1300.30 | 14 | 01.391.200 | 54 | 01.R391.132 | 57 |
| 01.1150.90 | 11 | 01.1300.35 | 19 | 01.391.300 | 13 | 01.R391.133 | 28 |
| 01.1200.10 | 16 | 01.1300.40 | 20 | 01.391.400 | 16 | 01.R391.134 | 59 |
| 01.1200.100 | 39 | 01.1300.45 | 33 | 01.391.450 | 33 | 01.R391.135 | 59 |
| 01.1200.105 | 28 | 01.1300.50 | 35 | 01.391.500 | 33 | 01.R391.136 | 30 |
| 01.1200.110 | 30 | 01.1300.55 | 36 | 01.391.550 | 36 | 01.R391.137 | 30 |
| 01.1200.115 | 45 | 01.1300.60 | 37 | 01.391.600 | 34 | 01.R391.138 | 27 |
| 01.1200.120 | 46 | 01.1300.65 | 51 | 01.391.650 | 38 | 01.R391.139 | 59 |
| 01.1200.125 | 47 | 01.1300.70 | 51 | 01.391.700 | 51 | 01.R391.140 | 41 |
| 01.1200.130 | 25 | 01.1300.75 | 45 | 01.391.750 | 51 | 01.R391.141 | 52 |
| 01.1200.135 | 27 | 01.1300.80 | 30 | 01.391.800 | 22 | 01.R391.142 | 52 |
| 01.1200.140 | 48 | 01.1300.85 | 23 | 01.391.850 | 56 | 01.R391.143 | 32 |
| 01.1200.145 | 49 | 01.1300.90 | 47 | 01.391.900 | 56 | 01.R391.144 | 60 |
| 01.1200.15 | 17 | 01.1300.95 | 49 | 01.391.950 | 56 | 01.R391.145 | 60 |
| 01.1200.150 | 50 | 01.1500.10 | 9 | 01.3960.00 | 62 | 01.R391.146 | 60 |
| 01.1200.155 | 29 | 01.2060.00 | 62 | 01.3960.100 | 62 | 01.R391.147 | 60 |
| 01.1200.160 | 28 | 01.2060.10 | 62 | 01.3960.60 | 62 | 01.R391.148 | 60 |
| 01.1200.165 | 43 | 01.2060.20 | 62 | 01.4060.10 | 62 | 01.R391.149 | 31 |
| 01.1200.170 | 26 | 01.230.301.6 | 11 | 01.4070.10 | 62 | 01.R391.150 | 40 |
| 01.1200.175 | 31 | 01.230.301.7 | 11 | 01.523.060 | 14 | 02.03561209 | 73 |
| 01.1200.180 | 41 | 01.230.301.8 | 11 | 01.568.840 | 14 | 02.03561409 | 73 |
| 01.1200.185 | 32 | 01.230.303.0 | 11 | 01.7000.10 | 61 | 02.03561609 | 73 |
| 01.1200.190 | 29 | 01.2300.10 | 53 | 01.772.590 | 13 | 02.0900.13 | 73 |
| 01.1200.195 | 40 | 01.2300.20 | 53 | 01.772.938 | 14 | 02.0916.00 | 67 |
| 01.1200.20 | 17 | 01.2300.30 | 53 | 01.772.950 | 14 | 02.0916.30 | 67 |
| 01.1200.210 | 44 | 01.2320.40 | 9 | 01.772.951 | 14 | 02.0916.70 | 69 |
| 01.1200.25 | 16 | 01.2320.80 | 10 | 01.772.952 | 14 | 02.0916.90 | 69 |
| 01.1200.30 | 18 | 01.2320.90 | 10 | 01.772.956 | 14 | 02.0920.00 | 67 |
| 01.1200.35 | 19 | 01.2460.00 | 62 | 01.774.951 | 13 | 02.0920.30 | 67 |
| 01.1200.40 | 20 | 01.2460.20 | 62 | 01.R110061 | 33 | 02.0920.70 | 69 |
| 01.1200.45 | 21 | 01.2460.30 | 62 | 01.R178.054 | 61 | 02.1200.13 | 73 |
| 01.1200.50 | 22 | 01.2590.05 | 62 | 01.R192.164 | 61 | 02.1214 | 71 |
| 01.1200.55 | 23 | 01.2760.00 | 62 | 01.R196.052 | 61 | 02.1216 | 71 |
| 01.1200.60 | 33 | 01.2760.40 | 62 | 01.R197694 | 61 | 02.1216.00 | 67 |
| 01.1200.65 | 34 | 01.2760.40E | 62 | 01.R197695 | 61 | 02.1216.30 | 67 |
| 01.1200.70 | 35 | 01.2760.60 | 62 | 01.R391.100 | 16 | 02.1216.70 | 69 |
| 01.1200.75 | 36 | 01.2760.60E | 62 | 01.R391.101 | 17 | 02.1216.90 | 69 |
| 01.1200.80 | 37 | 01.3005.00 | 12 | 01.R391.102 | 55 | 02.1220.00 | 67 |
| 01.1200.85 | 24 | 01.3005.20 | 12 | 01.R391.103 | 13 | 02.1220.30 | 67 |
| 01.1200.90 | 38 | 01.3100.00 | 62 | 01.R391.106 | 55 | 02.1220.70 | 69 |
| 01.1200.95 | 42 | 01.3100.40 | 62 | 01.R391.107 | 55 | 02.1302 | 76 |
| 01.1300.10 | 16 | 01.3100.40A | 62 | 01.R391.109 | 55 | 02.1302.1 | 76 |
| 01.1300.100 | 25 | 01.3100.60 | 62 | 01.R391.110 | 28 | 02.1302.2 | 76 |
| 01.1300.105 | 27 | 01.3100.60A | 62 | 01.R391.111 | 55 | 02.1350.20 | 75 |
| 01.1300.110 | 24 | 01.3100.60E | 62 | 01.R391.112 | 18 | 02.1400.10 | 75 |
| 01.1300.115 | 22 | 01.3701.10 | 12 | 01.R391.113 | 20 | 02.1416.00 | 67 |
| 01.1300.120 | 41 | 01.3701.20 | 12 | 01.R391.114 | 22 | 02.1424.30 | 67 |
| 01.1300.125 | 26 | 01.3701.30 | 12 | 01.R391.115 | 23 | 02.1424.50 | 69 |
| | | 01.3701.40 | 12 | 01.R391.116 | 24 | 02.1424.60 | 69 |
| | | 01.3701.50 | 12 | 01.R391.117 | 58 | 02.1424.70 | 69 |



| Ref. AIR-FREN | Pág. | Ref. AIR-FREN | Pág. | Ref. AIR-FREN | Pág. | Ref. AIR-FREN | Pág. |
|---------------|------|----------------|------|---------------|------|-----------------|------|
| 02.1500.30 | 75 | 02.2024.80 | 68 | 02.R1500 | 75 | 03.R527007 | 81 |
| 02.1600.13 | 73 | 02.2030.00 | 67 | 02.R1600 | 72 | 03.R527009 | 83 |
| 02.1600.20 | 70 | 02.2030.30 | 67 | 02.R1650 | 72 | 03.R527010 | 83 |
| 02.1600.50 | 70 | 02.2030.60 | 69 | 02.R1650E | 72 | 03.R527011 | 83 |
| 02.1601 | 71 | 02.2070.00 | 70 | 02.R1750 | 75 | 03.R527012 | 83 |
| 02.1601K | 71 | 02.2080.00 | 70 | 02.R1800 | 72 | 03.R527015 | 84 |
| 02.1601L | 71 | 02.2224.70 | 69 | 02.R1800E | 70 | 03.R527018 | 84 |
| 02.1601W | 71 | 02.239.009.1 | 65 | 02.R1800M | 70 | 03.R527020 | 85 |
| 02.1609 | 71 | 02.239.012.1 | 65 | 02.R2070 | 70 | 03.R527021 | 84 |
| 02.1609.00 | 66 | 02.239.014.6 | 66 | 02.R2080 | 70 | 03.R527024 | 85 |
| 02.1609L | 71 | 02.239.016.1 | 65 | 02.R5050 | 70 | 03.R527026 | 85 |
| 02.1609W | 71 | 02.239.016.6 | 66 | 02.R5150 | 72 | 03.R627001 | 80 |
| 02.1612 | 71 | 02.239.018.6 | 66 | 02.R5700 | 72 | 03.R627002 | 80 |
| 02.1612.00 | 66 | 02.239.020.1 | 65 | 02.R584.622 | 72 | 03.R627003 | 82 |
| 02.1612.10 | 66 | 02.239.020.1C | 65 | 02.R589.757 | 72 | 04.240.724.0 | 89 |
| 02.1612.20 | 66 | 02.239.020.1EE | 65 | 02.R9000 | 70 | 04.240.726.0 | 89 |
| 02.1612L | 71 | 02.239.020.2 | 65 | 02.R9000E | 70 | 04.240.726.01.0 | 90 |
| 02.1612W | 71 | 02.239.020.6 | 66 | 02.R9000N | 72 | 04.240.726.1 | 89 |
| 02.1614 | 71 | 02.239.022.6 | 66 | 03.105508 | 82 | 04.240.726.10 | 90 |
| 02.1614L | 71 | 02.239.024.1 | 65 | 03.105509 | 82 | 04.240.726.12 | 90 |
| 02.1616 | 71 | 02.239.024.1C | 65 | 03.105510 | 82 | 04.240.726.14 | 90 |
| 02.1616.00 | 67 | 02.239.024.2 | 65 | 03.1900.00 | 79 | 04.240.726.15 | 90 |
| 02.1616.05 | 72 | 02.239.024.6 | 66 | 03.1900.10 | 79 | 04.240.726.16 | 90 |
| 02.1616.06 | 73 | 02.239.030.1 | 65 | 03.1900.20 | 79 | 04.240.726.17 | 89 |
| 02.1616.30 | 67 | 02.239.030.1C | 65 | 03.1900.30 | 79 | 04.240.726.18 | 89 |
| 02.1616.60 | 69 | 02.239.030.6 | 66 | 03.240.654.0 | 80 | 04.240.726.19 | 89 |
| 02.1616K | 71 | 02.239.036.1 | 65 | 03.3070.10 | 82 | 04.240.726.20 | 89 |
| 02.1616L | 71 | 02.239.036.2 | 66 | 03.3070.20 | 82 | 04.240.726.21 | 91 |
| 02.1616W | 71 | 02.2400.13 | 73 | 03.4849.00 | 81 | 04.240.726.22 | 91 |
| 02.1622L | 71 | 02.2424.00 | 67 | 03.491102 | 81 | 04.240.726.23 | 91 |
| 02.1624.00 | 67 | 02.2424.05 | 72 | 03.527001 | 80 | 04.240.726.24 | 91 |
| 02.1624.30 | 67 | 02.2424.06 | 73 | 03.527003 | 80 | 04.240.726.25 | 91 |
| 02.1624.50 | 69 | 02.2424.30 | 67 | 03.527004 | 80 | 04.240.726.26 | 92 |
| 02.1624.60 | 69 | 02.2424.50 | 69 | 03.527005 | 80 | 04.240.726.27 | 92 |
| 02.1624.80 | 68 | 02.2424.60 | 69 | 03.527006 | 81 | 04.240.726.28 | 92 |
| 02.1627L | 71 | 02.2424.70 | 69 | 03.527007 | 81 | 04.240.726.29 | 92 |
| 02.1627W | 71 | 02.2424.80 | 68 | 03.527008 | 81 | 04.240.726.3 | 89 |
| 02.1636L | 71 | 02.2430.00 | 67 | 03.527009 | 83 | 04.240.726.31 | 92 |
| 02.1651 | 71 | 02.2430.30 | 67 | 03.527010 | 83 | 04.240.726.4 | 90 |
| 02.1651L | 71 | 02.2430.50 | 69 | 03.527011 | 83 | 04.240.726.41.0 | 90 |
| 02.1651W | 71 | 02.2430.60 | 69 | 03.527012 | 83 | 04.240.726.5 | 89 |
| 02.1685.91 | 74 | 02.2430.80 | 68 | 03.527013 | 83 | 04.240.726.6 | 89 |
| 02.1701.1 | 74 | 02.2430.80C | 68 | 03.527014 | 83 | 04.240.726.7 | 89 |
| 02.1750.20 | 75 | 02.2700.13 | 73 | 03.527015 | 84 | 04.240.726.8 | 89 |
| 02.1800.00 | 70 | 02.2724.00 | 67 | 03.527016 | 84 | 04.240.726.9 | 89 |
| 02.1800.30 | 70 | 02.2724.30 | 67 | 03.527017 | 84 | 04.3546.00 | 98 |
| 02.1802 | 71 | 02.2730.00 | 67 | 03.527018 | 84 | 04.4100.00 | 93 |
| 02.1802K | 71 | 02.2730.30 | 67 | 03.527019 | 85 | 04.4211.00 | 93 |
| 02.1802L | 71 | 02.3000.13 | 73 | 03.527020 | 85 | 04.4211.10 | 93 |
| 02.1802W | 71 | 02.3024.00 | 67 | 03.527021 | 84 | 04.4212.00 | 93 |
| 02.1805 | 74 | 02.3030.00 | 67 | 03.527022 | 84 | 04.4213.00 | 93 |
| 02.1824.30 | 67 | 02.3030.05 | 72 | 03.527023 | 84 | 04.4214.00 | 94 |
| 02.1824.50 | 69 | 02.3030.06 | 73 | 03.527024 | 85 | 04.4215.00 | 94 |
| 02.1824.70 | 69 | 02.3030.30 | 67 | 03.527025 | 85 | 04.4216.00 | 94 |
| 02.1831.91 | 74 | 02.3030.80 | 68 | 03.527026 | 85 | 04.4217.00 | 94 |
| 02.2000.13 | 73 | 02.3600.13 | 73 | 03.527027 | 81 | 04.4218.00 | 95 |
| 02.2020.00 | 67 | 02.3630.00 | 67 | 03.527028 | 86 | 04.4219.00 | 95 |
| 02.2020.05 | 72 | 02.3630.30 | 67 | 03.527029 | 86 | 04.4220.00 | 95 |
| 02.2020.06 | 73 | 02.6754.00 | 65 | 03.R1900 | 79 | 04.4221.00 | 95 |
| 02.2024.00 | 67 | 02.9000.30 | 70 | 03.R1960 | 82 | 04.4222.00 | 96 |
| 02.2024.30 | 67 | 02.9000.40 | 70 | 03.R2300 | 80 | 04.4224.00 | 96 |
| 02.2024.50 | 69 | 02.9000.91 | 74 | 03.R2300E | 80 | 04.4224.50 | 96 |
| 02.2024.60 | 69 | 02.R1350 | 75 | 03.R4849 | 81 | 04.4225.00 | 97 |
| 02.2024.70 | 69 | 02.R1400 | 75 | 03.R527006 | 81 | 04.4226.00 | 97 |

| Ref. AIR-FREN | Pág. | Ref. AIR-FREN | Pág. | Ref. AIR-FREN | Pág. | Ref. AIR-FREN | Pág. |
|----------------|------|---------------|------|---------------|------|---------------|------|
| 04.4227.00 | 97 | 05.545011 | 110 | 06.4510.00 | 117 | 08.005007 | 137 |
| 04.4228.00 | 95 | 05.545012 | 108 | 06.4516.00 | 118 | 08.005017 | 137 |
| 04.4229.00 | 97 | 05.545013 | 108 | 06.4528.00 | 118 | 08.005018 | 137 |
| 04.4230.00 | 97 | 05.545014 | 108 | 06.4605.00 | 117 | 08.005101 | 137 |
| 04.4231.00 | 97 | 05.545015 | 110 | 06.539110 | 115 | 08.005102 | 137 |
| 04.4232.00 | 98 | 05.545016 | 109 | 06.559110 | 115 | 08.005104 | 137 |
| 04.4233.00 | 98 | 05.545017 | 101 | 06.559120 | 115 | 08.005105 | 137 |
| 04.4234.00 | 96 | 05.545018 | 108 | 06.559130 | 116 | 08.1260.00 | 133 |
| 04.4235.00 | 98 | 05.545019 | 108 | 06.559150 | 116 | 08.1280.00 | 133 |
| 04.4236.00 | 96 | 05.545020 | 108 | 06.559160 | 115 | 08.1281.00 | 133 |
| 04.4238.00 | 96 | 05.545021 | 102 | 06.569110 | 116 | 08.1288.00 | 136 |
| 04.4239.00 | 94 | 05.545022 | 102 | 06.579110 | 116 | 08.1294.00 | 133 |
| 04.565590 | 90 | 05.545023 | 102 | 06.6050.60 | 116 | 08.1295.00 | 133 |
| 04.R240.726.00 | 89 | 05.557001 | 105 | 06.645.526 | 115 | 08.1303.00 | 133 |
| 04.R240.726.41 | 90 | 05.557002 | 105 | 06.R4510 | 117 | 08.1307.00 | 136 |
| 04.R2400 | 89 | 05.557004 | 105 | 06.R4528 | 118 | 08.1310.00 | 133 |
| 04.R4100 | 93 | 05.557005 | 108 | 06.R559120 | 115 | 08.1313.00 | 133 |
| 04.R4212 | 93 | 05.557006 | 108 | 06.R559130 | 116 | 08.1323.00 | 134 |
| 04.R4213 | 93 | 05.557007 | 104 | 06.R6040 | 116 | 08.1325.00 | 134 |
| 04.R4214 | 94 | 05.575537 | 101 | 06.R6050 | 116 | 08.1329.00 | 134 |
| 04.R4238 | 96 | 05.605733 | 103 | 06.R639007 | 115 | 08.1330.00 | 134 |
| 04.R631003 | 93 | 05.605734 | 103 | 06.R639008 | 115 | 08.1345.00 | 136 |
| 04.R631008 | 96 | 05.6120.40 | 107 | 06.R659008 | 115 | 08.1350.00 | 134 |
| 04.R631009 | 90 | 05.6120.50 | 107 | 07.015467 | 123 | 08.1361.00 | 133 |
| 04.R631010 | 95 | 05.700000 | 107 | 07.045522 | 123 | 08.1362.00 | 133 |
| 05.008000 | 105 | 05.711000 | 107 | 07.055522 | 123 | 08.1395.00 | 135 |
| 05.009000 | 105 | 05.712000 | 106 | 07.065522 | 123 | 08.1399.00 | 135 |
| 05.009010 | 105 | 05.714000 | 107 | 07.1335.00 | 125 | 08.1410.00 | 135 |
| 05.009300 | 105 | 05.715000 | 106 | 07.3500.30 | 125 | 08.1411.00 | 136 |
| 05.0651.00 | 109 | 05.7558.00 | 102 | 07.3500.60 | 125 | 08.222.703 | 129 |
| 05.0651.10 | 109 | 05.7558.50 | 107 | 07.3515.00 | 123 | 08.3032.00 | 130 |
| 05.0654.00 | 109 | 05.9710.00 | 102 | 07.3550.20 | 125 | 08.3111.00 | 135 |
| 05.1011.00 | 109 | 05.R008000 | 105 | 07.3600.00 | 124 | 08.3115.00 | 135 |
| 05.1011.10 | 109 | 05.R009000 | 105 | 07.529001 | 124 | 08.413042 | 137 |
| 05.135517 | 101 | 05.R009300 | 105 | 07.561001 | 121 | 08.413043 | 137 |
| 05.235546 | 103 | 05.R035004 | 102 | 07.561002 | 121 | 08.4410.50 | 131 |
| 05.2440.12 | 111 | 05.R5020 | 101 | 07.561003 | 123 | 08.4410.60 | 131 |
| 05.2440.14 | 111 | 05.R5090 | 103 | 07.561005 | 121 | 08.4410.70 | 131 |
| 05.2458.49 | 103 | 05.R545007 | 110 | 07.561006 | 121 | 08.4640.00 | 129 |
| 05.2458.50 | 104 | 05.R545009 | 110 | 07.561007 | 121 | 08.5857240 | 138 |
| 05.2458.51 | 104 | 05.R545011 | 110 | 07.561008 | 121 | 08.5857241 | 138 |
| 05.2750.60 | 103 | 05.R545015 | 110 | 07.561009 | 121 | 08.8010.100 | 132 |
| 05.2750.70 | 103 | 05.R557005 | 108 | 07.561010 | 122 | 08.8010.30 | 129 |
| 05.2750.80 | 103 | 05.R557006 | 108 | 07.561011 | 122 | 08.8010.40 | 130 |
| 05.2750.90 | 103 | 05.R557007 | 104 | 07.7020.60 | 122 | 08.8010.50 | 130 |
| 05.2860.00 | 109 | 05.R633001 | 106 | 07.7020.70 | 122 | 08.8010.60 | 132 |
| 05.2860.10 | 109 | 05.R645002 | 101 | 07.7020.80 | 121 | 08.8010.70 | 132 |
| 05.2863.00 | 109 | 05.R645003 | 102 | 07.7020.90 | 121 | 08.8010.80 | 132 |
| 05.30300 | 102 | 05.R645004 | 102 | 07.7070.20 | 124 | 08.8010.90 | 132 |
| 05.3300.34 | 102 | 05.R645010 | 103 | 07.R1335 | 125 | 08.8718.00 | 138 |
| 05.3300.44 | 102 | 05.R645013 | 101 | 07.R3500 | 125 | 08.8718.10 | 138 |
| 05.3520.18 | 104 | 05.R657000 | 105 | 07.R3550 | 125 | 08.9055.30 | 138 |
| 05.3520.19 | 104 | 05.R657001 | 105 | 07.R3600 | 124 | 08.9055.40 | 138 |
| 05.533001 | 106 | 05.R657002 | 105 | 07.R629002 | 124 | 08.9055.50 | 138 |
| 05.533005 | 106 | 05.R7000 | 111 | 07.R661001 | 123 | 08.9055.60 | 138 |
| 05.533010 | 106 | 05.R700403 | 107 | 07.R661003 | 122 | 08.933.492 | 129 |
| 05.545003 | 101 | 05.R711000 | 107 | 07.R661004 | 121 | 08.R005000 | 138 |
| 05.545004 | 101 | 05.R712000 | 106 | 07.R661005 | 123 | 08.R1280 | 133 |
| 05.545005 | 101 | 05.R714000 | 107 | 07.R920467 | 123 | 08.R1281 | 133 |
| 05.545006 | 102 | 05.R715000 | 106 | 08.004201 | 137 | 08.R3032 | 130 |
| 05.545007 | 110 | 05.R9710 | 102 | 08.005001 | 137 | 08.R3111 | 135 |
| 05.545008 | 110 | 06.4437.00 | 117 | 08.005002 | 137 | 08.R3115 | 135 |
| 05.545009 | 110 | 06.4440.00 | 117 | 08.005003 | 137 | 08.R464002 | 129 |
| 05.545010 | 110 | 06.4502.00 | 117 | 08.005006 | 137 | 08.R464003 | 129 |



| Ref. AIR-FREN | Pág. | Ref. AIR-FREN | Pág. | Ref. AIR-FREN | Pág. | Ref. AIR-FREN | Pág. |
|---------------|------|---------------|------|---------------|------|---------------|------|
| 08.R8015 | 129 | 09.3288.00 | 144 | 09.R051.431 | 148 | 10.1867.10 | 161 |
| 08.R8016 | 130 | 09.334.604 | 155 | 09.R094.660 | 154 | 10.1867.20 | 162 |
| 08.R8020 | 133 | 09.3361.00 | 147 | 09.R1605 | 147 | 10.1867.30 | 162 |
| 08.R8025 | 133 | 09.339.412 | 154 | 09.R1883.60 | 155 | 10.1867.40 | 162 |
| 08.R8030 | 137 | 09.348.735 | 152 | 09.R244.224 | 148 | 10.1867.50 | 161 |
| 08.R8035 | 137 | 09.355.973 | 155 | 09.R244.402 | 148 | 10.1867.60 | 162 |
| 08.R8718 | 138 | 09.358.801 | 153 | 09.R245.752 | 148 | 10.1867.70 | 162 |
| 09.051.102 | 149 | 09.360.717 | 150 | 09.R265.209 | 154 | 10.1867.80 | 162 |
| 09.051.102P | 144 | 09.361.136 | 153 | 09.R291.190 | 154 | 10.1878.25 | 174 |
| 09.051.107 | 149 | 09.371.612 | 150 | 09.R295.040 | 154 | 10.1880.10 | 174 |
| 09.051.107I | 143 | 09.4400.00 | 143 | 09.R295.300 | 152 | 10.1880.20 | 174 |
| 09.051.107P | 143 | 09.446.414 | 153 | 09.R295.530 | 153 | 10.1881.10 | 184 |
| 09.051.111 | 145 | 09.620.462 | 153 | 09.R295.540 | 155 | 10.1881.20 | 184 |
| 09.051.114 | 141 | 09.622.500 | 141 | 09.R295.600 | 155 | 10.1883.20 | 174 |
| 09.051.124 | 149 | 09.622.504 | 151 | 09.R295.820 | 154 | 10.1883.30 | 176 |
| 09.051.126 | 144 | 09.622.508 | 141 | 09.R295.950 | 157 | 10.1883.40 | 175 |
| 09.051.128 | 146 | 09.623.104 | 156 | 09.R3000 | 143 | 10.1883.50 | 175 |
| 09.051.129 | 141 | 09.623.105 | 156 | 09.R3200 | 145 | 10.1883.70 | 175 |
| 09.051.131 | 146 | 09.623.106 | 156 | 09.R3208 | 145 | 10.1883.75 | 175 |
| 09.051.132 | 145 | 09.624.248 | 156 | 09.R3261 | 145 | 10.1883.80 | 175 |
| 09.051.137 | 146 | 09.625.290 | 151 | 09.R3262 | 146 | 10.1883.85 | 175 |
| 09.051.151 | 146 | 09.625.359 | 150 | 09.R3264 | 143 | 10.1883.90 | 174 |
| 09.051.158 | 147 | 09.625.384 | 149 | 09.R334.604 | 155 | 10.1950.10 | 198 |
| 09.051.159 | 147 | 09.625.436 | 144 | 09.R3361 | 147 | 10.2000.31 | 194 |
| 09.051.164 | 147 | 09.626.159 | 156 | 09.R339.412 | 154 | 10.2001.00 | 173 |
| 09.051.176 | 152 | 09.627.612 | 149 | 09.R348.735 | 152 | 10.2132.50 | 173 |
| 09.051.179 | 147 | 09.628.036 | 142 | 09.R355.973 | 155 | 10.2182.37 | 170 |
| 09.051.183 | 152 | 09.628.218 | 153 | 09.R358.801 | 153 | 10.2250.70 | 196 |
| 09.051.205 | 141 | 09.628.258 | 142 | 09.R360.717 | 150 | 10.2286.00 | 189 |
| 09.051.209 | 149 | 09.628.259 | 142 | 09.R371.612 | 149 | 10.2287.50 | 189 |
| 09.051.307 | 145 | 09.628.260 | 142 | 09.R446.414 | 153 | 10.235.030.0 | 198 |
| 09.051.405 | 148 | 09.628.447 | 142 | 09.R4500 | 143 | 10.2400.13 | 198 |
| 09.051.406 | 144 | 09.628.448 | 141 | 09.R620.462 | 153 | 10.2405.55 | 198 |
| 09.051.407 | 148 | 09.628.449 | 142 | 09.R622.500 | 141 | 10.2440.15 | 183 |
| 09.051.412 | 144 | 09.628.492 | 151 | 09.R622.504 | 151 | 10.2440.19 | 181 |
| 09.051.414 | 144 | 09.628.493 | 151 | 09.R622.508 | 141 | 10.2440.20 | 181 |
| 09.051.431 | 148 | 09.628.494 | 151 | 09.R623.104 | 156 | 10.2440.21 | 181 |
| 09.051.438 | 148 | 09.655.435 | 150 | 09.R623.105 | 156 | 10.2440.22 | 181 |
| 09.094.660 | 154 | 09.655.639 | 151 | 09.R623.106 | 156 | 10.2440.23 | 181 |
| 09.1331.770 | 149 | 09.715.607 | 157 | 09.R624.248 | 156 | 10.2440.30 | 181 |
| 09.1337.966 | 150 | 09.715.611 | 152 | 09.R625.290 | 151 | 10.2450.15 | 194 |
| 09.1605.00 | 147 | 09.715.612 | 152 | 09.R625.359 | 150 | 10.2458.48 | 196 |
| 09.1883.60 | 155 | 09.715.613 | 157 | 09.R625.384 | 149 | 10.2550.00 | 196 |
| 09.244.224 | 148 | 09.716.605 | 157 | 09.R626.159 | 156 | 10.2600.00 | 189 |
| 09.244.402 | 148 | 09.725.605 | 146 | 09.R627.612 | 149 | 10.2600.30 | 196 |
| 09.245.752 | 148 | 09.R051.107 | 143 | 09.R628.218 | 153 | 10.2650.10 | 196 |
| 09.265.209 | 154 | 09.R051.111 | 145 | 09.R628.260 | 142 | 10.265653 | 174 |
| 09.291.190 | 154 | 09.R051.114 | 141 | 09.R628.492 | 151 | 10.2670.12 | 197 |
| 09.295.040 | 154 | 09.R051.124 | 149 | 09.R655.435 | 150 | 10.2670.16 | 197 |
| 09.295.300 | 152 | 09.R051.129 | 141 | 09.R655.639 | 151 | 10.2751.75 | 194 |
| 09.295.530 | 153 | 09.R051.131 | 145 | 09.R715.607 | 157 | 10.275653 | 174 |
| 09.295.540 | 155 | 09.R051.132 | 145 | 09.R715.611 | 152 | 10.2765.00 | 194 |
| 09.295.600 | 155 | 09.R051.137 | 146 | 09.R715.612 | 152 | 10.2772.00 | 188 |
| 09.295.820 | 154 | 09.R051.151 | 146 | 09.R715.613 | 157 | 10.2794.00 | 189 |
| 09.295.950 | 157 | 09.R051.158 | 147 | 09.R716.605 | 157 | 10.2819.00 | 189 |
| 09.3000.00 | 143 | 09.R051.164 | 147 | 09.R725.605 | 146 | 10.2823.81 | 189 |
| 09.3100.00 | 143 | 09.R051.176 | 152 | 10.0030.02 | 173 | 10.2844.00 | 189 |
| 09.3200.00 | 145 | 09.R051.179 | 147 | 10.0030.04 | 173 | 10.285654 | 174 |
| 09.3208.00 | 145 | 09.R051.205 | 141 | 10.055527 | 178 | 10.2865.00 | 188 |
| 09.3229.00 | 145 | 09.R051.209 | 149 | 10.100006 | 184 | 10.2876.00 | 194 |
| 09.3261.00 | 145 | 09.R051.307 | 145 | 10.1030.00 | 188 | 10.2882.00 | 188 |
| 09.3262.00 | 146 | 09.R051.406 | 144 | 10.1077.00 | 167 | 10.2882.10 | 188 |
| 09.3264.00 | 143 | 09.R051.407 | 148 | 10.1078.00 | 167 | 10.2950.00 | 182 |
| 09.3269.00 | 143 | 09.R051.414 | 144 | 10.1100.00 | 193 | 10.2950.05 | 182 |

| Ref. AIR-FREN | Pág. | Ref. AIR-FREN | Pág. | Ref. AIR-FREN | Pág. | Ref. AIR-FREN | Pág. |
|---------------|------|---------------|------|---------------|------|---------------|------|
| 10.2950.10 | 182 | 10.410121 | 161 | 10.543112 | 179 | 10.8946.00 | 185 |
| 10.2950.15 | 182 | 10.410127 | 163 | 10.559001 | 176 | 10.9005.10 | 190 |
| 10.2950.20 | 182 | 10.410200 | 168 | 10.559002 | 176 | 10.9005.15 | 190 |
| 10.2950.25 | 182 | 10.410205 | 168 | 10.559003 | 176 | 10.9005.20 | 190 |
| 10.2950.30 | 182 | 10.410210 | 168 | 10.559004 | 176 | 10.9005.25 | 190 |
| 10.2950.35 | 182 | 10.410215 | 168 | 10.559005 | 177 | 10.9005.30 | 190 |
| 10.2950.40 | 182 | 10.410220 | 168 | 10.559006 | 177 | 10.9010.00 | 164 |
| 10.2950.45 | 182 | 10.410225 | 168 | 10.559007 | 177 | 10.9055.00 | 188 |
| 10.2950.50 | 182 | 10.4115.00 | 193 | 10.5676.00 | 184 | 10.9200.00 | 170 |
| 10.2950.55 | 182 | 10.431100 | 164 | 10.5676.10 | 190 | 10.930.930 | 178 |
| 10.2950.60 | 182 | 10.432200 | 164 | 10.5676.20 | 184 | 10.9640.00 | 173 |
| 10.2950.65 | 182 | 10.432407 | 195 | 10.579001 | 191 | 10.975.303 | 195 |
| 10.2950.70 | 182 | 10.432407.1 | 195 | 10.579002 | 191 | 10.975.303.1 | 195 |
| 10.2950.75 | 182 | 10.4375.10 | 183 | 10.579003 | 191 | 10.R1880 | 174 |
| 10.2950.80 | 182 | 10.4395.10 | 182 | 10.579004 | 191 | 10.R1950 | 198 |
| 10.2950.90 | 182 | 10.4395.20 | 182 | 10.579005 | 191 | 10.R1965 | 182 |
| 10.3034.70 | 171 | 10.4410.100 | 186 | 10.579006 | 191 | 10.R2150 | 198 |
| 10.3195.00 | 170 | 10.4410.40 | 186 | 10.579007 | 191 | 10.R2250 | 196 |
| 10.3200.30 | 183 | 10.4420.100 | 186 | 10.579008 | 191 | 10.R2550 | 196 |
| 10.3200.35 | 194 | 10.4420.40 | 186 | 10.579009 | 191 | 10.R2600 | 196 |
| 10.3200.45 | 194 | 10.4494.10 | 187 | 10.579010 | 191 | 10.R2650 | 196 |
| 10.3200.50 | 188 | 10.4494.20 | 187 | 10.579011 | 191 | 10.R3195 | 170 |
| 10.3200.55 | 194 | 10.4510.00 | 193 | 10.579012 | 191 | 10.R3300 | 198 |
| 10.3200.60 | 183 | 10.4510.50 | 193 | 10.579013 | 191 | 10.R3340 | 171 |
| 10.3300.10 | 198 | 10.4535.00 | 166 | 10.579014 | 192 | 10.R3350 | 178 |
| 10.3302.00 | 169 | 10.4578.00 | 166 | 10.579015 | 192 | 10.R3371 | 169 |
| 10.3340.00 | 171 | 10.4587.00 | 166 | 10.579016 | 192 | 10.R3380 | 172 |
| 10.3340.10 | 171 | 10.4593.00 | 166 | 10.579017 | 192 | 10.R3440 | 171 |
| 10.3340.20 | 171 | 10.4600.40 | 169 | 10.579018 | 192 | 10.R3450 | 182 |
| 10.3371.00 | 169 | 10.4720.00 | 172 | 10.579019 | 192 | 10.R3800E | 182 |
| 10.3380.00 | 172 | 10.4730.00 | 172 | 10.579020 | 192 | 10.R3950 | 197 |
| 10.3440.00 | 171 | 10.4740.00 | 172 | 10.579021 | 192 | 10.R4000 | 197 |
| 10.3450.10 | 182 | 10.4750.00 | 173 | 10.579022 | 191 | 10.R4050 | 197 |
| 10.3500.16A | 191 | 10.4750.10 | 173 | 10.579023 | 191 | 10.R410108 | 167 |
| 10.3500.16AP | 191 | 10.484.210 | 195 | 10.6300.00 | 169 | 10.R410109 | 167 |
| 10.3500.16R | 191 | 10.4984.00 | 187 | 10.6300.10 | 169 | 10.R410109.1 | 167 |
| 10.3500.16RP | 191 | 10.500100 | 163 | 10.6700.00 | 170 | 10.R430527 | 178 |
| 10.3500.18A | 191 | 10.500200 | 163 | 10.6710.00 | 165 | 10.R431100 | 164 |
| 10.3500.18R | 191 | 10.5010.00 | 180 | 10.6711.00 | 165 | 10.R4510 | 193 |
| 10.3500.22A | 191 | 10.5018.00 | 185 | 10.6735.00 | 171 | 10.R4600 | 169 |
| 10.3500.22AR | 191 | 10.5018.10 | 185 | 10.6800.00 | 170 | 10.R4720 | 172 |
| 10.3500.22R | 191 | 10.5031.00 | 186 | 10.6900.00 | 170 | 10.R4730 | 172 |
| 10.3500.22RR | 191 | 10.5031.10 | 186 | 10.7010.00 | 197 | 10.R4740 | 172 |
| 10.3640.00 | 186 | 10.5040.00 | 185 | 10.7010.10 | 197 | 10.R5010 | 180 |
| 10.3819.00 | 187 | 10.5040.10 | 185 | 10.7010.40 | 197 | 10.R5210 | 181 |
| 10.410100 | 163 | 10.511000 | 185 | 10.7010.60 | 197 | 10.R5310 | 181 |
| 10.410102 | 161 | 10.5210.10 | 181 | 10.7010.70 | 197 | 10.R5320 | 180 |
| 10.410103 | 161 | 10.5210.60 | 181 | 10.7060.00 | 169 | 10.R5410 | 180 |
| 10.410104 | 161 | 10.5210.80 | 181 | 10.763.775 | 181 | 10.R543012 | 179 |
| 10.410105 | 161 | 10.5310.100 | 180 | 10.772.642 | 174 | 10.R5750 | 197 |
| 10.410106 | 161 | 10.5310.80 | 181 | 10.775.275 | 176 | 10.R611004 | 161 |
| 10.410107 | 163 | 10.5310.90 | 180 | 10.786.653 | 175 | 10.R611005 | 161 |
| 10.410108 | 167 | 10.5410.00 | 180 | 10.8065.00 | 164 | 10.R611006 | 161 |
| 10.410108.1 | 167 | 10.543002 | 178 | 10.8125.00 | 165 | 10.R611007 | 164 |
| 10.410109 | 167 | 10.543012 | 179 | 10.8130.00 | 165 | 10.R611008 | 165 |
| 10.410109.1 | 167 | 10.543022 | 178 | 10.8209.00 | 165 | 10.R611009 | 165 |
| 10.410109.2 | 167 | 10.543032 | 178 | 10.8210.00 | 184 | 10.R611010 | 163 |
| 10.410110 | 161 | 10.543042 | 178 | 10.8219.00 | 165 | 10.R611011 | 161 |
| 10.410111 | 161 | 10.543052 | 179 | 10.8222.00 | 165 | 10.R6300 | 169 |
| 10.410113 | 164 | 10.543062 | 178 | 10.8286.00 | 165 | 10.R6350 | 198 |
| 10.410114 | 161 | 10.543072 | 178 | 10.8299.70 | 187 | 10.R6800 | 170 |
| 10.410115 | 161 | 10.543082 | 178 | 10.8321.00 | 183 | 10.R7050I | 169 |
| 10.410116 | 161 | 10.543092 | 178 | 10.8321.10 | 183 | 10.R7060I | 169 |
| 10.410120 | 161 | 10.543102 | 179 | 10.8400.00 | 177 | 10.R7250 | 196 |



| Ref. AIR-FREN | Pág. | Ref. AIR-FREN | Pág. | Ref. AIR-FREN | Pág. | Ref. AIR-FREN | Pág. |
|---------------|------|---------------|------|---------------|------|---------------|------|
| 10.R8210 | 184 | 11.R65.00 | 211 | 12.380.085 | 233 | 12.R380.020 | 230 |
| 10.R8321 | 183 | 12.350.010 | 215 | 12.380.090 | 234 | 12.R380.030 | 231 |
| 10.R9200 | 170 | 12.350.015 | 215 | 12.380.095 | 234 | 12.R380.035 | 231 |
| 11.R100.00 | 211 | 12.350.020 | 215 | 12.380.100 | 234 | 12.R380.040 | 231 |
| 11.R2750 | 211 | 12.350.025 | 215 | 12.380.105 | 234 | 12.R380.050 | 232 |
| 11.R2901 | 201 | 12.350.030 | 216 | 12.380.110 | 234 | 12.R380.065 | 232 |
| 11.R2902 | 201 | 12.350.035 | 216 | 12.380.115 | 235 | 12.R380.115 | 235 |
| 11.R2903 | 201 | 12.350.040 | 216 | 12.380.120 | 235 | 12.R410.015.1 | 248 |
| 11.R2904 | 201 | 12.350.045 | 216 | 12.380.125 | 235 | 12.R410.015.2 | 248 |
| 11.R2905 | 201 | 12.350.050 | 216 | 12.390.003 | 242 | 12.R410.020.1 | 248 |
| 11.R2906 | 201 | 12.360.010 | 218 | 12.390.024 | 243 | 12.R410.025.1 | 248 |
| 11.R2907 | 202 | 12.360.015 | 218 | 12.390.025 | 243 | 12.R410.030.1 | 249 |
| 11.R2910 | 202 | 12.360.020 | 218 | 12.390.028 | 242 | 12.R410.045.1 | 249 |
| 11.R2911 | 202 | 12.360.025 | 218 | 12.390.031 | 242 | 12.R410.045.2 | 249 |
| 11.R2912 | 202 | 12.360.030 | 218 | 12.390.032 | 242 | 12.R410.055 | 250 |
| 11.R2914 | 202 | 12.360.035 | 219 | 12.390.034 | 243 | 12.R410.060 | 250 |
| 11.R2915 | 203 | 12.360.040 | 219 | 12.390.036 | 241 | 12.R420.010 | 252 |
| 11.R2916 | 203 | 12.360.045 | 219 | 12.390.037 | 241 | 12.R420.015 | 252 |
| 11.R2917 | 203 | 12.360.050 | 219 | 12.390.038 | 241 | 12.R420.035 | 253 |
| 11.R2919 | 203 | 12.360.055 | 219 | 12.390.039 | 241 | 12.R420.040 | 253 |
| 11.R2920 | 203 | 12.360.060 | 220 | 12.391.067 | 243 | 12.R420.055 | 254 |
| 11.R2921 | 204 | 12.360.065 | 220 | 12.391.076 | 242 | 12.R420.080 | 254 |
| 11.R2922 | 204 | 12.360.070 | 219 | 12.391.088 | 241 | 13.228 | 276 |
| 11.R2925 | 204 | 12.360.075 | 219 | 12.391.089 | 242 | 13.229 | 276 |
| 11.R2926 | 204 | 12.360.080 | 220 | 12.391.091 | 241 | 13.230 | 276 |
| 11.R2929 | 204 | 12.360.085 | 219 | 12.391.104 | 242 | 13.234 | 276 |
| 11.R2931 | 205 | 12.360.090 | 220 | 12.400.015 | 244 | 13.235 | 276 |
| 11.R2932 | 205 | 12.360.095 | 220 | 12.400.020 | 244 | 13.372 | 276 |
| 11.R2935 | 205 | 12.360.100 | 220 | 12.400.035 | 244 | 13.37263 | 277 |
| 11.R2936 | 205 | 12.370.010 | 223 | 12.410.010 | 248 | 13.37359 | 277 |
| 11.R2937 | 205 | 12.370.015 | 223 | 12.410.015 | 248 | 13.374 | 276 |
| 11.R2938 | 206 | 12.370.020 | 223 | 12.410.020 | 248 | 13.402 | 276 |
| 11.R2939 | 206 | 12.370.025 | 223 | 12.410.025 | 248 | 13.444 | 276 |
| 11.R2940 | 206 | 12.370.030 | 223 | 12.410.030 | 249 | 13.448 | 276 |
| 11.R2941 | 206 | 12.370.035 | 224 | 12.410.035 | 249 | 13.453 | 276 |
| 11.R2942 | 206 | 12.370.040 | 224 | 12.410.040 | 249 | 13.472 | 276 |
| 11.R2943 | 206 | 12.370.045 | 224 | 12.410.045 | 249 | 13.47369 | 277 |
| 11.R2944 | 207 | 12.370.050 | 224 | 12.410.050 | 250 | 13.476 | 276 |
| 11.R2945 | 207 | 12.370.055 | 224 | 12.410.055 | 250 | 13.53008 | 277 |
| 11.R2946 | 207 | 12.370.060 | 224 | 12.410.060 | 250 | 13.555 | 276 |
| 11.R2950 | 212 | 12.370.065 | 225 | 12.420.010 | 252 | 13.556 | 276 |
| 11.R2951 | 207 | 12.370.070 | 225 | 12.420.015 | 252 | 13.557 | 276 |
| 11.R2952 | 207 | 12.370.075 | 225 | 12.420.020 | 252 | 13.558 | 276 |
| 11.R2953 | 207 | 12.370.080 | 225 | 12.420.025 | 252 | 13.560 | 276 |
| 11.R2956 | 208 | 12.370.085 | 225 | 12.420.030 | 253 | 13.564 | 276 |
| 11.R2957 | 208 | 12.370.090 | 226 | 12.420.035 | 253 | 13.565 | 276 |
| 11.R2958 | 208 | 12.370.095 | 226 | 12.420.040 | 253 | 13.566 | 276 |
| 11.R2960 | 208 | 12.370.100 | 226 | 12.420.045 | 253 | 13.60635 | 271 |
| 11.R2961 | 209 | 12.370.105 | 226 | 12.420.050 | 253 | 13.60706 | 265 |
| 11.R2962 | 209 | 12.380.010 | 230 | 12.420.055 | 254 | 13.60753 | 265 |
| 11.R2963 | 209 | 12.380.015 | 230 | 12.420.060 | 254 | 13.60754 | 265 |
| 11.R2964 | 209 | 12.380.020 | 230 | 12.420.065 | 254 | 13.60771 | 265 |
| 11.R2966 | 210 | 12.380.025 | 230 | 12.420.070 | 254 | 13.60772 | 265 |
| 11.R2967 | 210 | 12.380.030 | 231 | 12.420.075 | 254 | 13.60775 | 265 |
| 11.R2968 | 210 | 12.380.035 | 231 | 12.420.080 | 254 | 13.60920 | 271 |
| 11.R2969 | 210 | 12.380.040 | 231 | 12.R350.015 | 215 | 13.60921 | 271 |
| 11.R2970 | 210 | 12.380.045 | 231 | 12.R350.025 | 215 | 13.60922 | 271 |
| 11.R3150 | 212 | 12.380.050 | 232 | 12.R350.030 | 216 | 13.60923 | 271 |
| 11.R3250 | 211 | 12.380.055 | 232 | 12.R350.035 | 216 | 13.60924 | 271 |
| 11.R3650 | 212 | 12.380.060 | 232 | 12.R350.040 | 216 | 13.60952 | 265 |
| 11.R3700 | 211 | 12.380.065 | 232 | 12.R350.045 | 216 | 13.60953 | 265 |
| 11.R3700E | 211 | 12.380.070 | 233 | 12.R370.010 | 223 | 13.60954 | 265 |
| 11.R3750 | 211 | 12.380.075 | 233 | 12.R370.015 | 223 | 13.60964 | 263 |
| 11.R4150 | 212 | 12.380.080 | 233 | 12.R370.105 | 226 | 13.60965 | 263 |

| Ref. AIR-FREN | Pág. | Ref. AIR-FREN | Pág. | Ref. AIR-FREN | Pág. | Ref. AIR-FREN | Pág. |
|---------------|------|---------------|------|---------------|------|---------------|------|
| 13.62005 | 267 | 13.62609 | 261 | 13.69072 | 271 | 14.5000188 | 289 |
| 13.62006 | 267 | 13.62616 | 265 | 13.69077 | 267 | 14.5000189 | 289 |
| 13.62012 | 263 | 13.62617 | 265 | 13.69078 | 267 | 14.5000417 | 290 |
| 13.62013 | 263 | 13.62620 | 269 | 13.69112 | 276 | 14.5000418 | 290 |
| 13.62038 | 265 | 13.62621 | 269 | 13.69294 | 267 | 14.5000419 | 290 |
| 13.62039 | 265 | 13.62622 | 269 | 13.69295 | 267 | 14.5000421 | 290 |
| 13.62040 | 265 | 13.62624 | 269 | 13.69308 | 267 | 14.5000422 | 290 |
| 13.62041 | 265 | 13.62625 | 269 | 13.69309 | 267 | 14.5000423 | 290 |
| 13.62059 | 265 | 13.62628 | 269 | 13.69331 | 276 | 14.5000424 | 290 |
| 13.62160 | 267 | 13.62629 | 269 | 13.69462 | 273 | 14.5000425 | 290 |
| 13.62161 | 267 | 13.62630 | 269 | 13.69463 | 273 | 14.5000426 | 290 |
| 13.62162 | 267 | 13.62631 | 269 | 13.69677 | 271 | 14.5000427 | 290 |
| 13.62163 | 267 | 13.62654 | 269 | 13.69678 | 271 | 14.5000428 | 290 |
| 13.62173 | 265 | 13.62660 | 269 | 13.69683 | 267 | 14.5001216 | 284 |
| 13.62174 | 265 | 13.62661 | 269 | 13.69684 | 267 | 14.5001616 | 284 |
| 13.62197 | 261 | 13.62672 | 271 | 13.738 | 276 | 14.5001622 | 284 |
| 13.62208 | 263 | 13.62673 | 271 | 13.76906 | 277 | 14.5002216 | 284 |
| 13.62211 | 265 | 13.62676 | 271 | 13.782 | 276 | 14.5002222 | 284 |
| 13.62212 | 265 | 13.62678 | 271 | 13.785 | 276 | 14.5020 | 287 |
| 13.62213 | 265 | 13.62690 | 269 | 13.788 | 276 | 14.5100.20 | 283 |
| 13.62232 | 271 | 13.62691 | 269 | 13.802 | 276 | 14.5405 | 289 |
| 13.62233 | 271 | 13.62704 | 261 | 13.808 | 276 | 14.5865 | 289 |
| 13.62234 | 265 | 13.62705 | 261 | 13.854 | 276 | 14.600.3 | 286 |
| 13.62235 | 265 | 13.62726 | 271 | 13.861 | 276 | 14.6010.10 | 290 |
| 13.62250 | 276 | 13.62729 | 269 | 13.864 | 276 | 14.610.8 | 286 |
| 13.62303 | 263 | 13.62730 | 269 | 13.90000 | 275 | 14.636.7 | 286 |
| 13.62304 | 263 | 13.62738 | 267 | 13.90001 | 275 | 14.7031.00 | 290 |
| 13.62308 | 265 | 13.62739 | 267 | 13.90008 | 275 | 14.712.0 | 286 |
| 13.62318 | 267 | 13.62740 | 267 | 13.90009 | 275 | 14.773.049 | 285 |
| 13.62319 | 267 | 13.62741 | 267 | 13.90010 | 275 | 14.800.0 | 286 |
| 13.62320 | 263 | 13.62782 | 271 | 13.90011 | 275 | 14.8002.10 | 290 |
| 13.62321 | 263 | 13.62783 | 271 | 13.90012 | 275 | 14.8200.20 | 282 |
| 13.62322 | 263 | 13.62786 | 267 | 13.90013 | 275 | 14.900.0 | 286 |
| 13.62408 | 273 | 13.62787 | 267 | 13.90014 | 275 | 14.9042 | 286 |
| 13.62455 | 263 | 13.62788 | 276 | 13.90019 | 275 | 14.9062 | 286 |
| 13.62456 | 263 | 13.62798 | 267 | 13.90020 | 275 | 14.9250.10 | 284 |
| 13.62468 | 269 | 13.62799 | 267 | 13.90021 | 275 | 14.9250.20 | 284 |
| 13.62469 | 269 | 13.62804 | 273 | 13.90022 | 275 | 14.9432 | 287 |
| 13.62478 | 269 | 13.62809 | 265 | 13.90023 | 275 | 14.9590.10 | 284 |
| 13.62508 | 263 | 13.62810 | 265 | 13.90024 | 275 | 14.9590.20 | 284 |
| 13.62509 | 263 | 13.62811 | 265 | 13.90030 | 275 | 14.9590.30 | 284 |
| 13.62523 | 261 | 13.62812 | 265 | 13.90041 | 275 | 14.9590.40 | 284 |
| 13.62524 | 261 | 13.62813 | 267 | 13.992 | 276 | 14.F.37 | 287 |
| 13.62525 | 261 | 13.62814 | 267 | 14.1902 | 290 | 14.I.8C | 287 |
| 13.62526 | 261 | 13.62835 | 267 | 14.21.500 | 285 | 14.I.8L | 287 |
| 13.62532 | 261 | 13.62836 | 267 | 14.2308 | 289 | 14.L.10C | 287 |
| 13.62533 | 261 | 13.62875 | 276 | 14.2371.6 | 286 | 14.L.10L | 287 |
| 13.62535 | 261 | 13.62876 | 276 | 14.2400.20 | 281 | 15.4500.10 | 293 |
| 13.62536 | 261 | 13.62987 | 263 | 14.2545.00 | 288 | 15.4500.11 | 293 |
| 13.62537 | 261 | 13.62988 | 263 | 14.2545.10 | 288 | 15.4500.12 | 293 |
| 13.62538 | 261 | 13.62997 | 267 | 14.2545.20 | 288 | 15.4600.10 | 293 |
| 13.62539 | 261 | 13.62998 | 267 | 14.2545.30 | 288 | 15.4700.10 | 294 |
| 13.62540 | 261 | 13.635 | 276 | 14.2545.40 | 288 | 15.4700.11 | 294 |
| 13.62542 | 261 | 13.66046 | 277 | 14.4315 | 285 | 15.4700.12 | 294 |
| 13.62543 | 261 | 13.682 | 276 | 14.4315.1 | 285 | 15.4800.10 | 294 |
| 13.62544 | 261 | 13.686 | 276 | 14.4315.2 | 285 | 15.5700.10 | 295 |
| 13.62545 | 261 | 13.687 | 276 | 14.4340 | 289 | 15.5800.10 | 295 |
| 13.62546 | 261 | 13.688 | 276 | 14.4710 | 289 | 15.5800.11 | 296 |
| 13.62547 | 261 | 13.69004 | 276 | 14.4715 | 289 | 15.5800.12 | 296 |
| 13.62578 | 263 | 13.69022 | 276 | 14.4855.14 | 286 | 15.5900.10 | 295 |
| 13.62593 | 265 | 13.69024 | 261 | 14.5000160 | 289 | 15.5900.11 | 296 |
| 13.62594 | 265 | 13.69025 | 261 | 14.5000161 | 289 | 15.5900.12 | 296 |
| 13.62596 | 265 | 13.69033 | 269 | 14.5000164 | 289 | 15.7200.10 | 297 |
| 13.62608 | 261 | 13.69034 | 269 | 14.5000178 | 289 | 15.7200.11 | 298 |



| Ref. AIR-FREN | Pág. | Ref. AIR-FREN | Pág. |
|---------------|------|---------------|------|
| 15.7200.12 | 298 | 17.460.080 | 314 |
| 15.7200.13 | 299 | 17.470.010 | 315 |
| 15.7200.14 | 299 | 17.470.015 | 315 |
| 15.7300.10 | 297 | 17.470.020 | 315 |
| 15.7300.11 | 298 | 17.470.025 | 315 |
| 15.7300.12 | 298 | 17.470.030 | 316 |
| 15.7300.13 | 299 | 17.470.035 | 316 |
| 15.7300.14 | 299 | 17.470.040 | 316 |
| 15.7400.10 | 297 | 17.480.010 | 317 |
| 16.6390.00 | 303 | 17.480.015 | 317 |
| 16.6390.10 | 303 | 17.480.020 | 317 |
| 16.6390.20 | 303 | 17.480.025 | 317 |
| 16.6390.30 | 303 | 17.490.010 | 318 |
| 16.6490.00 | 303 | 17.490.015 | 318 |
| 16.6590.00 | 303 | 17.490.020 | 318 |
| 16.6590.10 | 304 | 17.490.025 | 318 |
| 16.6590.20 | 304 | 17.490.030 | 318 |
| 16.6590.30 | 304 | 17.490.035 | 318 |
| 16.6690.00 | 304 | 18.R175.010 | 321 |
| 16.6790.00 | 304 | 18.R175.015 | 321 |
| 16.6890.00 | 304 | 18.R175.020 | 321 |
| 16.6890.10 | 305 | 18.R175.025 | 321 |
| 16.6990.00 | 305 | 18.R175.030 | 321 |
| 16.6990.10 | 305 | 18.R175.035 | 321 |
| 16.6990.20 | 305 | 18.R175.040 | 321 |
| 16.6990.30 | 305 | 18.R175.045 | 321 |
| 16.6990.40 | 305 | 18.R175.050 | 321 |
| 16.7090.00 | 305 | 18.R175.055 | 321 |
| 16.7190.00 | 306 | 18.R175.060 | 321 |
| 16.7190.10 | 306 | 18.R650.005 | 322 |
| 16.7190.20 | 306 | 18.R650.010 | 322 |
| 16.7190.30 | 306 | 18.R650.015 | 322 |
| 16.7190.40 | 306 | 18.R650.020 | 322 |
| 16.7290.00 | 306 | 18.R650.025 | 323 |
| 17.430.010 | 309 | 18.R650.030 | 323 |
| 17.430.015 | 309 | 18.R650.035 | 323 |
| 17.430.020 | 309 | 18.R650.040 | 322 |
| 17.430.025 | 309 | 18.R650.045 | 322 |
| 17.430.030 | 309 | 18.R650.050 | 322 |
| 17.430.035 | 309 | 18.R650.055 | 322 |
| 17.440.010 | 310 | 18.R650.060 | 322 |
| 17.440.015 | 310 | 18.R650.065 | 322 |
| 17.440.020 | 310 | 18.R650.070 | 323 |
| 17.450.010 | 311 | 18.R650.075 | 323 |
| 17.450.015 | 311 | 18.R650.080 | 323 |
| 17.450.020 | 311 | 18.R650.085 | 323 |
| 17.450.025 | 311 | 18.R650.090 | 323 |
| 17.450.030 | 311 | 18.R750.005 | 324 |
| 17.450.035 | 311 | 18.R750.010 | 324 |
| 17.450.040 | 311 | 18.R750.015 | 324 |
| 17.460.010 | 312 | 18.R750.020 | 324 |
| 17.460.015 | 312 | 18.R750.025 | 324 |
| 17.460.020 | 312 | 18.R750.030 | 324 |
| 17.460.025 | 312 | 18.R850.010 | 325 |
| 17.460.030 | 312 | 18.R850.020 | 325 |
| 17.460.035 | 313 | | |
| 17.460.040 | 313 | | |
| 17.460.045 | 313 | | |
| 17.460.050 | 313 | | |
| 17.460.055 | 313 | | |
| 17.460.060 | 314 | | |
| 17.460.065 | 314 | | |
| 17.460.070 | 314 | | |
| 17.460.075 | 314 | | |

CRUCE DE REFERENCIAS: REFERENCIAS ORIGINALES / AIR-FREN

CROSS REFERENCE LIST: ORIGINAL REFERENCES / AIR-FREN

BEDFORD

| Pág. | BEDFORD | AIR-FREN |
|------|----------|------------|
| 173 | 91121409 | 10.0030.02 |
| 147 | 9964739 | 09.1605.00 |

BENDIX

| Pág. | BENDIX | AIR-FREN |
|------|-----------|-------------|
| 179 | 065066 | 10.543102 |
| 179 | 065067 | 10.543112 |
| 109 | 065145 | 05.0651.00 |
| 109 | 065146 | 05.0651.10 |
| 167 | 065224 | 10.410109 |
| 167 | 065225 | 10.410108 |
| 109 | 065437 | 05.0654.00 |
| 110 | 065476 | 05.545011 |
| 109 | 101112 | 05.1011.00 |
| 109 | 101622 | 05.1011.10 |
| 162 | 101900 | 10.1867.60 |
| 110 | 102166 | 05.545008 |
| 110 | 102626 | 05.545008 |
| 110 | 103009 | 05.545007 |
| 110 | 103010 | 05.545010 |
| 110 | 103028 | 05.545009 |
| 188 | 103081 | 10.1030.00 |
| 167 | 107695 | 10.410109.2 |
| 162 | 107794 | 10.1867.40 |
| 162 | 107796 | 10.1867.40 |
| 167 | 107798 | 10.410109.1 |
| 167 | 107799 | 10.1077.00 |
| 167 | 107800 | 10.1078.00 |
| 110 | 109264 | 05.545011 |
| 110 | 109265 | 05.545011 |
| 167 | 109578 | 10.410108 |
| 167 | 109579 | 10.410109 |
| 167 | 109695 | 10.410109.2 |
| 9 | 110007 | 01.1500.10 |
| 13 | 110038 | 01.772.590 |
| 184 | 114004 | 10.5676.00 |
| 102 | 114021 | 05.3300.44 |
| 102 | 114031 | 05.3300.34 |
| ** | 114033 | 03.3050.50 |
| ** | 114039 | 03.3050.00 |
| 82 | 114045 | 03.105508 |
| 81 | 114075 | 03.491102 |
| 181 | 118007 | 10.763.775 |
| 71 | 1186260 | 02.1601L |
| 71 | 1186261 | 02.1802L |
| 67 | 118660501 | 02.2030.00 |
| 48 | 1186731 | 01.1200.140 |
| ** | 1188994 | 10.410112 |
| 47 | 1189106 | 01.1200.125 |
| 143 | 1409786 | 09.3000.00 |
| 181 | 205105 | 10.2440.30 |
| 194 | 227717 | 10.2450.15 |
| 194 | 227788 | 10.2450.15 |
| 194 | 227871 | 10.2450.15 |
| 194 | 228194 | 10.2450.15 |
| 189 | 228600 | 10.2286.00 |
| 189 | 228750 | 10.2287.50 |
| 178 | 229507 | 10.543062 |
| 178 | 229509 | 10.543072 |
| 178 | 229813 | 10.543042 |
| 178 | 229814 | 10.543092 |

| Pág. | BENDIX | AIR-FREN |
|------|----------|--------------|
| 178 | 229859 | 10.543022 |
| 178 | 229860 | 10.543032 |
| 71 | 234100 | 02.1802 |
| 71 | 234101 | 02.1651 |
| 71 | 234189 | 02.1616 |
| 71 | 234226 | 02.1612 |
| 71 | 234433 | 02.1609 |
| 102 | 266784 | 05.R645004 |
| 124 | 267098 | 07.529001 |
| 124 | 272126 | 07.7070.20 |
| 194 | 275175 | 10.2751.75 |
| 124 | 275491 | 07.7070.20 |
| 124 | 275508 | 07.529001 |
| 194 | 276566 | 10.2751.75 |
| 194 | 276567 | 10.2765.00 |
| 190 | 276635 | 10.5676.10 |
| 188 | 277227 | 10.2772.00 |
| 83 | 277863 | 03.527012 |
| 194 | 278614 | 10.3200.35 |
| 189 | 279472 | 10.2794.00 |
| 102 | 280375 | 05.3300.34 |
| 194 | 280479 | 10.3200.55 |
| 184 | 280904 | 10.5676.20 |
| 194 | 281459 | 10.3200.45 |
| 102 | 281672 | 05.7558.00 |
| 102 | 281865 | 05.7558.00 |
| 189 | 281923 | 10.2819.00 |
| 189 | 282381 | 10.2823.81 |
| 189 | 284412 | 10.2844.00 |
| 83 | 286171 | 03.527009 |
| 109 | 286364 | 05.2863.00 |
| 108 | 286370 | 05.545018 |
| 108 | 286371 | 05.545018 |
| 188 | 286500 | 10.2865.00 |
| 83 | 286773 | 03.527014 |
| 83 | 286880 | 03.527010 |
| 108 | 287114 | 05.545019 |
| 83 | 287368 | 03.R527009 |
| 194 | 287417 | 10.2876.00 |
| 194 | 287600 | 10.2876.00 |
| 188 | 288239 | 10.2882.00 |
| 188 | 288241 | 10.2882.10 |
| 179 | 289714 | 10.543052 |
| 65 | 295530 | 02.239.012.1 |
| 65 | 295535 | 02.239.036.1 |
| ** | 3106752 | 197672.00 |
| 61 | 360027 | 01.R197695 |
| 102 | 364013 | 05.R645003 |
| 167 | 5004341 | 10.410108.1 |
| 167 | 5004342 | 10.410109.1 |
| 80 | 65137001 | 03.527001 |
| 80 | 65137003 | 03.527001 |
| 194 | 800372 | 10.2450.15 |
| 121 | AC132A | 07.561007 |
| 121 | AC135AY | 07.561006 |
| 121 | AC135AYZ | 07.561006 |
| 123 | AC135FX | 07.015467 |
| 123 | AC135FX | 07.045522 |
| 123 | AC135G | 07.055522 |
| 121 | AC135G | 07.561007 |
| 103 | AC560BAK | 05.2750.70 |
| 101 | AC570D | 05.135517 |
| 101 | AC570DX | 05.135517 |
| 101 | AC574CXY | 05.135517 |

| Pág. | BENDIX | AIR-FREN |
|------|-----------|--------------|
| 101 | AC586A | 05.575537 |
| 105 | AC595B | 05.557001 |
| ** | ACX83A | ACX83D |
| ** | ACX83B | ACX83D |
| 28 | ACX83D | 01.1200.160 |
| ** | ACX83D | ACX83D |
| 81 | DX80E | 03.527027 |
| ** | DX80E | DX-80E |
| 65 | EF166AAK | 02.239.016.1 |
| 65 | EF206AAK | 02.239.020.1 |
| 65 | EF246AAK | 02.239.024.1 |
| 65 | EF306AAK | 02.239.030.1 |
| 290 | KW37311 | 14.7031.00 |
| 97 | KX11301 | 04.4231.00 |
| 97 | KX11304 | 04.4230.00 |
| 97 | KX20061 | 04.4231.00 |
| 188 | KX2045/16 | 10.2772.00 |
| 101 | KY2308/1 | 05.135517 |
| 33 | KZ4161 | 01.1300.45 |
| 33 | KZ42611 | 01.391.450 |
| 47 | KZ6422 | 01.1200.125 |
| 47 | KZ645/7 | 01.1300.90 |
| 124 | SK26121 | 07.R629002 |
| 33 | SK2681124 | 01.R110061 |
| 115 | VPC40C | 06.539110 |
| 182 | VPC4D | 10.2950.35 |
| 116 | VPS41C | 06.6050.60 |

BERTOCCO

| Pág. | BERTOCCO | AIR-FREN |
|------|----------|-----------|
| 101 | M2310000 | 05.575537 |

BOSCH

| Pág. | BOSCH | AIR-FREN |
|------|------------|--------------|
| 185 | 0265351101 | 10.5018.10 |
| 186 | 0265351201 | 10.5031.10 |
| 178 | 0457102002 | 10.930.930 |
| 10 | 0480033002 | 01.1150.20 |
| ** | 0480072005 | 0480072005 |
| ** | 0480075001 | 0480075001 |
| 16 | 0480099002 | 01.1300.10 |
| 16 | 0480099004 | 01.1300.10 |
| 176 | 0481007009 | 10.559003 |
| 176 | 0481007010 | 10.559002 |
| 184 | 0481007012 | 10.1881.10 |
| 184 | 0481007018 | 10.1881.10 |
| 176 | 0481007020 | 10.559001 |
| 176 | 0481007030 | 10.559002 |
| 176 | 0481007031 | 10.559001 |
| 176 | 0481007036 | 10.559004 |
| 176 | 0481007040 | 10.559001 |
| 184 | 0481007043 | 10.1881.20 |
| 80 | 0481008015 | 03.240.654.0 |
| ** | 0481008020 | 0481008020 |
| 79 | 0481008038 | 03.1900.20 |
| ** | 0481008038 | 0481008038 |
| ** | 0481008041 | 0481008041 |
| ** | 0481008048 | 0481008048 |
| 181 | 0481009019 | 10.5310.80 |
| 180 | 0481009026 | 10.5310.90 |
| 180 | 0481009029 | 10.5310.100 |

| Pág. | BOSCH | AIR-FREN |
|------|------------|------------------------|
| 180 | 0481009039 | 10.5310.100 |
| 180 | 0481009040 | (7,5 BAR) 10.5310.90 |
| 180 | 0481009047 | (7,5 BAR) 10.5310.90 |
| 180 | 0481009064 | 10.5310.100 |
| ** | 0481009501 | 0481009501 |
| ** | 0481009502 | 0481009502 |
| 183 | 0481014001 | 10.2440.15 |
| 183 | 0481014003 | 10.2440.15 |
| 96 | 0481016101 | 04.4224.00 |
| 96 | 0481016103 | 04.4234.00 |
| 96 | 0481016106 | 04.4224.00 |
| ** | 0481016108 | 04.4223.00 |
| 97 | 0481016301 | 04.4225.00 |
| 95 | 0481016303 | 04.4220.00 |
| 95 | 0481016304 | 04.4228.00 |
| 96 | 0481016306 | 04.4222.00 |
| ** | 0481016306 | 0481016306 |
| ** | 0481016309 | 0481016309 |
| 94 | 0481016702 | 04.4215.00 |
| 97 | 0481016703 | 04.4229.00 |
| 183 | 0481017006 | 10.3200.30 |
| 183 | 0481019002 | 10.8321.00 |
| 183 | 0481019004 | 10.4375.10 |
| 185 | 0481019101 | 10.511000 |
| 121 | 0481021017 | 07.561008 |
| 121 | 0481021019 | 07.561008 |
| 121 | 0481021020 | 07.561008 |
| 121 | 0481021022 | 07.561008 |
| 101 | 0481026002 | 05.135517 |
| 101 | 0481026005 | 05.135517 |
| 101 | 0481026006 | 05.135517 |
| 101 | 0481026008 | 05.545003 |
| 102 | 0481026017 | 05.545023 |
| 101 | 0481026019 | 05.545004 |
| 101 | 0481026021 | 05.545004 |
| 101 | 0481026021 | 05.545005 |
| 101 | 0481026022 | 05.545004 |
| 102 | 0481026027 | 05.545006 |
| 102 | 0481026301 | 05.545021 |
| 102 | 0481026302 | 05.545023 |
| 102 | 0481026304 | 05.545022 |
| 182 | 0481027021 | 10.3450.10 |
| 182 | 0481027101 | 10.3450.10 |
| 182 | 0481027105 | 10.3450.10 |
| 106 | 0481036102 | 05.533001 |
| 106 | 0481036105 | 05.533001 |
| ** | 0481036205 | 0481036205 |
| ** | 0481038102 | 0481038102 |
| ** | 0481038118 | 0481038118 |
| ** | 0481039101 | 0481039101 |
| 123 | 0481039101 | 07.015467 |
| 123 | 0481039101 | 07.045522 |
| 123 | 0481039102 | 07.055522 |
| 121 | 0481039102 | 07.561007 |
| 121 | 0481039107 | 07.561007 |
| ** | 0481039110 | 0481039110 |
| 123 | 0481039110 | 07.015467 |
| 123 | 0481039110 | 07.045522 |
| 123 | 0481039118 | 07.065522 |
| 121 | 0481039201 | 07.561001 |
| 121 | 0481039202 | 07.561007 |
| 121 | 0481039209 | 07.561002 |



| Pág. | BOSCH | AIR-FREN |
|------|------------|------------|
| 121 | 0481039211 | 07.561005 |
| 121 | 0481039213 | 07.561009 |
| 121 | 0481039217 | 07.561007 |
| 123 | 0481039218 | 07.065522 |
| 121 | 0481039219 | 07.561006 |
| 121 | 0481039219 | 07.561007 |
| 123 | 0481039221 | 07.015467 |
| 123 | 0481039221 | 07.045522 |
| 121 | 0481039221 | 07.561001 |
| 123 | 0481039222 | 07.055522 |
| 121 | 0481039222 | 07.561007 |
| 121 | 0481039241 | 07.561002 |
| 122 | 0481042201 | 07.7020.70 |
| 122 | 0481042214 | 07.561010 |
| 105 | 0481061005 | 05.557004 |
| 105 | 0481061019 | 05.557001 |
| 105 | 0481061209 | 05.557001 |
| 105 | 0481061214 | 05.557002 |
| 105 | 0481061215 | 05.557001 |
| 105 | 0481061219 | 05.557001 |
| 105 | 0481061225 | 05.557001 |
| 105 | 0481061226 | 05.557001 |
| 105 | 0481061230 | 05.557001 |
| 115 | 0481062005 | 06.539110 |
| ** | 0481062104 | 0481062104 |
| 115 | 0481062104 | 06.559110 |
| 116 | 0481062107 | 06.6050.60 |
| 116 | 0481062112 | 06.569110 |
| 115 | 0481062201 | 06.559120 |
| 116 | 0481062301 | 06.6050.60 |
| 116 | 0481062307 | 06.6050.60 |
| 116 | 0481062401 | 06.6050.60 |
| 182 | 0481063001 | 10.2950.05 |
| 182 | 0481063002 | 10.2950.50 |
| 182 | 0481063005 | 10.2950.10 |
| 182 | 0481063014 | 10.2950.20 |
| 182 | 0481063020 | 10.2950.35 |
| 182 | 0481063021 | 10.2950.90 |
| 182 | 0481063031 | 10.2950.55 |
| 182 | 0481063041 | 10.2950.55 |
| 82 | 0481064001 | 03.3070.10 |
| 80 | 0481064005 | 03.527003 |
| 82 | 0481064007 | 03.3070.10 |
| 81 | 0481064105 | 03.527007 |
| 80 | 0481064108 | 03.527001 |
| 84 | 0481064112 | 03.527016 |
| 81 | 0481064115 | 03.527007 |
| 80 | 0481064201 | 03.527004 |
| 84 | 0481064205 | 03.527023 |
| 85 | 0481064206 | 03.527024 |
| 84 | 0481064212 | 03.527021 |
| 84 | 0481064214 | 03.527022 |
| 80 | 0481064601 | 03.527001 |
| 81 | 0481064603 | 03.527006 |
| 80 | 0481064701 | 03.527005 |
| 79 | 0481232013 | 03.1900.00 |
| 172 | 0481500101 | 10.4740.00 |
| 173 | 0481500101 | 10.4750.00 |
| 172 | 0481500102 | 10.4740.00 |
| ** | 0481503010 | 0481503010 |
| 174 | 0482006006 | 10.1883.20 |
| 175 | 0482006007 | 10.1883.50 |
| 174 | 0482006009 | 10.1883.20 |
| 175 | 0482006011 | 10.1883.50 |

| Pág. | BOSCH | AIR-FREN |
|------|------------|--------------|
| 175 | 0482016003 | 10.1883.70 |
| ** | 0482018002 | 0482018002 |
| 175 | 0482018002 | 10.1883.50 |
| ** | 0482020004 | 0482020004 |
| 173 | 0482020010 | 10.2001.00 |
| ** | 0482022201 | 0482022201 |
| ** | 0482023407 | 0482023407 |
| ** | 0482023505 | 0482023505 |
| ** | 0482024001 | 0482024001 |
| 174 | 0482024001 | 10.1878.25 |
| 70 | 0482510004 | 02.2080.00 |
| 70 | 0482511004 | 02.2070.00 |
| 67 | 0482512001 | 02.1624.00 |
| 67 | 0482512020 | 02.1624.00 |
| 67 | 0482512021 | 02.1624.00 |
| 67 | 0482512022 | 02.1624.00 |
| 67 | 0482512024 | 02.1624.00 |
| 67 | 0482512025 | 02.1624.00 |
| 67 | 0482512202 | 02.2030.00 |
| 67 | 0482512204 | 02.2030.00 |
| 67 | 0482512208 | 02.2030.00 |
| 67 | 0482512212 | 02.2030.00 |
| 67 | 0482512213 | 02.2030.00 |
| 67 | 0482512214 | 02.2030.00 |
| ** | 0482512216 | 0482512216 |
| 69 | 0482515309 | 02.1216.90 |
| 69 | 0482515310 | 02.1216.90 |
| 69 | 0482515406 | 02.1216.90 |
| 69 | 0482515407 | 02.1216.90 |
| 191 | 0484102003 | 10.579006 |
| ** | 0484102016 | 0484102016 |
| 191 | 0484102026 | 10.579005 |
| 191 | 0484103101 | 10.579013 |
| 191 | 0484150111 | 10.579001 |
| 191 | 0484150112 | 10.579002 |
| 195 | 0484210001 | 10.484.210 |
| 195 | 0484210005 | 10.432407 |
| 195 | 0484210008 | 10.432407 |
| 195 | 0484210009 | 10.975.303.1 |
| 195 | 0484210017 | 10.432407 |
| 182 | 0484350001 | 10.4395.10 |
| ** | 0484451007 | 0484451007 |
| 193 | 0484451008 | 10.4510.00 |
| 193 | 0484451013 | 10.4510.50 |
| 161 | 0484460107 | 10.410102 |
| 161 | 0484460116 | 10.410102 |
| 161 | 0484460135 | 10.410115 |
| ** | 0484460147 | 10.410112 |
| 161 | 0484460158 | 10.410110 |
| 161 | 0484460160 | 10.410120 |
| 161 | 0484460194 | 10.410103 |
| ** | 0484460195 | LA-8206 |
| 161 | 0484460197 | 10.410102 |
| ** | 0486204017 | 3E1260010 |
| ** | 0500004104 | 0500004104 |
| 133 | 0500004104 | 08.1295.00 |
| ** | 0500004104 | SV-1295 |
| 133 | 0500004105 | 08.1294.00 |
| ** | 0500004105 | SV-1294 |
| 137 | 0500005001 | 08.005001 |
| 137 | 0500005002 | 08.005002 |
| 137 | 0500005003 | 08.005003 |
| 137 | 0500005006 | 08.005006 |
| ** | 0500005007 | 0500005007 |

| Pág. | BOSCH | AIR-FREN |
|------|------------|------------|
| 137 | 0500005007 | 08.005007 |
| 137 | 0500005011 | 08.005006 |
| 137 | 0500005012 | 08.005007 |
| 137 | 0500005017 | 08.005017 |
| 137 | 0500005018 | 08.005018 |
| 137 | 0500005101 | 08.005101 |
| 137 | 0500005102 | 08.005102 |
| 137 | 0500005104 | 08.005104 |
| 137 | 0500005105 | 08.005105 |
| 184 | 0500100006 | 10.100006 |
| ** | 0504050008 | 0504050008 |
| 287 | 1480284059 | 14.5020 |
| ** | 1480499009 | 1480499009 |
| ** | 1480502017 | 1480502017 |
| ** | 1481290015 | 01.5770 |
| ** | 1481290015 | 1481290015 |
| ** | 1487010034 | 1487010034 |
| ** | 1487010043 | 1487010043 |
| 85 | 1487010060 | 03.R527024 |
| ** | 1487010083 | 1487010083 |
| ** | 1487010094 | 1487010094 |
| 206 | 1487010098 | 11.R2941 |
| ** | 1487010098 | 1487010098 |
| ** | 1487010113 | 1487010113 |
| ** | 1487010115 | 1487010115 |
| ** | 1487010117 | 1487010117 |
| ** | 1487010119 | 1487010119 |
| ** | 1487010124 | 1487010124 |
| ** | 1487010134 | 1487010134 |
| 205 | 1487010139 | 11.R2935 |
| ** | 1487010149 | 1487010149 |
| ** | 1487010158 | 1487010158 |
| ** | 1487010160 | 1487010160 |
| 201 | 1487010165 | 11.R2905 |
| ** | 1487010170 | 1487010170 |
| 201 | 1487010178 | 11.R2906 |
| 193 | 1487010199 | 10.R4510 |
| ** | 1487010203 | 1487010203 |
| ** | 1487010210 | 1487010210 |
| ** | 1487010212 | 1487010212 |
| 205 | 1487010218 | 11.R2936 |
| 206 | 1487010219 | 11.R2943 |
| 180 | 1487010221 | 10.R5320 |
| 202 | 1487010234 | 11.R2914 |
| ** | 1487010234 | 1487010234 |
| 203 | 1487010237 | 11.R2915 |
| ** | 1487010260 | 1487010260 |
| ** | 1487010265 | 1487010265 |
| ** | 1487010281 | 1487010281 |
| ** | 1487010286 | 1487010286 |
| ** | 1487010301 | 1487010301 |
| 81 | 1487010338 | 03.R527007 |
| 82 | 1487020009 | 03.3070.20 |
| 290 | 1487419003 | 14.7031.00 |
| 161 | 1487434901 | 10.1867.10 |
| ** | 1488705068 | 1488705068 |
| ** | 1488705077 | 1488705077 |
| 137 | 1507010007 | 08.R8030 |
| 137 | 1507010010 | 08.R8035 |
| 137 | 1507413041 | 08.413043 |
| 137 | 1507413042 | 08.413042 |
| 137 | 1507413043 | 08.413043 |
| 161 | 1987434016 | 10.1867.10 |
| 172 | 3340524012 | 10.R4740 |

| BPW | | |
|------|----------------|--------------|
| Pág. | BPW | AIR-FREN |
| 107 | 02.033.20.90.0 | 05.714000 |
| 107 | 02.0332.13.00 | 05.714000 |
| 177 | 02.431.14.10.0 | 10.8400.00 |
| 177 | 02.4311.41.00 | 10.8400.00 |
| 303 | 02.5664.57.00 | 16.6390.20 |
| 182 | 0201190100 | 10.4395.10 |
| 65 | 0203272800 | 02.239.036.1 |
| 69 | 0203275600 | 02.2024.60 |
| 69 | 0203276600 | 02.2024.60 |
| 69 | 0203276700 | 02.2024.60 |
| 66 | 0203277500 | 02.239.020.6 |
| 69 | 020327880 | 02.1624.60 |
| 69 | 0203278900 | 02.1624.60 |
| 107 | 0203320900 | 05.700000 |
| 107 | 0203320900 | 05.700000 |
| 191 | 0218240300 | 10.579001 |
| 71 | 0222030100 | 02.1609 |
| 71 | 0222030400 | 02.1651L |
| 71 | 0222030400 | 02.1802L |
| 71 | 0222030500 | 02.1651L |
| 186 | 0233170700 | 10.4420.40 |
| 129 | 0243100500 | 08.933.492 |
| 183 | 0243100900 | 10.3200.30 |
| 182 | 0243102000 | 10.2950.35 |
| 182 | 0243102900 | 10.4395.10 |
| 173 | 0243103900 | 10.9640.00 |
| 178 | 0243107200 | 10.543002 |
| 181 | 0243108000 | 10.5210.10 |
| 130 | 0243109020 | 08.8010.40 |
| 130 | 0243112800 | 08.3032.00 |
| 135 | 0243112800 | 08.3111.00 |
| 184 | 0243112800 | 10.1881.10 |
| 130 | 0243113500 | 08.8010.50 |
| 182 | 0243114400 | 10.2950.15 |
| 179 | 0243115000 | 10.543012 |
| 108 | 0243115100 | 05.557006 |
| 285 | 0252192210 | 14.21.500 |
| 303 | 0256642657 | 16.6390.00 |
| 303 | 0256644657 | 16.6390.10 |
| 303 | 0256645800 | 16.6390.30 |
| 276 | 0517482122 | 13.62876 |
| 276 | 0517482142 | 13.62876 |
| 276 | 0517482212 | 13.62875 |
| 276 | 0517482222 | 13.62875 |
| 276 | 0517482242 | 13.62876 |
| 276 | 0517482312 | 13.62876 |
| 276 | 0517482472 | 13.62876 |
| 276 | 0517482632 | 13.62875 |
| 276 | 0517483030 | 13.62875 |
| 66 | 0544410370 | 02.239.036.2 |
| 65 | 0544416010 | 02.239.024.1 |
| 68 | 0544421010 | 02.3030.80 |
| 68 | 0544421040 | 02.3030.80 |
| 68 | 0544421110 | 02.3030.80 |
| 69 | 0544440010 | 02.1624.50 |
| 69 | 0544440020 | 02.1624.50 |
| 69 | 0544441040 | 02.1616.60 |
| 130 | 1030920618 | 08.8010.40 |
| 323 | 980102600 | 18.R650.070 |
| 322 | 980102630 | 18.R650.005 |
| 323 | 980102970 | 18.R650.080 |

CRUCE DE REFERENCIAS: REFERENCIAS ORIGINALES / AIR FREN

CROSS REFERENCE LIST: ORIGINAL REFERENCES / AIR FREN

CLAYTON DEWANDRE

| Pág. | CLAYTON DEWANDRE | AIR-FREN |
|------|------------------|------------|
| 147 | APGA1605P | 09.1605.00 |
| 147 | GA29317 | 09.R1605 |

DAF

| Pág. | DAF | AIR-FREN |
|------|---------|--------------|
| 191 | 003162 | 10.579013 |
| 209 | 0066089 | 11.R2961 |
| 209 | 0066093 | 11.R2962 |
| 141 | 0066873 | 09.R051.129 |
| 129 | 0067595 | 08.R464002 |
| 105 | 0068797 | 05.R008000 |
| 101 | 0069857 | 05.575537 |
| 121 | 0075038 | 07.561002 |
| 182 | 0110442 | 10.2950.35 |
| 103 | 0164464 | 05.605733 |
| 93 | 0170456 | 04.4212.00 |
| 107 | 0170985 | 05.6120.40 |
| 93 | 0176628 | 04.4211.10 |
| 123 | 0178241 | 07.R661005 |
| 173 | 0262633 | 10.0030.04 |
| 175 | 0266275 | 10.1883.40 |
| 16 | 0269929 | 01.1200.25 |
| 141 | 0281009 | 09.051.129 |
| 93 | 0281780 | 04.4213.00 |
| 65 | 0284503 | 02.239.020.1 |
| 195 | 0286951 | 10.432407 |
| 71 | 0305049 | 02.1651 |
| 93 | 0371274 | 04.4213.00 |
| 97 | 0374642 | 04.4225.00 |
| 107 | 0480579 | 05.700000 |
| 82 | 0503366 | 03.105508 |
| 215 | 0506109 | 12.350.025 |
| 105 | 0511739 | 05.R657000 |
| 121 | 0513733 | 07.561007 |
| 94 | 0513798 | 04.R4214 |
| 93 | 0513799 | 04.R4213 |
| 22 | 0513821 | 01.1300.115 |
| 215 | 0517097 | 12.350.025 |
| 71 | 0533891 | 02.1651 |
| 21 | 0537746 | 01.1200.45 |
| 123 | 0540349 | 07.561003 |
| 94 | 0559817 | 04.4214.00 |
| 183 | 0566360 | 10.3200.60 |
| 178 | 0587805 | 10.930.930 |
| 215 | 0624147 | 12.350.020 |
| 173 | 0629166 | 10.4750.00 |
| 183 | 0635474 | 10.3200.60 |
| 129 | 0638057 | 08.933.492 |
| 182 | 0639990 | 10.2950.15 |
| 177 | 0642909 | 10.559006 |
| 173 | 0643603 | 10.0030.02 |
| 93 | 0644516 | 04.4211.00 |
| 137 | 0644521 | 08.005006 |
| 177 | 0649246 | 10.559006 |
| 121 | 0658098 | 07.561005 |
| 149 | 0658882 | 09.051.102 |
| 141 | 0659807 | 09.051.114 |
| 20 | 066043 | 01.1300.40 |
| 173 | 0668030 | 10.9640.00 |

| Pág. | DAF | AIR-FREN |
|------|---------|---------------|
| 216 | 0680156 | 12.350.030 |
| 215 | 0680217 | 12.350.015 |
| 216 | 0681653 | 12.350.035 |
| 216 | 0682258 | 12.350.035 |
| 215 | 0682260 | 12.350.025 |
| 216 | 0682262 | 12.350.030 |
| 215 | 0682263 | 12.350.015 |
| 215 | 0682264 | 12.350.020 |
| 216 | 0682958 | 12.350.050 |
| 216 | 0682968 | 12.350.035 |
| 216 | 0683579 | 12.350.045 |
| 216 | 0683586 | 12.350.045 |
| 122 | 0689319 | 07.7020.70 |
| 71 | 0689366 | 02.1601L |
| 122 | 0689405 | 07.R661003 |
| 107 | 0689509 | 05.R711000 |
| 71 | 0689511 | 02.1616L |
| 106 | 0691051 | 05.R633001 |
| 84 | 0691640 | 03.527018 |
| 71 | 0691763 | 02.1802L |
| 90 | 0691984 | 04.R631009 |
| 93 | 0692284 | 04.R631003 |
| 105 | 0692465 | 05.R657002 |
| ** | 0693487 | 10.R3200E |
| 71 | 0694277 | 02.1651L |
| 204 | 0694417 | 11.R2921 |
| 203 | 0694429 | 11.R2920 |
| 93 | 0695880 | 04.R4212 |
| 96 | 0696221 | 04.R631008 |
| ** | 0696364 | 11.R2928 |
| 80 | 0697422 | 03.R627001 |
| 121 | 0698276 | 07.R661004 |
| 141 | 0698529 | 09.R051.114 |
| 161 | 0699387 | 10.1867.10 |
| 71 | 0706123 | 02.1802 |
| 71 | 0706128 | 02.1651 |
| 288 | 0709573 | 14.2545.00 |
| 290 | 0709671 | 14.7031.00 |
| 108 | 0719765 | 05.557005 |
| 108 | 0720509 | 05.R557005 |
| 71 | 0721172 | 02.1636L |
| 183 | 0736602 | 10.8321.00 |
| 107 | 0738068 | 05.6120.50 |
| 261 | 0740321 | 13.62608 |
| 261 | 0740322 | 13.62609 |
| 181 | 0745062 | 10.5210.10 |
| 132 | 0759050 | 08.8010.80 |
| 101 | 0802144 | 05.R645002 |
| 181 | 0812372 | 10.R5210 |
| 103 | 0830550 | 05.235546 |
| 185 | 0890743 | 10.5018.10 |
| 67 | 0892757 | 02.3030.00 |
| 154 | 094660 | 09.094.660 |
| 121 | 100587 | 07.561005 |
| 121 | 105101 | 07.561008 |
| 182 | 108756 | 10.4395.10 |
| 182 | 109391 | 10.2950.45 |
| 178 | 112039 | 10.055527 |
| 309 | 113365 | 17.430.015 |
| 84 | 1142040 | 03.527018 |
| 314 | 1142188 | 17.460.060 |
| 92 | 116487 | 04.240.726.26 |
| 92 | 116487 | 04.240.726.31 |
| 178 | 1191376 | 10.R3350 |

| Pág. | DAF | AIR-FREN |
|------|----------|---------------|
| 195 | 1193201 | 10.432407 |
| 137 | 1211972 | 08.005007 |
| 137 | 1211973 | 08.005006 |
| 154 | 1237505 | 09.R094.660 |
| ** | 1238505 | AE-4437 |
| 24 | 1241874 | 01.1200.85 |
| 154 | 1242089 | 09.265.209 |
| 141 | 1242616 | 09.622.500 |
| 23 | 1243571 | 01.1200.55 |
| 131 | 1247631 | 08.4410.70 |
| 309 | 1250710 | 17.430.035 |
| 23 | 1253530 | 01.1300.85 |
| 71 | 1257928 | 02.1609 |
| 105 | 1259855 | 05.009300 |
| 101 | 1259856 | 05.545017 |
| 311 | 1261652 | 17.450.015 |
| 154 | 1265209 | 09.265.209 |
| 309 | 1267988 | 17.430.010 |
| 242 | 1270247 | 12.391.089 |
| 67 | 1270272 | 02.2730.00 |
| 67 | 1270272A | 02.2730.00 |
| 25 | 1274407 | 01.1200.130 |
| 261 | 1282111 | 13.69024 |
| 261 | 1282112 | 13.69025 |
| 24 | 1283815 | 01.1300.110 |
| 24 | 1283817 | 01.391.1200 |
| 161 | 1285548 | 10.410103 |
| ** | 1285548 | LA-8206 |
| 309 | 1287806 | 17.430.025 |
| 141 | 1287876 | 09.622.508 |
| 154 | 1291190 | 09.291.190 |
| 130 | 1291360 | 08.3032.00 |
| 135 | 1291360 | 08.3111.00 |
| 141 | 1291857 | 09.R622.500 |
| 191 | 1294457 | 10.3500.16A |
| 191 | 1294458 | 10.3500.16R |
| 25 | 1298052 | 01.1200.130 |
| 309 | 1303821 | 17.430.030 |
| 171 | 1303948 | 10.3340.20 |
| 309 | 1303975 | 17.430.035 |
| 209 | 1304182 | 11.R2963 |
| 180 | 1305138 | 10.5010.00 |
| 131 | 1305844 | 08.4410.50 |
| 309 | 1310137 | 17.430.010 |
| 26 | 1310523 | 01.1200.170 |
| ** | 1314296 | SV-1303 |
| 161 | 1314779 | 10.410103 |
| 154 | 1316359 | 09.R265.209 |
| 24 | 1321470 | 01.1200.85 |
| 91 | 1325088 | 04.240.726.21 |
| 186 | 1325323 | 10.5031.10 |
| 106 | 1325324 | 05.712000 |
| 107 | 1325325 | 05.714000 |
| 104 | 1325328 | 05.2458.51 |
| 103 | 1325329 | 05.2458.49 |
| 104 | 1325331 | 05.2458.50 |
| 102 | 1325335 | 05.9710.00 |
| 130 | 1325336 | 08.8010.50 |
| 130 | 1325337 | 08.8010.40 |
| 192 | 1325340 | 10.579015 |
| 192 | 1325341 | 10.579014 |
| 71 | 1325345 | 02.1601 |
| 71 | 1325346 | 02.1616 |
| 71 | 1325347 | 02.1612 |

| Pág. | DAF | AIR-FREN |
|------|---------|-------------|
| 68 | 1325351 | 02.3030.80 |
| 141 | 1327940 | 09.622.508 |
| 314 | 1328793 | 17.460.075 |
| 141 | 1330770 | 09.622.508 |
| 175 | 1331309 | 10.1883.80 |
| 309 | 1334350 | 17.430.025 |
| 188 | 1336514 | 10.3200.50 |
| 85 | 1337184 | 03.527019 |
| 105 | 1337535 | 05.R009300 |
| 154 | 1339412 | 09.339.412 |
| 101 | 1343946 | 05.R5020 |
| 209 | 1344111 | 11.R2964 |
| 141 | 1346863 | 09.622.508 |
| 141 | 1346864 | 09.622.508 |
| 141 | 1346865 | 09.622.500 |
| 141 | 1346866 | 09.622.500 |
| 180 | 1347695 | 10.R5010 |
| 154 | 1348734 | 09.265.209 |
| 152 | 1348735 | 09.348.735 |
| 141 | 1348878 | 09.R622.508 |
| 141 | 1349064 | 09.R622.500 |
| 142 | 1349889 | 09.628.447 |
| 161 | 1351443 | 10.410103 |
| 85 | 1353582 | 03.527019 |
| 154 | 1354518 | 09.R291.190 |
| 309 | 1362752 | 17.430.035 |
| 22 | 1373080 | 01.1200.50 |
| 154 | 1373531 | 09.R339.412 |
| 152 | 1373532 | 09.R348.735 |
| 154 | 1373533 | 09.R265.209 |
| 171 | 1379772 | 10.3340.20 |
| 171 | 1379776 | 10.3340.10 |
| 175 | 1389428 | 10.1883.80 |
| 161 | 1391510 | 10.1867.50 |
| 141 | 1392204 | 09.628.448 |
| 142 | 1392205 | 09.628.449 |
| 152 | 1395485 | 09.348.735 |
| 147 | 13H6616 | 09.1605.00 |
| 142 | 1438606 | 09.628.036 |
| ** | 1443153 | ZB-4578 |
| 141 | 1443521 | 09.622.500 |
| 142 | 1443522 | 09.628.259 |
| 142 | 1443523 | 09.628.258 |
| 142 | 1443524 | 09.628.260 |
| 142 | 1443527 | 09.R628.260 |
| 142 | 1443529 | 09.628.449 |
| 141 | 1443530 | 09.622.508 |
| 141 | 1443531 | 09.622.508 |
| 142 | 1443533 | 09.628.447 |
| 323 | 1448914 | 18.R650.070 |
| 141 | 1450047 | 09.628.448 |
| 171 | 1457275 | 10.3340.20 |
| 171 | 1457276 | 10.3340.10 |
| 81 | 1504971 | 03.527006 |
| ** | 1505034 | 10.410112 |
| 131 | 1505053 | 08.4410.60 |
| 177 | 1505078 | 10.559005 |
| 163 | 1505119 | 10.410107 |
| 144 | 1505141 | 09.051.406 |
| 102 | 1505150 | 05.545021 |
| 186 | 1505211 | 10.4420.100 |
| 102 | 1505412 | 05.545023 |
| 186 | 1506005 | 10.4410.40 |
| 186 | 1506006 | 10.4410.100 |



| Pág. DAF | AIR-FREN |
|----------|-----------------------|
| 82 | 1506081 03.105510 |
| 84 | 1506092 03.527023 |
| 184 | 1506104 10.1881.20 |
| 173 | 1506146 10.2001.00 |
| 180 | 1506190 10.5410.00 |
| 180 | 1506193 10.5010.00 |
| 107 | 1506198 05.R700403 |
| ** | 1506198 11.R2959 |
| 106 | 1506217 05.533010 |
| 163 | 1506409 10.410107 |
| 163 | 1506410 10.410107 |
| 91 | 1506443 04.240.726.21 |
| 152 | 1506460 09.051.183 |
| 162 | 1506635 10.1867.70 |
| 80 | 1506783 03.527001 |
| 84 | 1517913 03.527017 |
| 164 | 1517979 10.431100 |
| 187 | 1518041 10.4494.10 |
| 187 | 1518043 10.4494.20 |
| 80 | 1518060 03.527003 |
| 84 | 1518064 03.527016 |
| 85 | 1518065 03.527025 |
| 80 | 1518067 03.527004 |
| 84 | 1518069 03.527022 |
| 84 | 1518070 03.527021 |
| 81 | 1518073 03.491102 |
| 177 | 1518085 10.559007 |
| 169 | 1518090 10.6300.00 |
| 82 | 1518099 03.3070.10 |
| 106 | 1518122 05.533005 |
| 163 | 1518168 10.410107 |
| 192 | 1518206 10.579017 |
| 192 | 1518207 10.579016 |
| 192 | 1518208 10.579020 |
| 192 | 1518209 10.579019 |
| 192 | 1518210 10.579018 |
| 192 | 1518211 10.579021 |
| 95 | 1518221 04.4220.00 |
| 144 | 1518255 09.051.414 |
| 104 | 1518257 05.557007 |
| 102 | 1518267 05.545022 |
| 82 | 1518770 03.105509 |
| 163 | 1519201 10.R611010 |
| 91 | 1519242 04.240.726.24 |
| 141 | 1519281 09.051.205 |
| ** | 1519292 09.R051.405 |
| 207 | 1519292 11.R2946 |
| 94 | 1524310 04.4239.00 |
| 261 | 159556 13.62523 |
| 261 | 159557 13.62524 |
| 261 | 159558 13.62525 |
| 261 | 159559 13.62526 |
| 261 | 159560 13.62540 |
| 261 | 159561 13.62542 |
| 261 | 159562 13.62543 |
| 261 | 159563 13.62544 |
| 261 | 159564 13.62545 |
| 261 | 159565 13.62535 |
| 261 | 159569 13.62546 |
| 261 | 159576 13.62547 |
| 261 | 159587 13.62536 |
| 261 | 159588 13.62537 |
| 261 | 159589 13.62538 |
| 261 | 159590 13.62539 |

| Pág. DAF | AIR-FREN |
|----------|---------------------|
| 67 | 1603234 02.2730.00 |
| 216 | 1609871 12.350.045 |
| 310 | 1615927 17.440.010 |
| 185 | 1624254 10.5040.00 |
| 310 | 1634627 17.440.010 |
| 309 | 1664346 17.430.035 |
| 93 | 176628 04.4211.10 |
| 309 | 1780332 17.430.035 |
| ** | 223432 SV-1329 |
| ** | 223433 SV-1330 |
| 154 | 223443 09.094.660 |
| 184 | 225858 10.8210.00 |
| 184 | 228858 10.8210.00 |
| 149 | 262077 09.051.102 |
| 173 | 262633 10.0030.04 |
| 311 | 266060 17.450.015 |
| 93 | 271274 04.4213.00 |
| 261 | 278350 13.62523 |
| 261 | 278351 13.62524 |
| 309 | 279810 17.430.010 |
| 261 | 281090 13.62525 |
| 261 | 281091 13.62526 |
| 261 | 282609 13.62197 |
| 261 | 284860 13.62535 |
| 18 | 285596 01.1200.30 |
| ** | 285596 CD 419 |
| 19 | 285597 01.1200.35 |
| 141 | 286295 09.051.129 |
| ** | 287624 SV-1330 |
| ** | 287625 SV-1329 |
| 261 | 289691 13.62536 |
| 261 | 289692 13.62537 |
| 261 | 292924 13.62532 |
| 261 | 292925 13.62533 |
| 261 | 297172 13.62545 |
| 261 | 297173 13.62544 |
| 121 | 302239 07.561008 |
| 80 | 309505 03.240.654.0 |
| 155 | 334604 09.334.604 |
| 108 | 359485 05.557005 |
| 261 | 361323 13.62540 |
| 261 | 361541 13.62542 |
| 261 | 361542 13.62543 |
| 261 | 361543 13.62539 |
| 261 | 361544 13.62538 |
| 93 | 371274 04.4213.00 |
| 97 | 374642 04.4225.00 |
| 261 | 374800 13.62547 |
| 141 | 377009 09.622.500 |
| 82 | 503366 03.105508 |
| 178 | 512823 10.R430527 |
| 93 | 513799 04.R4213 |
| 22 | 513821 01.1300.115 |
| 22 | 513823 01.391.800 |
| 309 | 514454 17.430.010 |
| 22 | 528737 01.1200.50 |
| 261 | 537538 13.62197 |
| 20 | 537745 01.1200.40 |
| 21 | 537746 01.1200.45 |
| 20 | 555097 01.1200.40 |
| 21 | 555098 01.1200.45 |
| 94 | 559817 04.4214.00 |
| 183 | 566360 10.3200.60 |
| 96 | 621381 04.4234.00 |

| Pág. DAF | AIR-FREN |
|----------|---------------------|
| 149 | 624993 09.051.102 |
| 163 | 629166 10.410100 |
| 173 | 629166 10.4750.00 |
| 191 | 632565 10.579005 |
| 191 | 632566 10.579006 |
| 183 | 635474 10.3200.60 |
| 184 | 637210 10.1881.10 |
| 177 | 642909 10.559006 |
| 173 | 643603 10.0030.02 |
| 19 | 644264 01.1200.35 |
| 137 | 644521 08.005006 |
| 67 | 646833 02.3630.00 |
| 67 | 646834 02.3630.00 |
| 65 | 656045 02.239.030.1 |
| 185 | 657227 10.5018.10 |
| 309 | 658418 17.430.020 |
| 309 | 658428 17.430.020 |
| 149 | 658882 09.051.102 |
| 309 | 659320 17.430.010 |
| 141 | 659807 09.051.114 |
| 144 | 659807 09.051.126 |
| 209 | 66089 11.R2961 |
| 202 | 665062 11.R2907 |
| ** | 665112 05.711.000 |
| 133 | 667225 08.1295.00 |
| ** | 667225 SV-1295 |
| 19 | 667441 01.1200.35 |
| 173 | 668030 10.9640.00 |
| 115 | 670766 06.559120 |
| 116 | 670766 06.6050.60 |
| ** | 677965 SV-1280 |
| 216 | 682958 12.350.050 |
| 216 | 682980 12.350.040 |
| 216 | 683225 12.350.045 |
| 202 | 689275 11.R2910 |
| 122 | 689405 07.R661003 |
| 84 | 691640 03.527018 |
| 90 | 691984 04.R631009 |
| 18 | 692001 01.1300.25 |
| 19 | 692002 01.1300.35 |
| 169 | 692183 10.7060.00 |
| 137 | 692491 08.413042 |
| 137 | 692492 08.413043 |
| ** | 693487 10.R3200E |
| 96 | 696221 04.R631008 |
| 173 | 696514 10.9640.00 |
| 193 | 698809 10.R4510 |
| 205 | 699388 11.R2935 |
| ** | 699525 SV-1303 |
| 205 | 699904 11.R2936 |
| 288 | 709061 14.2545.00 |
| 71 | 709116 02.1609 |
| 288 | 709573 14.2545.00 |
| 108 | 719765 05.557005 |
| 108 | 720509 05.R557005 |
| 175 | 735121 10.1883.50 |
| 261 | 755616 13.62704 |
| 261 | 755617 13.62705 |
| 132 | 759050 08.8010.80 |
| 22 | 762788 01.1200.50 |
| 181 | 812372 10.R5210 |
| ** | 815444 10.R3200E |
| 183 | 816874 10.R8321 |
| 67 | 835107 02.3630.00 |

| Pág. DAF | AIR-FREN |
|----------|----------------------|
| 177 | 867872 10.8400.00 |
| ** | 88640110 370080360 |
| 185 | 890743 10.5018.10 |
| 154 | 894880 09.094.660 |
| 261 | 92419 13.62532 |
| 261 | 92420 13.62533 |
| 107 | ACU 9340 05.714000 |
| 107 | ACU9340 05.714000 |
| 107 | ACU9430 05.714000 |
| 311 | ATRB247 17.450.015 |
| 215 | CBU2148 12.350.010 |
| 215 | CBU2396 12.350.010 |
| 173 | FBU3124 10.9640.00 |
| 147 | FBU3957 09.R1605 |
| 94 | FBU4563 04.R4214 |
| 122 | FBU4800 07.R661003 |
| 107 | FBU5577 05.R714000 |
| 94 | FBU8602 04.R4214 |
| 209 | FBU9491 11.R2961 |
| 107 | FBU9640 05.R714000 |
| ** | KS93052600 370080340 |

DENNIS

| Pág. DENNIS | AIR-FREN |
|-------------|---------------------|
| 141 | 651189 09.051.114 |
| 311 | 651332 17.450.030 |
| 309 | 651390 17.430.015 |
| 185 | 6538771 10.5018.00 |
| 185 | 6538771 10.5018.10 |
| 186 | 654195-2 10.4410.40 |
| 107 | 654731 05.714000 |
| 107 | 654731-1 05.R714000 |
| 185 | 6556402 10.8946.00 |
| 130 | 655687 08.8010.40 |
| 310 | 6573102 17.440.010 |
| 185 | 6576932 10.5018.00 |

DEUTZ

| Pág. DEUTZ | AIR-FREN |
|------------|--------------------------|
| 309 | 01172721 17.430.015 |
| 16 | 01173720 01.1200.25 |
| 17 | 01173860 01.1200.20 |
| 27 | 01174473 01.1200.135 |
| 309 | 01261558 17.430.020 |
| 183 | 01263151 10.8321.00 |
| 309 | 02922101 17.430.030 |
| 181 | 04347830 10.5310.80 |
| 132 | 04432191 08.8010.80 |
| 309 | 06276678 17.430.010 |
| 309 | 1212330062000 17.430.010 |
| 309 | 1212330062001 17.430.010 |

DOLZ

| Pág. DOLZ | AIR-FREN |
|-----------|-----------------|
| 218 | B114 12.360.010 |
| 244 | B116 12.400.020 |
| 244 | B181 12.400.015 |
| 244 | B182 12.400.035 |

| Pág. DOLZ | AIR-FREN |
|-----------|------------|
| ** B183 | 12.400.010 |
| 248 E110 | 12.410.020 |
| 248 E111 | 12.410.015 |
| 248 E112 | 12.410.010 |
| 250 E113 | 12.410.050 |
| 250 E114 | 12.410.055 |
| 250 E115 | 12.410.060 |
| 219 I119 | 12.360.070 |
| 219 I120 | 12.360.050 |
| 220 I121 | 12.360.090 |
| 219 I123 | 12.360.035 |
| 219 I124 | 12.360.085 |
| 218 I126 | 12.360.025 |
| 220 I127 | 12.360.065 |
| 220 I131 | 12.360.060 |
| 219 I134 | 12.360.045 |
| 218 I140 | 12.360.030 |
| 220 I163 | 12.360.080 |
| 219 I168 | 12.360.055 |
| 219 I169 | 12.360.075 |
| 219 I264 | 12.360.040 |
| 215 L214 | 12.350.010 |
| 232 M078 | 12.380.050 |
| 223 M178 | 12.370.030 |
| 231 M178 | 12.380.045 |
| 224 M278 | 12.370.035 |
| 231 M610 | 12.380.035 |
| 230 M611 | 12.380.015 |
| 230 M612 | 12.380.020 |
| 230 M613 | 12.380.010 |
| 230 M614 | 12.380.025 |
| 223 M617 | 12.370.025 |
| 225 M618 | 12.370.080 |
| 225 M619 | 12.370.075 |
| 233 M627 | 12.380.085 |
| 224 M633 | 12.370.040 |
| 231 M635 | 12.380.030 |
| ** P103 | 500005496 |
| ** P170 | 12.390.040 |
| 243 P184 | 12.390.024 |
| 243 P185 | 12.390.025 |
| 242 P186 | 12.390.028 |
| 241 P187 | 12.390.036 |
| 241 P188 | 12.390.037 |
| 242 P196 | 12.390.031 |
| 218 S139 | 12.360.015 |
| 252 V201 | 12.420.015 |
| 253 V202 | 12.420.035 |
| 253 V203 | 12.420.040 |

ERF

| Pág. ERF | AIR-FREN |
|--------------|------------|
| 129 1065236 | 08.933.492 |
| 107 106524-2 | 05.700000 |
| 173 1065265 | 10.9640.00 |
| 104 106527-1 | 05.2458.50 |
| 185 1108718 | 10.5018.10 |
| 80 112861-3 | 03.527003 |
| 195 1136028 | 10.432407 |
| 145 1197265 | 09.051.132 |
| 195 1227404 | 10.432407 |
| 80 147190-5 | 03.527003 |

| Pág. ERF | AIR-FREN |
|-------------|------------|
| 130 4027060 | 08.8010.40 |
| 188 4054635 | 10.3200.50 |
| ** 4149419 | VG-3264 |

EVO-BUS

| Pág. EVO-BUS | AIR-FREN |
|-----------------|-------------|
| 312 0002506415 | 17.460.025 |
| 313 0002507615 | 17.460.035 |
| 323 0004202982 | 18.R650.075 |
| 323 0004203015 | 18.R650.070 |
| 162 0004295695 | 10.1867.70 |
| 314 0022504415 | 17.460.060 |
| 185 7788006000 | 10.5018.10 |
| 186 7788061000 | 10.5031.10 |
| 195 80250008580 | 10.432407 |
| 130 8025172000 | 08.3032.00 |
| 135 8025172000 | 08.3111.00 |
| 209 8241998710 | 11.R2961 |
| 105 82523016015 | 05.009300 |
| 108 8283422000 | 05.557005 |
| 183 82834756970 | 10.R8321 |
| 130 82836370000 | 08.8010.40 |
| 129 8283637000A | 08.933.492 |
| 121 8283699000 | 07.561007 |
| 192 8283848000 | 10.579015 |
| 67 82838950000 | 02.2020.00 |
| 173 8283905000 | 10.4750.00 |
| 107 82839400000 | 05.700000 |
| 67 8283985000 | 02.2020.00 |
| 191 8283987000 | 10.579013 |
| 173 8285177000 | 10.9640.00 |
| 107 8285274000 | 05.714000 |
| 141 8285280000 | 09.051.129 |
| 173 8285402000 | 10.9640.00 |
| 322 82855154680 | 18.R650.005 |
| 192 82855630000 | 10.579014 |
| 81 82855800000 | 03.527008 |
| 309 8383154000 | 17.430.020 |
| 309 8383189000 | 17.430.015 |
| 313 8383226185 | 17.460.040 |
| 146 8383231000 | 09.051.131 |
| 141 83832360000 | 09.051.114 |
| 146 8383240000 | 09.051.131 |
| 313 8383248000 | 17.460.040 |
| 312 8383282000 | 17.460.015 |
| 172 8633101000 | 10.4730.00 |
| 172 86331010440 | 10.R4730 |
| 152 89199177844 | 09.051.176 |
| 152 89199250134 | 09.051.183 |
| 312 A0012508815 | 17.460.015 |

FAG

| Pág. FAG | AIR-FREN |
|----------------|------------|
| 157 KG20001010 | 09.295.950 |
| 157 KG2000105 | 09.295.950 |
| 154 KG2202601 | 09.291.190 |
| 153 KG2302113 | 09.295.530 |
| 152 KG2302701 | 09.715.611 |
| 157 KG2303002 | 09.715.613 |
| 153 KG2303101 | 09.295.530 |

| Pág. FAG | AIR-FREN |
|----------------|-------------|
| 157 KG2371214 | 09.715.607 |
| 154 KG239512 | 09.295.820 |
| 155 KG239517 | 09.295.600 |
| 154 KG239517 | 09.295.820 |
| 153 KG25000402 | 09.361.136 |
| 155 KG259414 | 09.355.973 |
| 153 KG259615 | 09.446.414 |
| 152 KG259711 | 09.715.612 |
| 152 KG260211 | 09.295.300 |
| 152 KG260411 | 09.295.300 |
| 154 KG2801001 | 09.094.660 |
| 153 KG2801201 | 09.628.218 |
| 153 KG2801411 | 09.620.462 |
| 156 KG2802101 | 09.626.159 |
| 157 KN25021C1 | 09.716.605 |
| 157 KN25021D1 | 09.716.605 |
| 155 KN28022D1 | 09.295.540 |
| 154 KN3805J1 | 09.295.040 |
| 157 RK23513 | 09.R715.607 |
| 155 RK23714 | 09.R295.600 |
| 154 RK23714 | 09.R295.820 |
| 153 RK23716 | 09.R295.530 |
| 152 RK23722 | 09.R715.611 |
| 157 RK23722 | 09.R715.613 |
| 155 RK23726 | 09.R295.600 |
| 155 RK25703 | 09.R355.973 |
| 153 RK25705 | 09.R446.414 |
| 152 RK25706 | 09.R715.612 |
| 152 RK26504 | 09.R295.300 |
| 153 RK2866 | 09.R620.462 |
| 154 RK28706 | 09.R094.660 |
| 153 RK28710 | 09.R620.462 |
| 153 RK28710 | 09.R628.218 |
| 155 RK28813K | 09.R295.540 |
| 154 RK38816K | 09.R295.040 |

FAUN

| Pág. FAUN | AIR-FREN |
|-----------------|-------------|
| 309 0890238 | 17.430.030 |
| 309 0890340 | 17.430.020 |
| 312 0890591 | 17.460.030 |
| 121 1612011 | 07.561008 |
| 121 1612023 | 07.561007 |
| 121 1612036 | 07.561007 |
| 80 1617 213 | 03.527003 |
| 67 1619285 | 02.2424.00 |
| 191 1627047 | 10.579013 |
| 191 1627067 | 10.579013 |
| 193 1658005 | 10.1100.00 |
| 193 1658007 | 10.1100.00 |
| 309 36300898151 | 17.430.030 |
| 105 7005416 | 05.009300 |
| 82 8411966 | 03.105508 |
| 80 9970 8458694 | 03.527003 |
| 183 99700215253 | 10.3200.60 |
| 161 99707004741 | 10.410106 |
| 195 99707004743 | 10.432407.1 |
| 116 99707005559 | 06.559150 |
| 80 99707005867 | 03.527001 |
| 185 99707006699 | 10.5018.00 |
| 310 99707010805 | 17.440.010 |
| 145 99707308039 | 09.051.132 |

| Pág. FAUN | AIR-FREN |
|-----------------|------------|
| 195 99707730468 | 10.432407 |
| 191 99708410810 | 10.579013 |
| 181 99708412380 | 10.R5210 |
| 149 99708436147 | 09.051.102 |
| 185 99708458362 | 10.5018.10 |
| 97 99708458682 | 04.4225.00 |
| 67 99708458792 | 02.3630.00 |
| 172 99708460743 | 10.R4720 |

FODEN

| Pág. FODEN | AIR-FREN |
|-----------------|------------|
| 147 4200022001 | 09.1605.00 |
| 141 4200160000 | 09.051.114 |
| 107 5100533000 | 05.700000 |
| 107 5100655-000 | 05.714000 |

FRENELSA

| Pág. FRENELSA | AIR-FREN |
|---------------|------------|
| 303 122013 | 16.6490.00 |

FRUEHAUF

| Pág. FRUEHAUF | AIR-FREN |
|--------------------------|------------|
| 287 10220 | 14.F.37 |
| 276 10240 | 13.69004 |
| ** 10311 | 500002712 |
| 303 10336 | 16.6590.00 |
| 285 21504 | 14.21.500 |
| 178 36546 | 10.930.930 |
| 129 36548 | 08.933.492 |
| 102 51112 | 05.30300 |
| 107 51112 | 05.7558.50 |
| 103 51180 | 05.2458.49 |
| 182 51206 | 10.4395.10 |
| 106 51253 | 05.712000 |
| 103 51255 | 05.605733 |
| 178 51256 | 10.543002 |
| 106 51286 | 05.533001 |
| 103 51350 | 05.235546 |
| 101 51538 | 05.545003 |
| 285 72014 | 14.4315.2 |
| 129 AFA1658001 | 08.933.492 |
| 107 AFA4271004 | 05.700000 |
| 107 AJA0976-2/A-32167-00 | 05.700000 |
| 129 ASZ062110027565P | 08.933.492 |
| 186 C002039-01 | 10.5031.00 |
| 107 CF351301 | 05.700000 |
| 107 CF351826 | 05.714000 |
| 130 CF351925F001882 | 08.3032.00 |
| 135 CF351925F001882 | 08.3111.00 |
| 130 CF351950F001572 | 08.8010.40 |
| 186 CF352057 | 10.5031.10 |
| 186 CF352791 | 10.5031.00 |
| 107 F001165 | 05.714000 |
| 130 F001572 | 08.8010.40 |
| 186 F002005 | 10.5031.10 |
| 304 M003125 | 16.6590.10 |
| 304 M076995 | 16.6590.30 |
| 304 M077010 | 16.6590.20 |

| Pág. | FRUEHAUF | AIR-FREN |
|------|----------|------------|
| 177 | MO58229 | 10.8400.00 |

FTE

| Pág. | FTE | AIR-FREN |
|------|-------|------------|
| 157 | S5294 | 09.715.607 |
| 153 | S5315 | 09.446.414 |
| 157 | S5571 | 09.715.613 |
| 157 | S6167 | 09.716.605 |

GOLDHOFER

| Pág. | GOLDHOFER | AIR-FREN |
|------|-----------|------------|
| 93 | 150166 | 04.4213.00 |
| 67 | 150950 | 02.3630.00 |
| 121 | 150972 | 07.561007 |
| 192 | 151165 | 10.579015 |
| 173 | 151168 | 10.9640.00 |
| 129 | 151169 | 08.933.492 |
| 104 | 152092 | 05.2458.50 |
| 183 | 155671 | 10.3200.60 |
| 107 | 156864 | 05.714000 |
| 186 | 157395 | 10.5031.10 |
| 130 | 157537 | 08.8010.40 |
| 188 | 158785 | 10.3200.50 |
| 130 | 159118 | 08.3032.00 |
| 135 | 159118 | 08.3111.00 |
| 177 | 163321 | 10.8400.00 |
| 108 | 163414 | 05.557006 |
| 131 | 164789 | 08.4410.60 |
| 108 | 200286 | 05.557005 |
| 107 | 200659 | 05.700000 |

HALDEX

| Pág. | HALDEX | AIR-FREN |
|------|------------|--------------|
| ** | 014114309 | 5820087 |
| 71 | 025050809 | 02.1627L |
| 62 | 030351609 | 01.2760.60 |
| 62 | 030351809 | 01.3100.60 |
| 161 | 031004109 | 10.1867.10 |
| 287 | 100001021 | 14.L.10C |
| 287 | 100001721 | 14.L.10L |
| 287 | 100016170 | 14.I.8L |
| 287 | 100016970 | 14.I.8C |
| 287 | 100114075 | 14.F.37 |
| 65 | 120350203 | 02.239.024.1 |
| 68 | 122001041 | 02.2430.80 |
| 68 | 122002041 | 02.3030.80 |
| 69 | 1351624004 | 02.1624.50 |
| 69 | 1351624010 | 02.1624.50 |
| 102 | 201002001 | 05.7558.00 |
| 183 | 206005001 | 10.4375.10 |
| 10 | 301200115 | 01.2320.80 |
| 178 | 310005011 | 10.930.930 |
| 178 | 310007011 | 10.930.930 |
| 125 | 312012012 | 07.3550.20 |
| 123 | 312013012 | 07.055522 |
| 123 | 312013012 | 07.561003 |
| 123 | 312013015 | 07.065522 |
| 123 | 312017012 | 07.045522 |

| Pág. | HALDEX | AIR-FREN |
|------|----------------|--------------|
| 123 | 312017014 | 07.045522 |
| 121 | 312018001 | 07.561008 |
| 121 | 312029012 | 07.561007 |
| 123 | 312029014 | 07.045522 |
| 123 | 312030001 | 07.015467 |
| 121 | 312030001 | 07.561001 |
| 121 | 312030001 | 07.561002 |
| 183 | 314001001 | 10.2440.15 |
| 182 | 314012001 | 10.2950.35 |
| 182 | 314012002 | 10.2950.60 |
| 182 | 314012003 | 10.2950.65 |
| 182 | 314012004 | 10.2950.90 |
| 182 | 314012005 | 10.2950.20 |
| 182 | 314013001 | 10.2950.50 |
| 182 | 314013001 | 10.2950.55 |
| 182 | 314013003 | 10.2950.60 |
| 182 | 314013003 | 10.2950.70 |
| 182 | 314013005 | 10.2950.10 |
| 182 | 314013006 | 10.2950.05 |
| 182 | 314013008 | 10.2950.00 |
| 182 | 314013009 | 10.2950.40 |
| 182 | 314013012 | 10.2950.15 |
| 115 | 314023001 | 06.539110 |
| ** | 314023001 | 3150-10 |
| 115 | 314030001 | 06.559110 |
| 116 | 314030001 | 06.569110 |
| 115 | 314037001 | 06.559110 |
| 116 | 314045001 | 06.569110 |
| 116 | 314059001 | 06.6050.60 |
| 115 | 314060001 | 06.539110 |
| 116 | 314073001 | 06.569110 |
| 116 | 314096001 | 06.6050.60 |
| ** | 314096001 | 314.096.501 |
| 116 | 314096501 | 06.6050.60 |
| 182 | 314110001 | 10.2950.80 |
| 178 | 315007001 | 10.055527 |
| 183 | 315016001 | 10.8321.00 |
| 183 | 315019001 | 10.4375.10 |
| 80 | 320003103 | 03.240.654.0 |
| 79 | 320015001 | 03.1900.00 |
| 79 | 320018001 | 03.1900.20 |
| 79 | 320021001 | 03.1900.10 |
| 80 | 320023001 | 03.527003 |
| 83 | 320060001 | 03.527013 |
| 83 | 320060012 | 03.527013 |
| 83 | 320060101 | 03.527013 |
| 83 | 320060112 | 03.527013 |
| 83 | 320060123 | 03.527013 |
| 80 | 320065001 | 03.527001 |
| 83 | 320065121 | |
| | Con pipeta | |
| | descarga recta | 03.527013 |
| 93 | 328011031 | 04.4212.00 |
| 93 | 328013031 | 04.4211.00 |
| 176 | 332005021 | 10.559001 |
| 183 | 333004001 | 10.3200.30 |
| 182 | 334003001 | 10.4395.10 |
| 191 | 334025031 | 10.579004 |
| 191 | 334026031 | 10.579003 |
| 182 | 334047001 | 10.4395.10 |
| 191 | 334054001 | 10.579002 |
| 191 | 334055001 | 10.579001 |
| 191 | 334063001 | 10.579005 |
| 191 | 334064001 | 10.579006 |

| Pág. | HALDEX | AIR-FREN |
|------|-----------|-------------|
| 182 | 334077001 | 10.4395.10 |
| 98 | 338021001 | 04.4235.00 |
| 172 | 338050001 | 10.3380.00 |
| 172 | 338050101 | 10.3380.00 |
| 75 | 340005001 | 02.1350.20 |
| 75 | 340006001 | 02.1350.20 |
| 75 | 340008001 | 02.1400.10 |
| 75 | 340010001 | 02.1400.10 |
| 174 | 341004011 | 10.1883.20 |
| 67 | 346022001 | 02.2024.00 |
| 67 | 346026001 | 02.2024.00 |
| 67 | 346031001 | 02.2424.00 |
| 67 | 346033001 | 02.1624.00 |
| 67 | 346068001 | 02.2424.00 |
| 67 | 346080001 | 02.2024.00 |
| 67 | 346081001 | 02.2024.00 |
| 67 | 346082001 | 02.2424.00 |
| 67 | 346083001 | 02.2424.00 |
| 67 | 346084001 | 02.2024.00 |
| 67 | 346085001 | 02.2424.00 |
| 67 | 346093001 | 02.2024.00 |
| 68 | 346181001 | 02.2430.80 |
| 68 | 346182011 | 02.3030.80 |
| 69 | 346183001 | 02.1624.50 |
| 69 | 346186001 | 02.1824.50 |
| 69 | 346187001 | 02.2024.50 |
| 103 | 350026002 | 05.2750.70 |
| 104 | 351008022 | 05.557007 |
| 111 | 351012001 | 05.2440.12 |
| 111 | 351014001 | 05.2440.14 |
| 103 | 352011122 | 05.605733 |
| 103 | 352012001 | 05.2458.49 |
| 104 | 352018001 | 05.3520.18 |
| 104 | 352019001 | 05.3520.19 |
| ** | 352044001 | 352.044.001 |
| ** | 355014001 | 05.3750.00 |
| 101 | 355018011 | 05.545003 |
| 101 | 355018071 | 05.135517 |
| 105 | 355019011 | 05.557004 |
| 105 | 355020011 | 05.557004 |
| 101 | 355023011 | 05.545004 |
| 101 | 355024001 | 05.575537 |
| 101 | 355024011 | 05.575537 |
| 101 | 355024501 | 05.575537 |
| 105 | 355026011 | 05.557002 |
| 105 | 355027011 | 05.557001 |
| 105 | 355027013 | 05.557001 |
| 105 | 355045001 | 05.557002 |
| 105 | 355082001 | 05.009000 |
| 101 | 355093001 | 05.575537 |
| 198 | 356001001 | 10.3300.10 |
| 178 | 356006011 | 10.543002 |
| 179 | 356009011 | 10.543012 |
| 178 | 356023001 | 10.543082 |
| 178 | 356023011 | 10.543082 |
| 181 | 357004021 | 10.5210.60 |
| 181 | 357004022 | 10.5210.10 |
| 181 | 357012034 | 10.5210.60 |
| 181 | 357013001 | 10.5310.80 |
| ** | 364114021 | 364.114.021 |
| ** | 364115001 | 364.115.021 |
| 186 | 364115021 | 10.3640.00 |
| ** | 364115021 | 364.115.021 |
| ** | 364116021 | 364.116.021 |

| Pág. | HALDEX | AIR-FREN |
|------|-------------------|---------------|
| 277 | 47263 | 13.37263 |
| 277 | 47359 | 13.37359 |
| 267 | 5430060288 | 13.69683 |
| 267 | 5430060289 | 13.69684 |
| 107 | 601001001 | 05.6120.40 |
| 107 | 602005001 | 05.700000 |
| ** | 602005001 | R602.005.001 |
| 129 | 612011011 | 08.933.492 |
| 129 | 612017071 | 08.933.492 |
| 130 | 612017091 | 08.8010.40 |
| ** | 612017091 | SV-1395 |
| 130 | 612032001 | 08.8010.50 |
| ** | 612032001 | SV-1410 |
| 129 | 612035011 | 08.933.492 |
| 132 | 612035021 | 08.8010.100 |
| 130 | 612035021 | 08.8010.40 |
| 129 | 612035041 | |
| | Con racor raufoss | 08.933.492 |
| ** | 613005001 | 475.800.301.0 |
| 277 | 63008 | 13.53008 |
| 271 | 70635 | 13.60635 |
| 269 | 70661 | 13.62654 |
| 271 | 70672 | 13.60922 |
| 271 | 70673 | 13.60921 |
| 265 | 70706 | 13.60706 |
| 263 | 70722 | 13.62320 |
| 263 | 70723 | 13.62320 |
| 263 | 70723 | 13.62321 |
| 263 | 70724 | 13.62321 |
| 263 | 70730 | 13.60964 |
| 263 | 70730 | 13.62508 |
| 263 | 70731 | 13.60965 |
| 263 | 70731 | 13.62509 |
| 263 | 70734 | 13.62322 |
| 265 | 70753 | 13.60753 |
| 265 | 70754 | 13.60754 |
| 265 | 70771 | 13.60771 |
| 265 | 70772 | 13.60772 |
| 265 | 70775 | 13.60775 |
| ** | 70864 | 13.60864 |
| 269 | 70864 | 13.62622 |
| 265 | 70867 | 13.62308 |
| 269 | 70878 | 13.62624 |
| 269 | 70878 | 13.62660 |
| 269 | 70879 | 13.62625 |
| 269 | 70879 | 13.62661 |
| 271 | 70920 | 13.60920 |
| 271 | 70921 | 13.60921 |
| 271 | 70922 | 13.60922 |
| 271 | 70923 | 13.60923 |
| 271 | 70924 | 13.60924 |
| 269 | 70937 | 13.62620 |
| 269 | 70938 | 13.62621 |
| 265 | 70952 | 13.60952 |
| 265 | 70953 | 13.60953 |
| 265 | 70954 | 13.60954 |
| 263 | 70962 | 13.62987 |
| 263 | 70963 | 13.62988 |
| 263 | 70964 | 13.60964 |
| 263 | 70964 | 13.62508 |
| 263 | 70965 | 13.60965 |
| 263 | 70965 | 13.62509 |
| 265 | 70966 | 13.60775 |
| 269 | 70974 | 13.62654 |

CRUCE DE REFERENCIAS: REFERENCIAS ORIGINALES / AIR FREN

CROSS REFERENCE LIST: ORIGINAL REFERENCES / AIR FREN

| Pág. | HALDEX | AIR-FREN | Pág. | HALDEX | AIR-FREN | Pág. | HALDEX | AIR-FREN | Pág. | HALDEX | AIR-FREN |
|------|--------------------|------------|------|--------|----------|------|--------|----------|------|--------|----------|
| 162 | 71034 | 10.1867.30 | 267 | 72318 | 13.62318 | 269 | 72624 | 13.62624 | 269 | 72892 | 13.62469 |
| ** | 71323 | 71323 | 267 | 72319 | 13.62319 | 269 | 72624 | 13.62660 | 269 | 72893 | 13.62468 |
| 164 | 71360 | 10.410113 | 263 | 72320 | 13.62320 | 269 | 72625 | 13.62625 | 273 | 72929 | 13.69462 |
| ** | 71360 | 92695 | 263 | 72321 | 13.62321 | 269 | 72625 | 13.62661 | 273 | 72930 | 13.69463 |
| 164 | 71361 | 10.410113 | 263 | 72322 | 13.62322 | 269 | 72628 | 13.62628 | 276 | 72948 | 13.62250 |
| 164 | 71362 | | 261 | 72327 | 13.62547 | 269 | 72629 | 13.62629 | 269 | 72949 | 13.62624 |
| | Con racor M22-1/2" | 10.410113 | 273 | 72408 | 13.62408 | 269 | 72630 | 13.62630 | 269 | 72949 | 13.62660 |
| 164 | 71368 | 10.410113 | 263 | 72414 | 13.62012 | 269 | 72631 | 13.62631 | 269 | 72950 | 13.62625 |
| 164 | 71369 | 10.410113 | 263 | 72415 | 13.62013 | 269 | 72632 | 13.62654 | 269 | 72950 | 13.62661 |
| 164 | 71756 | 10.410113 | 263 | 72455 | 13.62455 | 269 | 72654 | 13.62654 | 269 | 72951 | 13.62620 |
| 267 | 72005 | 13.62005 | 263 | 72456 | 13.62456 | 269 | 72660 | 13.62624 | 269 | 72952 | 13.62621 |
| 267 | 72006 | 13.62006 | 269 | 72464 | 13.62654 | 269 | 72660 | 13.62660 | 269 | 72953 | 13.62654 |
| 263 | 72012 | 13.62012 | 269 | 72467 | 13.62622 | 269 | 72661 | 13.62625 | 269 | 72958 | 13.62630 |
| 263 | 72013 | 13.62013 | 269 | 72468 | 13.62468 | 269 | 72661 | 13.62661 | 269 | 72959 | 13.62631 |
| 271 | 72022 | 13.62672 | 269 | 72469 | 13.62469 | 269 | 72662 | 13.62622 | 269 | 72960 | 13.62729 |
| 271 | 72023 | 13.62673 | 269 | 72478 | 13.62478 | 269 | 72663 | 13.62620 | 269 | 72961 | 13.62730 |
| 271 | 72026 | 13.62676 | 269 | 72486 | 13.62620 | 269 | 72664 | 13.62621 | 269 | 72962 | 13.62654 |
| 265 | 72038 | 13.62038 | 269 | 72487 | 13.62621 | 271 | 72668 | 13.60921 | 269 | 72963 | 13.62622 |
| 265 | 72039 | 13.62039 | 269 | 72488 | 13.62630 | 271 | 72669 | 13.60922 | 263 | 72965 | 13.62012 |
| 265 | 72040 | 13.62040 | 269 | 72489 | 13.62631 | 271 | 72670 | 13.60923 | 263 | 72966 | 13.62013 |
| 265 | 72041 | 13.62041 | 269 | 72490 | 13.62654 | 271 | 72671 | 13.60924 | 263 | 72968 | 13.62303 |
| 265 | 72059 | 13.62059 | 269 | 72491 | 13.62624 | 271 | 72672 | 13.62672 | 263 | 72969 | 13.62304 |
| 261 | 72107 | 13.62523 | 269 | 72491 | 13.62660 | 271 | 72673 | 13.62673 | 263 | 72970 | 13.62320 |
| 261 | 72108 | 13.62524 | 269 | 72492 | 13.62625 | 271 | 72676 | 13.62676 | 263 | 72971 | 13.62321 |
| 261 | 72109 | 13.62525 | 269 | 72492 | 13.62661 | 271 | 72678 | 13.62678 | 263 | 72972 | 13.62322 |
| 261 | 72110 | 13.62526 | 263 | 72508 | 13.60964 | 269 | 72690 | 13.62690 | 263 | 72981 | 13.62455 |
| 271 | 72152 | 13.62782 | 263 | 72508 | 13.62508 | 269 | 72691 | 13.62691 | 263 | 72982 | 13.62456 |
| 271 | 72153 | 13.62783 | 263 | 72509 | 13.60965 | 261 | 72704 | 13.62704 | 263 | 72985 | 13.60964 |
| 267 | 72160 | 13.62160 | 263 | 72509 | 13.62509 | 261 | 72705 | 13.62705 | 263 | 72985 | 13.62508 |
| 267 | 72161 | 13.62161 | 263 | 72512 | 13.62987 | 271 | 72713 | 13.60635 | 263 | 72986 | 13.60965 |
| 267 | 72162 | 13.62162 | 263 | 72513 | 13.62988 | 271 | 72726 | 13.62726 | 263 | 72986 | 13.62509 |
| 267 | 72163 | 13.62163 | 261 | 72523 | 13.62523 | 269 | 72729 | 13.62478 | 263 | 72987 | 13.62987 |
| 261 | 72164 | 13.62532 | 261 | 72524 | 13.62524 | 269 | 72729 | 13.62729 | 263 | 72988 | 13.62988 |
| 261 | 72165 | 13.62533 | 261 | 72525 | 13.62525 | 269 | 72730 | 13.62730 | 263 | 72989 | 13.62578 |
| 271 | 72166 | 13.62678 | 261 | 72526 | 13.62526 | 267 | 72738 | 13.62738 | ** | 72994 | 13.62994 |
| 271 | 72167 | 13.62726 | 261 | 72532 | 13.62532 | 267 | 72739 | 13.62739 | 267 | 72997 | 13.62997 |
| 265 | 72173 | 13.62173 | 261 | 72533 | 13.62533 | 267 | 72740 | 13.62740 | 267 | 72998 | 13.62998 |
| 265 | 72174 | 13.62174 | 261 | 72534 | 13.62197 | 267 | 72741 | 13.62741 | ** | 74181 | 13.181 |
| 261 | 72197 | 13.62197 | 261 | 72535 | 13.62535 | 271 | 72782 | 13.62782 | 276 | 74228 | 13.228 |
| 261 | 72202 | 13.62535 | 261 | 72536 | 13.62536 | 271 | 72783 | 13.62783 | 276 | 74229 | 13.229 |
| 263 | 72208 | 13.62208 | 261 | 72537 | 13.62537 | 271 | 72784 | 13.62232 | 276 | 74230 | 13.230 |
| 265 | 72211 | 13.62211 | 261 | 72538 | 13.62538 | 271 | 72785 | 13.62233 | 276 | 74234 | 13.234 |
| 265 | 72212 | 13.62212 | 261 | 72539 | 13.62539 | 267 | 72786 | 13.62786 | 276 | 74235 | 13.235 |
| 265 | 72213 | 13.62213 | 261 | 72540 | 13.62540 | 267 | 72787 | 13.62787 | 276 | 74258 | 13.785 |
| 261 | 72223 | 13.62536 | 261 | 72542 | 13.62542 | 276 | 72788 | 13.62788 | 276 | 74287 | 13.785 |
| 261 | 72224 | 13.62537 | 261 | 72543 | 13.62543 | 267 | 72798 | 13.62798 | 276 | 74363 | 13.557 |
| 271 | 72232 | 13.62232 | 261 | 72544 | 13.62544 | 267 | 72798 | 13.69294 | 276 | 74369 | 13.556 |
| 271 | 72233 | 13.62233 | 261 | 72545 | 13.62545 | 267 | 72799 | 13.62799 | 276 | 74372 | 13.372 |
| 265 | 72234 | 13.62234 | 261 | 72546 | 13.62546 | 267 | 72799 | 13.69295 | 276 | 74374 | 13.374 |
| 265 | 72235 | 13.62235 | 261 | 72547 | 13.62547 | 273 | 72804 | 13.62804 | 276 | 74387 | 13.688 |
| 269 | 72247 | 13.62630 | 263 | 72578 | 13.62578 | 263 | 72809 | 13.62455 | 276 | 74414 | 13.444 |
| 269 | 72248 | 13.62631 | 265 | 72593 | 13.62593 | 265 | 72809 | 13.62809 | 276 | 74444 | 13.444 |
| 276 | 72250 | 13.62250 | 265 | 72594 | 13.62594 | 263 | 72810 | 13.62456 | 276 | 74448 | 13.448 |
| 276 | 72254 | 13.69004 | 265 | 72596 | 13.62596 | 265 | 72810 | 13.62810 | 276 | 74453 | 13.453 |
| 261 | 72301 | 13.62539 | 261 | 72608 | 13.62608 | 265 | 72811 | 13.62811 | ** | 74455 | 13.455 |
| 261 | 72302 | 13.62538 | 261 | 72609 | 13.62609 | 265 | 72812 | 13.62812 | 276 | 74472 | 13.472 |
| 263 | 72303 | 13.62303 | 265 | 72616 | 13.60953 | 267 | 72813 | 13.62813 | 276 | 74476 | 13.476 |
| 263 | 72304 | 13.62304 | 265 | 72616 | 13.62616 | 267 | 72814 | 13.62814 | ** | 74493 | 13.455 |
| 261 | 72305 | 13.62540 | 265 | 72617 | 13.60952 | 269 | 72825 | 13.62630 | 276 | 74500 | 13.688 |
| 265 | 72308 | 13.62308 | 265 | 72617 | 13.62617 | 269 | 72826 | 13.62631 | 276 | 74501 | 13.229 |
| 261 | 72310 | 13.62542 | 269 | 72620 | 13.62620 | 267 | 72835 | 13.62835 | 276 | 74505 | 13.235 |
| 261 | 72311 | 13.62543 | 269 | 72621 | 13.62621 | 267 | 72836 | 13.62836 | 276 | 74506 | 13.234 |
| 261 | 72312 | 13.62544 | 269 | 72622 | 13.62622 | 276 | 72875 | 13.62875 | 276 | 74555 | 13.555 |
| 261 | 72313 | 13.62545 | 269 | 72623 | 13.62654 | 276 | 72876 | 13.62876 | 276 | 74556 | 13.556 |



| Pág. | HALDEX | AIR-FREN |
|------|--------|------------|
| 276 | 74557 | 13.557 |
| 276 | 74558 | 13.558 |
| 276 | 74560 | 13.560 |
| 276 | 74564 | 13.564 |
| 276 | 74565 | 13.565 |
| 276 | 74566 | 13.566 |
| 276 | 74632 | 13.635 |
| 276 | 74635 | 13.635 |
| 276 | 74682 | 13.682 |
| 276 | 74686 | 13.686 |
| 276 | 74687 | 13.687 |
| 276 | 74688 | 13.688 |
| 276 | 74729 | 13.453 |
| 276 | 74738 | 13.738 |
| 276 | 74760 | 13.229 |
| 276 | 74782 | 13.782 |
| 276 | 74784 | 13.560 |
| 276 | 74785 | 13.785 |
| 276 | 74788 | 13.788 |
| 276 | 74802 | 13.802 |
| 276 | 74808 | 13.808 |
| 276 | 74854 | 13.854 |
| 276 | 74861 | 13.861 |
| 276 | 74862 | 13.788 |
| 276 | 74864 | 13.864 |
| 276 | 74900 | 13.557 |
| 276 | 74988 | 13.785 |
| 276 | 74992 | 13.992 |
| 277 | 76046 | 13.66046 |
| 277 | 78340 | 13.76906 |
| 162 | 78964 | 10.1867.80 |
| 276 | 79004 | 13.69004 |
| 276 | 79005 | 13.69331 |
| 267 | 79007 | 13.62005 |
| 267 | 79008 | 13.62006 |
| 267 | 79013 | 13.62160 |
| 267 | 79014 | 13.62161 |
| 267 | 79015 | 13.62162 |
| 267 | 79016 | 13.62163 |
| 267 | 79017 | 13.62318 |
| 267 | 79018 | 13.62319 |
| 276 | 79022 | 13.69022 |
| 276 | 79023 | 13.69004 |
| 261 | 79024 | 13.69024 |
| 261 | 79025 | 13.69025 |
| 269 | 79033 | 13.69033 |
| 269 | 79034 | 13.69034 |
| 271 | 79072 | 13.69072 |
| 267 | 79075 | 13.69308 |
| 267 | 79076 | 13.69309 |
| 267 | 79077 | 13.69077 |
| 267 | 79078 | 13.69078 |
| 276 | 79112 | 13.69112 |
| 271 | 79178 | 13.60920 |
| 263 | 79205 | 13.62012 |
| 263 | 79206 | 13.62013 |
| 263 | 79207 | 13.62208 |
| 263 | 79208 | 13.62303 |
| 263 | 79209 | 13.62304 |
| 263 | 79210 | 13.62320 |
| 263 | 79211 | 13.62321 |
| 263 | 79212 | 13.62322 |
| 263 | 79219 | 13.62455 |
| 263 | 79220 | 13.62456 |

| Pág. | HALDEX | AIR-FREN |
|------|--------|----------|
| 263 | 79223 | 13.60964 |
| 263 | 79223 | 13.62508 |
| 263 | 79224 | 13.60965 |
| 263 | 79224 | 13.62509 |
| 263 | 79225 | 13.62987 |
| 263 | 79226 | 13.62988 |
| 263 | 79227 | 13.62578 |
| 276 | 79235 | 13.62788 |
| 267 | 79286 | 13.62738 |
| 267 | 79287 | 13.62739 |
| 267 | 79288 | 13.62740 |
| 267 | 79289 | 13.62741 |
| 267 | 79290 | 13.62786 |
| 267 | 79291 | 13.62787 |
| 267 | 79294 | 13.62798 |
| 267 | 79294 | 13.69294 |
| 267 | 79295 | 13.62799 |
| 267 | 79295 | 13.69295 |
| 267 | 79296 | 13.62813 |
| 267 | 79297 | 13.62814 |
| 267 | 79299 | 13.62835 |
| 267 | 79300 | 13.62836 |
| 267 | 79304 | 13.62997 |
| 267 | 79305 | 13.62998 |
| 267 | 79308 | 13.69308 |
| 267 | 79309 | 13.69309 |
| 267 | 79310 | 13.69077 |
| 267 | 79311 | 13.69078 |
| 276 | 79331 | 13.69331 |
| 269 | 79347 | 13.62628 |
| 269 | 79348 | 13.62629 |
| 269 | 79368 | 13.62690 |
| 269 | 79369 | 13.62691 |
| ** | 79441 | 13.62994 |
| 269 | 79442 | 13.69033 |
| 269 | 79443 | 13.69034 |
| 273 | 79462 | 13.69462 |
| 273 | 79463 | 13.69463 |
| 271 | 79564 | 13.69072 |
| 271 | 79677 | 13.69677 |
| 271 | 79678 | 13.69678 |
| 267 | 79683 | 13.69683 |
| 267 | 79684 | 13.69684 |
| 265 | 80000 | 13.60952 |
| 265 | 80000 | 13.62616 |
| 275 | 80000C | 13.90000 |
| 265 | 80001 | 13.60953 |
| 275 | 80001C | 13.90001 |
| 265 | 80008 | 13.62234 |
| 265 | 80008 | 13.62593 |
| 275 | 80008C | 13.90008 |
| 265 | 80009 | 13.62235 |
| 265 | 80009 | 13.62594 |
| 275 | 80009C | 13.90009 |
| 275 | 80010C | 13.90010 |
| 275 | 80011C | 13.90011 |
| 265 | 80012 | 13.62040 |
| 275 | 80012C | 13.90012 |
| 265 | 80013 | 13.62041 |
| 275 | 80013C | 13.90013 |
| 275 | 80014C | 13.90014 |
| 275 | 80019S | 13.90019 |
| 276 | 80020 | 13.62788 |
| 275 | 80020S | 13.90020 |

| Pág. | HALDEX | AIR-FREN |
|------|-----------|--------------|
| 275 | 80021S | 13.90021 |
| 275 | 80022S | 13.90022 |
| 275 | 80023S | 13.90023 |
| 275 | 80024S | 13.90024 |
| 275 | 80030C | 13.90030 |
| 275 | 80041C | 13.90041 |
| 275 | 80092C | 13.90010 |
| 275 | 80093C | 13.90011 |
| 275 | 80180C | 13.90010 |
| 275 | 80181C | 13.90011 |
| 164 | 89335 | 10.410113 |
| 190 | 90054074 | 10.9005.25 |
| 190 | 90054075 | 10.9005.20 |
| 190 | 90054076 | 10.9005.30 |
| 190 | 90054079 | 10.9005.10 |
| 190 | 90054088 | 10.9005.15 |
| 138 | 90554241 | 08.9055.30 |
| 138 | 90554243 | 08.9055.40 |
| 138 | 90554271 | 08.9055.50 |
| 138 | 90554273 | 08.9055.60 |
| 138 | 90554663 | 08.8718.10 |
| 164 | 92695 | 10.410113 |
| ** | 92695 | 92695 |
| 102 | 950035004 | 05.R035004 |
| 80 | 950320002 | 03.R2300 |
| 79 | 950320010 | 03.R1900 |
| 172 | 950338022 | 10.R3380 |
| 211 | 950351004 | 11.R2750 |
| 111 | 950351005 | 05.R7000 |
| 211 | 950352003 | 11.R3700E |
| 186 | 950364047 | 10.3640.00 |
| ** | 950364047 | 364.115.021 |
| 102 | KN30300 | 05.30300 |
| 107 | KN30300 | 05.7558.50 |
| 9 | KS70T | 01.1100.20 |
| ** | KS70T | 01.230.104.0 |
| 102 | RN10HL | 05.R035004 |

ILASA

| Pág. | ILASA | AIR-FREN |
|------|------------|--------------|
| 75 | 9901203 | 02.1400.10 |
| 65 | 99012031 | 02.239.024.1 |
| 65 | 99012032 | 02.239.030.1 |
| 65 | 99012033 | 02.239.020.1 |
| 287 | 9901413 | 14.1.8L |
| 287 | 9902413 | 14.1.8C |
| 304 | 9944514-15 | 16.6690.00 |
| 304 | 9945511 | 16.6790.00 |
| 285 | 9945912 | 14.21.500 |

IVECO

| Pág. | IVECO | AIR-FREN |
|------|----------|------------|
| 309 | 00100128 | 17.430.020 |
| 191 | 011113 | 10.579005 |
| 191 | 011114 | 10.579006 |
| 17 | 01173850 | 01.1200.20 |
| 17 | 01173860 | 01.1200.20 |
| 17 | 01174472 | 01.1200.20 |
| 183 | 01236222 | 10.3200.30 |
| 17 | 01260642 | 01.1200.20 |

| Pág. | IVECO | AIR-FREN |
|------|----------|------------|
| 17 | 01260651 | 01.1200.20 |
| 309 | 01261558 | 17.430.020 |
| 17 | 01261655 | 01.1200.20 |
| 141 | 01261885 | 09.051.114 |
| 17 | 01262046 | 01.1200.20 |
| 71 | 01271506 | 02.1802 |
| 309 | 01398598 | 17.430.020 |
| 310 | 01805282 | 17.440.010 |
| 310 | 01805282 | 17.440.020 |
| 310 | 01903899 | 17.440.015 |
| 310 | 01903936 | 17.440.015 |
| 310 | 01904756 | 17.440.010 |
| 310 | 01904779 | 17.440.020 |
| 310 | 01904785 | 17.440.010 |
| 310 | 01904785 | 17.440.020 |
| 310 | 01904796 | 17.440.010 |
| 310 | 01905282 | 17.440.010 |
| 310 | 01905282 | 17.440.020 |
| 310 | 01908508 | 17.440.010 |
| 310 | 01908518 | 17.440.010 |
| 310 | 01908524 | 17.440.010 |
| 309 | 02440924 | 17.430.030 |
| 310 | 02443133 | 17.440.015 |
| 101 | 02444906 | 05.545003 |
| 81 | 02470415 | 03.491102 |
| 309 | 02475546 | 17.430.010 |
| 309 | 02475547 | 17.430.010 |
| 310 | 02475629 | 17.440.015 |
| 141 | 02477724 | 09.051.114 |
| 310 | 02479048 | 17.440.015 |
| 173 | 02513123 | 10.9640.00 |
| 191 | 02516792 | 10.579013 |
| 191 | 02516808 | 10.579013 |
| 191 | 02516902 | 10.579013 |
| 66 | 02520947 | 02.1609.00 |
| 191 | 02521371 | 10.579013 |
| 66 | 02523486 | 02.1612.20 |
| 133 | 02532579 | 08.1260.00 |
| 309 | 02565803 | 17.430.010 |
| 71 | 02661819 | 02.1616 |
| 71 | 02961819 | 02.1616 |
| 82 | 02965367 | 03.105508 |
| 93 | 02968592 | 04.R4212 |
| 182 | 02968769 | 10.R1965 |
| 101 | 02968774 | 05.R645002 |
| ** | 02969968 | 10.R3200E |
| 93 | 02980306 | 04.R631003 |
| 82 | 02982457 | 03.105508 |
| 193 | 03410499 | 10.1100.00 |
| 121 | 03410537 | 07.561008 |
| 121 | 03410538 | 07.561008 |
| 183 | 03420514 | 10.3200.60 |
| 290 | 03423571 | 14.7031.00 |
| 309 | 03428017 | 17.430.030 |
| 121 | 03429296 | 07.561008 |
| 81 | 03435131 | 03.491102 |
| 66 | 04462022 | 02.1609.00 |
| 116 | 04462569 | 06.6050.60 |
| 66 | 04462759 | 02.1612.00 |
| 66 | 04462760 | 02.1612.10 |
| 183 | 04463747 | 10.2440.15 |
| 66 | 04464432 | 02.1612.00 |
| 66 | 04464433 | 02.1612.10 |
| 66 | 04464477 | 02.1609.00 |

CRUCE DE REFERENCIAS: REFERENCIAS ORIGINALES / AIR-FREN

CROSS REFERENCE LIST: ORIGINAL REFERENCES / AIR-FREN

| Pág. IVECO | AIR-FREN | Pág. IVECO | AIR-FREN | Pág. IVECO | AIR-FREN | Pág. IVECO | AIR-FREN | |
|------------|--------------------|---------------|----------|--------------------|----------------|---------------|--------------------|----------------|
| 66 | 04464483 | 02.1612.00 | 71 | 09986596 | 02.1609 | ** | 192322 | 01.4880 |
| 66 | 04464486 | 02.1612.10 | 71 | 09986597 | 02.1612 | ** | 192326 | 01.3701.15 |
| 66 | 04464487 | 02.1612.20 | 183 | 1001551 | 10.4375.10 | ** | 192327 | 01.5085 |
| 66 | 04464525 | 02.1612.20 | 178 | 1001552 Antigua | 10.055527 | ** | 192328 | 01.3701.08 |
| 66 | 04464585 | 02.1612.20 | 178 | 1001571 Antigua | 10.543002 | ** | 192329 | 01.4220 |
| ** | 04467411 | SV-1280 | 101 | 1001578 Antigua | 05.575537 | ** | 192330 | 01.4225 |
| 81 | 04468071 | 03.491102 | 125 | 1002514 | 07.3500.30 | ** | 192331 | 01.4215 |
| 81 | 04500822 | 03.491102 | ** | 109878 | 12.R391.001 | ** | 192332 | 01.3701.14 |
| 290 | 04670967 | 14.7031.00 | 182 | 1121692 Anulada | 10.4395.10 | ** | 192334 | 01.3701.04 |
| 129 | 04675513 | 08.4640.00 | 16 | 1173720 | 01.1200.25 | ** | 192335 | 01.R1150 |
| 93 | 04678080 | 04.4211.10 | 27 | 1173859 | 01.1200.135 | ** | 192336 | 3404 |
| 290 | 04695785 | 14.7031.00 | 16 | 1174474 | 01.1200.25 | 115 | 192349 | 06.R639008 |
| 121 | 04700994 | 07.561007 | 184 | 1260700 | 10.8210.00 | ** | 192418 | 01.3701.13 |
| 173 | 04712509 | 10.9640.00 | 71 | 1282538 | 02.1601 | 73 | 192734 | 02.2400.13 |
| 188 | 04712513 | 10.3200.50 | ** | 138142 | 230.371.02.077 | ** | 192740 | 02.192.740 |
| 66 | 04713104 | 02.1609.00 | ** | 140978 | 09.R140.978 | ** | 193263 | 2554 |
| 66 | 04713105 | 02.1612.00 | 211 | 172146 | 11.R100.00 | 102 | 194152 | 05.R645003 |
| 290 | 04719791 | 14.7031.00 | ** | 172146 | 11.R172.146 | 178 | 194356 | 10.R3350 |
| 66 | 04724488 | 02.1609.00 | 80 | 172654 Antigua | 03.R627001 | 82 | 194360 | 03.105508 |
| 163 | 04752910 | 10.410100 | 103 | 173050 | 05.R5090 | 212 | 194387 | 11.R3650 |
| 129 | 04756085 | 08.4640.00 | ** | 173055 | 11.R0136.1 | 169 | 194549 | 10.7060.00 |
| 66 | 04772380 | 02.1612.20 | 72 | 173064 | 02.2424.05 | 169 | 194584 | 10.6300.00 |
| 309 | 04774151 | 17.430.020 | ** | 173701 | 01.R173.701 | 196 | 194721 | 10.R2600 |
| 121 | 04775735 | 07.561007 | 106 | 173746 Antigua | 05.R633001 | 106 | 194850 Antigua | 05.R633001 |
| 121 | 04775736 | 07.561007 | 161 | 173773 | 10.R611005 | 212 | 194916 | 11.R2950 |
| 122 | 04775736 | 07.561011 | ** | 174185 | 342630550 | 212 | 194946 | 11.R3650 |
| 121 | 04775737 | 07.561007 | 211 | 174226 | 11.R100.00 | 123 | 195203 Antigua(1) | 07.R661001 |
| 122 | 04775737 | 07.561011 | ** | 174226 | 11.R174.226 | ** | 195211 | 11.R195.211 |
| 121 | 04775738 | 07.561007 | ** | 174767 | 1987434016 | 211 | 195211 | 11.R65.00 |
| 149 | 04776623 | 09.051.102 | 101 | 176314 Antigua | 05.R645013 | 74 | 19523801 | 02.1701.1 |
| 91 | 04782774 | 04.240.726.24 | 121 | 177334 | 07.R661004 | ** | 195239 | 238.024.01.008 |
| 121 | 04784409 | 07.561007 | 14 | 177979 | 01.1300.30 | 74 | 195240 | 02.1685.91 |
| 309 | 04787273 | 17.430.020 | 61 | 178054 | 01.R178.054 | ** | 195244 | 238.024.02.084 |
| 122 | 04804766 | 07.7020.70 | ** | 178618 | 01.178.618 | 115 | 195254 | 06.R639008 |
| 122 | 04823436 | 07.561011 | 138 | 179209 | 08.5857241 | 105 | 195264 Moderna | 05.R657002 |
| 121 | 04826204 | 07.561007 | 138 | 179334 | 08.R005000 | 74 | 195267 | 02.1831.91 |
| 122 | 04826204 | 07.561011 | ** | 179334 | 5002012 | 73 | 195270 | 02.3030.06 |
| 96 | 04841081 | 04.4224.50 | 73 | 179499 | 02.2424.06 | 72 | 195273 | 02.R9000N |
| 92 | 04841082 | 04.240.726.29 | 70 | 179790 Antigua | 02.1800.30 | 61 | 196052 | 01.R196.052 |
| 96 | 04841082 | 04.4234.00 | 277 | 179979 | 13.66046 | ** | 196214 | 01.R196.214 |
| 96 | 04841083 | 04.4234.00 | 73 | 190141 | 02.3000.13 | ** | 196215 | 01.R196.215 |
| 95 | 04841086 | 04.4219.00 | 183 | 190144 | 10.R8321 | ** | 196232 | 3080-M |
| 121 | 04842611 | 07.561007 | 124 | 190350 Moderna | 07.529001 | 242 | 197164 | 12.390.003 |
| 67 | 04845858 | 02.1216.30 | 61 | 190352 | 01.R192.164 | 178 | 197416 | 10.R430527 |
| 130 | 04853325 | 08.8010.40 | ** | 190445 | 14.190445 | 288 | 197456 | 14.2545.00 |
| 107 | 08122061 | 05.700000 | ** | 1907612 | 1987434016 | ** | 197683 | 197.694-05 |
| 163 | 08122107 | 10.410100 | 310 | 1908508 | 17.440.020 | 61 | 197694 | 01.R197694 |
| 71 | 08123746 | 02.1609 | 310 | 1908518 | 17.440.020 | 61 | 197695 | 01.R197695 |
| 172 | 08124283 | 10.R4730 | 310 | 1908524 | 17.440.020 | 129 | 197778 Antigua | 08.R464002 |
| 204 | 08124285 | 11.R2926 | 123 | 191810 Antigua(2) | 07.R661001 | 73 | 197941 | 02.03561409 |
| 145 | 08124364 | 09.R051.111 | 129 | 191985 Anulada | 08.R464002 | 303 | 198531 | 16.6590.00 |
| 149 | 08124410 | 09.R051.209 | ** | 192077 | 11.R2900 | 104 | 198557 Antigua | 05.557007 |
| 102 | 08137884 | 05.545023 | 61 | 192164 | 01.R192.164 | ** | 198558 | 11.R0546.6 |
| ** | 08160472 | 10.410112 | ** | 192278 | 192.278 | ** | 198715 | 01.391.103.4 |
| ** | 08160473 | 10.410112 | 184 | 192286 | 10.R8210 | 178 | 198735 | 10.R430527 |
| ** | 08160475 | 10.410112 | 93 | 192302 | 04.R631003 | 178 | 198739 | 10.R3350 |
| 104 | 08193547 | 05.2458.50 | ** | 192307 | 01.5360 | 129 | 198748 Moderna | 08.R464002 |
| 71 | 08197157 | 02.1612 | ** | 192308 | 01.3701.11 | ** | 198758 | 04.R565598 |
| ** | 098438178 | VG-3264 | ** | 192309 | 01.4235 | ** | 198762 | 04.R565597 |
| 181 | 09932419 | 10.R5210 | ** | 192311 | 5000175 | 90 | 198766 | 04.R631009 |
| 182 | 09932430 | 10.R1965 | ** | 192313 | 4335 | 101 | 198771 Moderna | 05.R645013 |
| 93 | 09934229 | 04.R4212 | ** | 192316 | 01.527.354 | 82 | 198979 | 03.105508 |
| 101 | 09982371 | 05.R645002 | ** | 192319 | 230.370.02.042 | 70 | 198992 | 02.1600.20 |
| ** | 09985312 | 11.R2928 | ** | 192320 | 1118 | 70 | 198993 Antigua | 02.1800.30 |
| 70 | 198994 | 02.9000.30 | 70 | 198995 | 02.1600.20 | 65 | 199001 | 02.239.020.1C |
| 16 | 199098 | 01.1300.10 | 16 | 199099 | 01.1300.10 | ** | 199106 | 01.199.106 |
| 16 | 199099 | 01.1300.10 | ** | 199099 | 01.1300.20 | 13 | 199521 | 01.391.300 |
| 54 | 199100 | 01.391.002 | ** | 199101 | 01.391.098 | ** | 199522 | 01.R1100E |
| ** | 199101 | 01.391.098 | ** | 199102 Antigua | 01.391.099 | 90 | 199546 | 04.R631009 |
| ** | 199102 Antigua | 01.391.099 | ** | 199106 | 01.199.106 | 16 | 199921 | 01.1300.10 |
| ** | 199106 | 01.199.106 | 13 | 199521 | 01.391.300 | ** | 199921 | 01.1300.20 |
| 178 | 213423 | 10.930.930 | ** | 199922 Antigua | 01.199.922 | 71 | 220407 | 02.1616L |
| 71 | 220407 | 02.1616L | 178 | 213423 | 10.930.930 | 176 | 222468 Antigua | 10.559003 |
| 176 | 222468 Antigua | 10.559003 | 71 | 220407 | 02.1616L | 129 | 222685 Moderna | 08.933.492 |
| 129 | 222685 Moderna | 08.933.492 | 101 | 222686 | Girar tapa 90° | 101 | 222686 | 05.545003 |
| 101 | 222686 | 05.545003 | 101 | 222692 | 05.545003 | 101 | 222692 | 05.545003 |
| 101 | 222692 | 05.545003 | 182 | 222693 | 10.2950.60 | 182 | 222694 Anulada | 10.4395.10 |
| 182 | 222693 | 10.2950.60 | 182 | 222694 Anulada | 10.4395.10 | 129 | 222703 | 08.222.703 |
| 182 | 222694 Anulada | 10.4395.10 | 129 | 222703 | 08.222.703 | 90 | 222709 | 04.565590 |
| 129 | 222703 | 08.222.703 | 90 | 222709 | 04.565590 | 90 | 222710 Girado pomo | 04.565590 |
| 90 | 222709 | 04.565590 | 90 | 222710 Girado pomo | 04.565590 | boca 22 tapón | 04.565590 | |
| 90 | 222710 Girado pomo | 04.565590 | 191 | 222721 Moderna | 10.579003 | 191 | 222721 Moderna | 10.579003 |
| 191 | 222721 Moderna | 10.579003 | 191 | 222722 Moderna | 10.579004 | 191 | 222722 Moderna | 10.579004 |
| 191 | 222722 Moderna | 10.579004 | 81 | 222724 Moderna | 03.491102 | 81 | 222724 Moderna | 03.491102 |
| 81 | 222724 Moderna | 03.491102 | 82 | 222763 Moderna | 03.105508 | 82 | 222763 Moderna | 03.105508 |
| 82 | 222763 Moderna | 03.105508 | 178 | 222764 | 10.930.930 | 178 | 222764 | 10.930.930 |
| 178 | 222764 | 10.930.930 | 181 | 222765 | 10.5210.10 | 181 | 222765 | 10.5210.10 |
| 181 | 222765 | 10.5210.10 | 90 | 222766 | 04.565590 | 90 | 222766 | 04.565590 |
| 90 | 222766 | 04.565590 | 176 | 222767 Moderna | 10.559001 | 176 | 222767 Moderna | 10.559001 |
| 176 | 222767 Moderna | 10.559001 | ** | 222785 | 04.R565597 | ** | 222785 | 04.R565597 |
| ** | 222785 | 04.R565597 | 178 | 222792 Antigua | 10.543002 | 178 | 222792 Antigua | 10.543002 |
| 178 | 222792 Antigua | 10.543002 | 105 | 222793 Moderna | 05.557004 | 105 | 222793 Moderna | 05.557004 |
| 105 | 222793 Moderna | 05.557004 | ** | 23037102011 | 01.527.354 | ** | 23037102011 | 01.527.354 |
| ** | 23037102011 | 01.527.354 | 93 | 2461044 | 04.4211.00 | 93 | 2461044 | 04.4211.00 |
| 93 | 2461044 | 04.4211.00 | 93 | 2461045 | 04.4211.00 | 93 | 2461045 | 04.4211.00 |
| 93 | 2461045 | 04.4211.00 | 179 | 2472250 | 10.543012 | 179 | 2472250 | 10.543012 |
| 179 | 2472250 | 10.543012 | 183 | 2486790 | 10.4375.10 | 183 | 2486790 | 10.4375.10 |
| 183 | 2486790 | 10.4375.10 | 129 | 2494161 | 08.222.703 | 129 | 2494161 | 08.222.703 |
| 129 | 2494161 | 08.222.703 | 93 | 2494473 Antigua | 04.4211.00 | 93 | 2494473 Antigua | 04.4211.00 |
| 93 | 2494473 Antigua | 04.4211.00 | 183 | 2506188 Moderna | 10.8321.00 | 183 | 2506188 Moderna | 10.8321.00 |
| 183 | 2506188 Moderna | 10.8321.00 | 206 | 250E21 | 11.R2942 | 206 | 250E21 | 11.R2942 |
| 206 | 250E21 | 11.R2942 | 182 | 2512412 | 10.2950.10 | 182 | 2512412 | 10.2950.10 |
| 182 | 2512412 | 10.2950.10 | 93 | 2515048 Moderna | 04.4212.00 | 93 | 2515048 Moderna | 04.4212.00 |
| 93 | 2515048 Moderna | 04.4212.00 | 176 | 2564591 Anulada | 10.559001 | 176 | 2564591 Anulada | 10.559001 |
| 176 | 2564591 Anulada | 10.559001 | 172 | 2606314 Anulada | 10.4720.00 | 172 | 2606314 Anulada | 10.4720.00 |
| 172 | 2606314 Anulada | 10.4720.00 | 172 | 2624688 Anulada | 10.4720.00 | 172 | 2624688 Anulada | 10.4720.00 |
| 172 | 2624688 Anulada | 10.4720.00 | 82 | 2965367 | 03.105508 | 82 | 2965367 | 03.105508 |
| 82 | 2965367 | 03.105508 | 173 | 2968407 Antigua | 10.0030.04 | 173 | 2968407 Antigua | 10.0030.04 |
| 173 | 2968407 Antigua | 10.0030.04 | 182 | 2968768 | 10.2950.40 | 182 | 2968768 | 10.2950.40 |
| 182 | 2968768 | 10.2950.40 | 123 | 2980732 Moderna(1) | 07.R661001 | 123 | 2980732 Moderna(1) | 07.R661001 |
| 123 | 2980732 Moderna(1) | 07.R661001 | 101 | 2980826 Anulada | 05.R645013 | 101 | 2980826 Anulada | 05.R645013 |
| 101 | 2980826 Anulada | 05.R645013 | 115 | 2980928 | 06.R639007 | 115 | 2980928 | 06.R639007 |
| 115 | 2980928 | 06.R639007 | 101 | 2981547 Moderna | 05.R645013 | 101 | 2981547 Moderna | 05.R645013 |
| 101 | 2981547 Moderna | 05.R645013 | 212 | 2981549 | 11.R3650 | 212 | 2981549 | 11.R3650 |
| 212 | 2981549 | 11.R3650 | 143 | 2982232 | 09.3100.00 | 143 | | |



| Pág. | IVECO | AIR-FREN |
|------|------------------|---------------|
| 82 | 2982457 | 03.105508 |
| 143 | 2991619 | 09.R3264 |
| 143 | 2992232 | 09.3100.00 |
| 143 | 2992237 | 09.R3000 |
| 161 | 2992261 | 10.1867.10 |
| 310 | 2992486 | 17.440.010 |
| 178 | 2995903 Anulada | 10.543002 |
| ** | 3072614214 | 12.R391.095 |
| ** | 3072616014 | 12.R391.003 |
| 123 | 317497 Antigua | 07.045522 |
| 191 | 33009409 | 10.3500.22R |
| 191 | 33009609 | 10.3500.22A |
| 289 | 3340501611 | 14.5000160 |
| 123 | 3435135 | 07.561003 |
| ** | 3922013363 | 12.R391.008 |
| ** | 3922024835 | 12.R391.009 |
| ** | 3922051435 | 12.R391.010 |
| ** | 3922081463 | 12.R391.012 |
| ** | 41000230 | 10.410112 |
| 195 | 41002217 | 10.432407.1 |
| 69 | 41015818 | 02.2424.70 |
| 173 | 41016830 Moderna | 10.4750.00 |
| ** | 41017240 | 10.410112 |
| 161 | 41017241 | 10.410104 |
| 195 | 41019442 | 10.432407 |
| 175 | 41022031 | 10.1883.75 |
| 175 | 41022032 | 10.1883.80 |
| 185 | 41027224 | 10.5018.00 |
| 285 | 41031725 | 14.21.500 |
| 96 | 41041178 | 04.4234.00 |
| ** | 41211121 | LP-4857 |
| ** | 41211339 | LP-4857 |
| ** | 41211340 | LK-4936 |
| ** | 41211392 | ZB-4593 |
| 123 | 41822432 | 07.561003 |
| 91 | 41822694 | 04.240.726.21 |
| 123 | 42001361 Moderna | 07.561003 |
| 309 | 42003396 | 17.430.010 |
| 309 | 42003397 | 17.430.010 |
| 310 | 42003473 | 17.440.015 |
| 310 | 42003474 | 17.440.015 |
| 310 | 42003658 | 17.440.015 |
| 309 | 42003823 | 17.430.030 |
| 309 | 42003834 | 17.430.030 |
| 66 | 42004534 | 02.1612.20 |
| 93 | 42017083 | 04.4211.10 |
| 96 | 42021811 | 04.4234.00 |
| 95 | 42021814 | 04.4219.00 |
| 96 | 42021929 | 04.4224.50 |
| 310 | 42026898 | 17.440.015 |
| 310 | 42026899 | 17.440.015 |
| 161 | 42029484 | 10.410103 |
| 69 | 42030595 | 02.1216.70 |
| 141 | 42037229 | 09.051.114 |
| 144 | 42037229 | 09.051.126 |
| 141 | 42037766 | 09.051.114 |
| 144 | 42037766 | 09.051.126 |
| 95 | 42041179 | 04.4219.00 |
| 69 | 42042131 | 02.1220.70 |
| 175 | 42042638 | 10.1883.75 |
| 66 | 42050131 | 02.1612.10 |
| 96 | 42050205 | 04.4234.00 |
| 66 | 42050617 | 02.1612.20 |
| 105 | 42051712 | 05.557001 |

| Pág. | IVECO | AIR-FREN |
|------|------------------|------------|
| 175 | 42052729 | 10.1883.75 |
| 67 | 42052855 | 02.1216.30 |
| 309 | 42061921 | 17.430.010 |
| 141 | 42061949 | 09.051.114 |
| 144 | 42061949 | 09.051.126 |
| 310 | 42063184 | 17.440.015 |
| 141 | 42063552 | 09.051.114 |
| 144 | 42063552 | 09.051.126 |
| 149 | 42064599 | 09.051.102 |
| ** | 42064755 | T-1417 |
| 185 | 42070065 | 10.5018.10 |
| 67 | 42071451 | 02.1216.30 |
| 97 | 42072435 | 04.4227.00 |
| 67 | 42072538 | 02.1216.30 |
| 115 | 42078368 | 06.559120 |
| 116 | 42078368 | 06.569110 |
| 97 | 42078570 | 04.4227.00 |
| 161 | 42079486 | 10.410103 |
| 115 | 42079915 | 06.559120 |
| 96 | 42081175 | 04.4224.50 |
| 115 | 42085657 | 06.559120 |
| 116 | 42085657 | 06.6050.60 |
| 115 | 42085658 | 06.559120 |
| 116 | 42085658 | 06.6050.60 |
| 121 | 42085760 | 07.561007 |
| 96 | 42087347 | 04.4224.50 |
| 130 | 42089956 | 08.3032.00 |
| 135 | 42089956 | 08.3111.00 |
| 106 | 42089958 Moderna | 05.533001 |
| 310 | 42102103 | 17.440.010 |
| 310 | 42102103 | 17.440.020 |
| ** | 42102583 | T-1416 |
| 310 | 42104476 | 17.440.010 |
| 310 | 42104476 | 17.440.020 |
| 183 | 42105552 | 10.3200.30 |
| 105 | 42106882 | 05.557001 |
| ** | 4211383 | ZB-4587 |
| 310 | 42114856 | 17.440.010 |
| 310 | 42114856 | 17.440.020 |
| ** | 42118426 | T-1416 |
| 195 | 42122263 | 10.432407 |
| 195 | 42122650 | 10.432407 |
| 185 | 42123220 | 10.5018.10 |
| 106 | 42125561 | 05.533005 |
| 66 | 42159113 | 02.1612.20 |
| 105 | 42480452 Moderna | 05.R657000 |
| 181 | 42481478 | 10.R5210 |
| 183 | 42483103 | 10.R8321 |
| 115 | 42483455 | 06.645.526 |
| 173 | 42483486 Moderna | 10.0030.04 |
| 172 | 42483694 | 10.R4720 |
| 204 | 42485192 | 11.R2925 |
| 96 | 42485349 | 04.R631008 |
| 90 | 42485350 | 04.R631009 |
| 105 | 42485996 Moderna | 05.R657002 |
| 105 | 42486484 | 05.R657001 |
| 172 | 42488941 | 10.R4730 |
| 178 | 42492090 | 10.R3350 |
| 204 | 42492909 | 11.R2926 |
| 116 | 42493355 | 06.R6040 |
| 115 | 42493396 | 06.R559120 |
| 107 | 42493406 | 05.R700403 |
| ** | 42493406 | 11.R2959 |
| ** | 42493406 | 11.R2959 |

| Pág. | IVECO | AIR-FREN |
|------|------------------------|--------------|
| 80 | 42493947 Moderna | 03.R627001 |
| 80 | 42498039 | 03.240.654.0 |
| 16 | 42522673 | 01.1200.25 |
| 219 | 42530032 | 12.360.085 |
| 219 | 42530033 | 12.360.070 |
| 220 | 42532082 | 12.360.090 |
| 59 | 42534245 + 42534247 | 01.R391.139 |
| 59 | 42534247 + 42534245 | 01.R391.139 |
| 57 | 42534533 | 01.391.1050 |
| 220 | 42535615 | 12.360.090 |
| 273 | 42536274 | 13.69462 |
| 273 | 42536275 | 13.69463 |
| 143 | 42537856 | 09.3000.00 |
| 323 | 42538002 | 18.R650.075 |
| 324 | 42541412 | 18.R750.030 |
| 324 | 42541413 | 18.R750.005 |
| 310 | 42543362 | 17.440.010 |
| 310 | 42556650 | 17.440.010 |
| 285 | 4459603 | 14.21.500 |
| 101 | 4691977 | 05.545003 |
| 183 | 4700564 Sustituida | 10.2440.15 |
| 183 | 4700995 Moderna | 10.2440.15 |
| 106 | 4746013 | 05.533005 |
| 172 | 4751117 | 10.4730.00 |
| 219 | 4752137 | 12.360.040 |
| 173 | 4752910 Antigua | 10.4750.00 |
| 106 | 4758659 | 05.533005 |
| 178 | 4759933 Moderna | 10.543002 |
| 106 | 4761396 | 05.533005 |
| 143 | 4761467 | 09.051.1071 |
| 143 | 4761467 | 09.3000.00 |
| 143 | 4761468 | 09.3000.00 |
| 106 | 4771456 | 05.533005 |
| 105 | 4773981 | 05.557001 |
| 105 | 4773986 | 05.557001 |
| 173 | 4779424 Moderna | 10.0030.02 |
| 80 | 4783981 | 03.527003 |
| 218 | 4813370 | 12.360.020 |
| 143 | 4814556 | 09.4400.00 |
| 106 | 4822162 | 05.533005 |
| 106 | 4824348 | 05.533005 |
| 218 | 4838676 | 12.360.030 |
| ** | 4842678 | 1186753 |
| ** | 500001621 | 01.391.103.3 |
| ** | 500001652 | 01.527.354 |
| ** | 500001673 Moderna | 01.391.099 |
| 195 | 500001720 | 10.975.303 |
| 182 | 500001975 | 10.2950.50 |
| 70 | 500001999 Moderna | 02.1800.00 |
| 121 | 500002009 | 07.7020.90 |
| 138 | 500002012 | 08.R005000 |
| 73 | 500002553 | 02.03561409 |
| 287 | 500002709 | 14.F.37 |
| ** | 500002710 | 10304 |
| ** | 500002734 | 10389 |
| ** | 500002738 | 21310 |
| ** | 500002903 | M002874 |
| ** | 500002908 | 10327 |
| ** | 500002909 | M002971 |
| ** | 500002956 | 500002956 |
| ** | 500002958 | 500002958 |
| ** | 500002959 | 31090901 |

| Pág. | IVECO | AIR-FREN |
|------|-------------------------|-----------------|
| ** | 500002979 | 500002979 |
| ** | 500002986 | 3120072210 |
| ** | 500002987 | 3120082210 |
| ** | 500003002 | 31094003 |
| ** | 500003006 | 3120462200 |
| ** | 500003013 | 31094901 |
| ** | 500003017 | 31090806 |
| ** | 500003020 | 31093501 |
| ** | 500003060 | 31090501 |
| 287 | 500003061 | 14.L.10C |
| 287 | 500003065 | 14.L.10L |
| 276 | 500003066 | 13.69112 |
| 106 | 500003067 | 05.712000 |
| 196 | 500003071 | 10.2458.48 |
| ** | 500003073 | EQSRERAO |
| 285 | 500003129 Moderna | 14.21.500 |
| 287 | 500003377 | 14.1.8C |
| ** | 500003401 | 9922402 |
| ** | 500003441 | 500003441 |
| ** | 500003751 | 500003751 |
| ** | 500003885 | 500003885 |
| 65 | 500004022 | 02.239.024.1 |
| 65 | 500004022 | 02.239.024.1C |
| 71 | 500004029 | 02.1802 |
| 304 | 500004272 | 16.6790.00 |
| 161 | 500004419 Moderna | 10.410102 |
| 102 | 500005264 | 05.R645003 |
| 178 | 500005292 Moderna | 10.055527 |
| 89 | 500005435 Antigua | 04.240.726.9 |
| 115 | 500005436 Antigua | 06.645.526 |
| 82 | 500005438 Antigua | 03.105508 |
| 115 | 500005444 | 06.539110 |
| 90 | 500005478 Moderna | 04.240.726.15 |
| 89 | 500005479 Moderna | 04.240.726.1 |
| 106 | 500005480 Moderna | 05.533001 |
| 89 | 500005514 | 04.240.726.0 |
| 123 | 500005515 Antigua | 07.045522 |
| 90 | 500005571 | 04.240.726.41.0 |
| ** | 500005574 | 3080-M |
| 65 | 500005585 | 02.239.020.1EE |
| 123 | 500005587 Moderna(2) | 07.R661001 |
| 242 | 500005599 | 12.391.076 |
| 241 | 500005600 | 12.391.091 |
| 82 | 500005610 Moderna | 03.105508 |
| ** | 500005631 | 500006649 |
| ** | 500005632 Antigua | 500006770 |
| 242 | 500005635 | 12.390.003 |
| 241 | 500005636 | 12.390.036 |
| ** | 500005688 | 547.235 |
| 178 | 500005696 | 10.R430527 |
| ** | 500005748 Moderna | 01.199.922 |
| 115 | 500005751 Moderna | 06.645.526 |
| 184 | 500005794 | 10.5676.00 |
| 14 | 500005804 | 01.772.938 |
| 123 | 500005822 Moderna | 07.045522 |
| ** | 500005823 | 01.1300.20 |
| 182 | 500005828 Moderna | 10.2950.75 |
| 104 | 500005829 Moderna | 05.557007 |
| 184 | 500005908 Moderna | 10.8210.00 |
| ** | 500005987 | 06.539120 |
| ** | 500006096 | 03.3050.00 |
| 73 | 500006146 | 02.3000.13 |
| 176 | 500006424 Moderna | 10.775.275 |

CRUCE DE REFERENCIAS: REFERENCIAS ORIGINALES / AIR FREN

CROSS REFERENCE LIST: ORIGINAL REFERENCES / AIR FREN

| Pág. IVECO | AIR-FREN | Pág. IVECO | AIR-FREN | Pág. IVECO | AIR-FREN | Pág. IVECO | AIR-FREN |
|-----------------------|--------------|--------------------|----------------|----------------------|-----------------|--------------------|---------------|
| ** 500006462 | 10.931.235 | 183 529451 | 10.3200.30 | ** 584622 | 1600-01 | ** 642035 | 12.R391.052 |
| ** 500006590 | 500006590 | ** 529451 | 10.3200.40 | 89 584624 | 04.R240.726.00 | ** 642655 | 10.244.315.0 |
| ** 500006649 | 500006649 | ** 546624 | 10.244.020.1 | 115 584625 Moderna | 06.R639007 | 182 642655 Antigua | 10.2950.20 |
| ** 500006672 | 02.192.740 | ** 546933 | 12.R391.021 | 182 584626 | 10.R1965 | 183 642657 Antigua | 10.2440.15 |
| 13 500006705 | 01.772.590 | ** 548018 | 12.R391.022 | ** 584760 | 400.402.5 | 178 642661 | 10.930.930 |
| 13 500006706 | 01.774.951 | 183 550081 | 10.4375.10 | ** 584769 | 238.024.02.003 | ** 642980 | 12.390.040 |
| 61 500006731 | 01.R178.054 | 196 550083 | 10.2550.00 | ** 584786 | 238.024.02.038 | ** 643008 | 01.643.008 |
| ** 500006739 | 12.390.040 | 89 551112 | 04.240.724.0 | 182 584826 | 10.R1965 | 70 643508 | 02.1600.20 |
| ** 500006770 Moderna | 500006770 | 75 55128501 | 02.1400.10 | 101 585010 Antigua | 05.R645002 | 81 64481801 | 03.491102 |
| 175 500006825 Moderna | 10.786.653 | 65 552260 | 02.239.012.1 | ** 585170 | 14.585170 | 81 644819 | 03.491102 |
| 70 500006826 Moderna | 02.R9000E | ** 556108 | 556.108 | 75 585450 | 02.R1400 | 115 645526 Antigua | 06.645.526 |
| 70 500006828 Moderna | 02.1800.30 | 124 556659 | 07.3600.00 | ** 585452 | 3800 | 105 645623 | 05.557004 |
| 82 500006829 Moderna | 03.R627003 | 76 557842 | 02.1302.1 | 198 585453 | 10.R3300 | 196 645784 | 10.2600.30 |
| 101 500006832 Moderna | 05.R645002 | 183 558480 | 10.4375.10 | 211 585454 | 11.R3750 | ** 646602 | 12.R391.055 |
| ** 500006854 | 500006854 | ** 559037 | 5000177 | ** 585455 | 11.R3200 | ** 646603 | 12.R391.056 |
| ** 500006858 | 500006858 | ** 559056 | 290.001.02.042 | 89 585456 | 04.R2400 | ** 647143 | 12.R391.062 |
| ** 500006927 | 500006927 | ** 559057 | 4103 | 196 585458 | 10.R2550 | ** 647144 | 12.R391.063 |
| 143 500006942 Moderna | 09.051.107P | ** 559058 | 4102 | 182 585459 | 10.R3450 | ** 647268 | 12.R391.064 |
| 144 500006943 | | ** 559059 | 4101 | ** 585580 | 238.024.02.038 | ** 647270 | 12.R391.065 |
| Sin muelle | 09.051.102P | ** 559083 | 5000203 | ** 585630 | 5550 | 242 647350 | 12.391.076 |
| 144 500006944 | | 198 559695 | 10.1950.10 | 198 585631 | 10.R1950 | ** 647352 | 12.R391.066 |
| Con muelle | 09.051.102P | ** 559854 | 03.3050.50 | 90 585796 | 04.240.726.01.0 | ** 647353 | 12.R391.098 |
| 143 500006945 | 09.R051.107 | 178 560370 Antigua | 10.543002 | 105 585836 Antigua | 05.R657000 | 243 647355 | 12.390.024 |
| 141 500006946 | 09.R051.114 | 182 560603 | 10.2950.40 | 285 586299 | 14.4315.1 | 243 647362 | 12.390.025 |
| ** 500006995 | 500006995 | ** 562261 | 01.562.261 | ** 587214 | 500005496 | 243 64736301 | 12.391.067 |
| ** 500007012 | 500007012 | ** 563373 | 5000294 | 178 587248 | 10.R3350 | 14 647447 | 01.772.956 |
| 101 500007020 | | ** 563382 | 03.3050.00 | 182 588214 | 10.2950.30 | 14 647531 | 01.772.951 |
| Girar tapa 90° | 05.545003 | ** 563383 | 03.3050.00 | 73 588443 | 02.2020.06 | 144 647690 | |
| 310 5000305439 | 17.440.010 | ** 563384 | 03.3050.00 | 90 588688 | 04.240.726.41.0 | Sin muelle | 09.051.102P |
| 310 5000305439 | 17.440.020 | ** 563589 | 04.240.724.4 | 212 588937 | 11.R2950 | 12 647721 | 01.3701.40 |
| 220 500300470 | 12.360.100 | 102 56598201 | 05.3300.44 | ** 588990 | 2019 | 14 647721 | 01.772.950 |
| 96 500303739 | 04.4236.00 | 65 567134 | 02.239.024.1 | ** 588997 | 11.R588.997 | ** 647763 | 647.763 |
| 310 500305439 | 17.440.010 | 102 567652 | 05.3300.34 | 211 588997 | 11.R65.00 | ** 647992 | 12.R391.069 |
| 310 500305439 | 17.440.020 | ** 568164 | 12.R391.097 | 72 589757 | 02.R589.757 | ** 648001 | 01.648.001 |
| ** 500310903 | ACX83D | 14 568840 | 01.568.840 | ** 589757 | 1600-01 | 14 648088 | 01.772.951 |
| 310 500317617 | 17.440.010 | ** 568841 | 01.568.841 | 70 589758 | 02.R1800M | 12 648335 | 01.3701.30 |
| 310 500317617 | 17.440.020 | ** 569690 | 10.3300.50 | 70 589759 Antigua | 02.R9000E | 12 648336 | 01.3701.20 |
| 310 500317671 | 17.440.010 | ** 569769 | 290.950.02.229 | 101 60147888 Moderna | 05.575537 | 12 648337 | 01.3701.40 |
| 310 500317671 | 17.440.020 | 62 570221 | 01.2460.20 | 183 60160709 | 10.3200.30 | 12 648338 | 01.3701.10 |
| 310 500335068 | 17.440.010 | 70 573398 | 02.9000.40 | 82 601786 | 03.105508 | 12 648339 | 01.3701.50 |
| 310 500335068 | 17.440.020 | 70 573433 | 02.1600.20 | 105 61577722 | 05.557004 | 242 648344 | 12.390.028 |
| 219 500350785 | 12.360.075 | 65 574346 | 02.239.024.1 | 290 61578002 | 14.7031.00 | ** 648346 | 12.R391.071 |
| 220 500350798 | 12.360.080 | ** 577766 | 12.R391.043 | 91 61594859 | 04.240.726.24 | ** 648347 | 12.R391.072 |
| 218 500361919 | 12.360.010 | ** 577767 | 12.R391.101 | 91 61595707 | 04.240.726.24 | ** 648348 | 12.R391.073 |
| 310 500397755 | 17.440.010 | ** 577772 | 12.R391.044 | ** 615984 | 5000273 | 242 648349 | 12.391.104 |
| 310 500397755 | 17.440.020 | ** 577832 | 12.R391.045 | 92 61598870 | 04.240.726.28 | ** 648350 | 12.391.074 |
| ** 502356 | 502.356 | ** 578142 | 12.R391.046 | ** 616507 | 02.1600.20E | ** 648354 | 12.R391.075 |
| 310 504120865 | 17.440.010 | ** 579236 | 12.R391.051 | 70 616508 | 02.1600.20 | 14 648381 | 01.772.951 |
| 71 513443 | 02.1601 | 90 57981001 | 04.240.726.12 | 169 623391 | 10.7060.00 | 12 648382 | 01.3701.60 |
| 184 513946 | 10.5676.00 | 71 580626 | 02.1802 | 70 625190 | 02.1800.00 | 242 648453 | 12.391.076 |
| 309 5160521610 | 17.430.030 | 71 580629 | 02.1651 | 70 625192 | 02.1800.00 | 182 690713 | 10.2950.50 |
| 14 523060 | 01.523.060 | 71 582024 | 02.1612 | 65 625199 | 02.239.024.1C | 101 692415 | 05.545003 |
| ** 523062 | 01.R173.701 | 71 582731 | 02.1601 | 65 625201 | 02.239.024.1C | 183 692436 | 10.3200.30 |
| ** 526387 | 500006053 | 71 582732 | 02.1651 | 184 631006 | 10.8210.00 | 191 695002 | 10.579003 |
| 198 526417 | 10.3300.10 | 74 582741 | 02.1805 | 310 632100420 | 17.440.015 | 191 695003 | 10.579004 |
| ** 526519 Antigua | 500006770 | 74 582742 | 02.9000.91 | ** 634677 | 110.011 | 89 695247 | 04.240.726.0 |
| ** 526762 | 12.R391.014 | 74 582791 | 02.1701.1 | ** 635762 | 12.R391.050 | 191 695945 | 10.579003 |
| ** 527248 | 500006649 | 72 582834 | 02.2020.05 | ** 635980 | 10.244.020.2 | 191 695946 | 10.579004 |
| ** 527349 | 01.527.349 | 71 583517 | 02.1802 | 65 637646 | 02.239.020.1EE | 178 696979 Antigua | 10.543002 |
| ** 527352 | 01.527.352 | 82 584539 Antigua | 03.R627003 | 65 637647 | 02.239.020.1EE | 176 697919 Antigua | 10.559001 |
| ** 527354 | 01.527.354 | 70 584619 | 02.R9000 | 65 640183 | 02.239.024.1 | 89 697931 | 04.240.726.17 |
| ** 527729 | 05.3750.00 | ** 584620 | 238.024.02.038 | ** 640677 | 12.R391.051 | 183 698809 Antigua | 10.8321.00 |
| 182 528409 Antigua | 10.4395.10 | 70 584621 | 02.R1800E | 182 641630 | 10.3450.10 | 182 699149 | 10.2950.50 |
| 89 529450 | 04.240.724.0 | 72 584622 | 02.R584.622 | 93 641865 Antigua | 04.4211.00 | 182 699149 Antigua | 10.2950.20 |



| Pág. | IVECO | AIR-FREN |
|------|------------------------|----------------|
| 182 | 699150 | 10.2950.60 |
| ** | 699151 | 10.244.315.2 |
| ** | 699766 | 3150-10 |
| 290 | 71021023 | 14.7031.00 |
| ** | 712908 | 3409274 |
| 70 | 716607 | 02.1800.00 |
| 70 | 716610 | 02.1800.00 |
| 70 | 716612 | 02.1800.00 |
| 285 | 716661 | 14.21.500 |
| ** | 716864 | 02.1600.20E |
| 70 | 717580 | 02.1800.00 |
| 70 | 717581 | 02.1800.00 |
| ** | 734232 | 02.1600.20E |
| ** | 734233 Moderna | 02.1600.20E |
| 115 | 735144 | 06.539110 |
| 90 | 736110 | 04.240.726.15 |
| 89 | 739233 | 04.240.726.9 |
| ** | 741317 | 10.244.020.2 |
| 70 | 743797 | 02.1600.20 |
| 81 | 745133 | 03.491102 |
| ** | 745449 | 14.745.449 |
| 14 | 746566 | 01.772.951 |
| 14 | 746567 | 01.772.951 |
| 12 | 746571 | 01.3701.90 |
| 65 | 750383 | 02.239.020.1EE |
| ** | 750734 | 5000285 |
| 101 | 753232 Antigua | 05.545003 |
| 176 | 754838 Antigua | 10.559001 |
| 81 | 757749 Antigua | 03.491102 |
| 105 | 757750 Antigua | 05.557001 |
| ** | 758500 | 10.758.500 |
| 90 | 76255800 | 04.240.726.14 |
| 89 | 76255901 Antigua | 04.240.726.1 |
| 181 | 763775 | 10.763.775 |
| ** | 763775 | 313130160 |
| 115 | 764985 | 06.539110 |
| 101 | 766141 | 05.545003 |
| 123 | 766255 Antigua | 07.045522 |
| 191 | 768245 | 10.3500.22A |
| 191 | 768246 | 10.3500.22R |
| 123 | 768991 Antigua | 07.045522 |
| 182 | 769206 | 10.2950.60 |
| 106 | 769207 Antigua | 05.533001 |
| 81 | 769869 | 03.491102 |
| 242 | 770131 | 12.390.031 |
| ** | 770133 | 12.R391.080 |
| ** | 770179 | 12.R391.081 |
| ** | 770181 | 12.R391.082 |
| 242 | 770182 | 12.390.032 |
| ** | 770249 | 12.R391.083 |
| 144 | 770803 Con muelle | 09.051.102P |
| 144 | 77085613 Sin muelle | 09.051.102P |
| ** | 771006 | 12.R391.084 |
| 13 | 771076 | 01.772.590 |
| ** | 771082 | 12.R391.085 |
| 243 | 77109813 | 12.390.034 |
| ** | 771813 | 12.R391.086 |
| ** | 771871 | 12.R391.087 |
| 241 | 771921 | 12.391.088 |
| 241 | 771937 | 12.390.036 |
| 16 | 772350 Tapa ciega | 01.1200.10 |

| Pág. | IVECO | AIR-FREN |
|------|-----------------|-------------|
| 13 | 772590 | 01.772.590 |
| 242 | 772598 | 12.391.089 |
| 174 | 772642 | 10.772.642 |
| 14 | 772938 | 01.772.938 |
| 14 | 772950 | 01.772.950 |
| 14 | 772951 | 01.772.951 |
| 14 | 772952 | 01.772.952 |
| 14 | 772956 | 01.772.956 |
| 285 | 773049 | 14.773.049 |
| 13 | 773136 | 01.774.951 |
| ** | 773137 | 12.R391.090 |
| ** | 773215 | 773.215 |
| 241 | 773242 | 12.390.036 |
| 241 | 773243 | 12.391.091 |
| 241 | 773244 | 12.391.091 |
| ** | 773526 | 773.526 |
| ** | 773736 | 12.R391.092 |
| ** | 774071 | 12.R391.093 |
| 241 | 774082 | 12.390.037 |
| 241 | 774083 | 12.390.038 |
| 13 | 774092 | 01.774.951 |
| 143 | 774479 Antigua | 09.051.107P |
| 13 | 774951 | 01.774.951 |
| 176 | 775275 Antigua | 10.775.275 |
| ** | 775589 | 12.R391.088 |
| 143 | 776026 Antigua | 09.051.107P |
| ** | 776611 | 12.R391.094 |
| 241 | 776719 | 12.390.039 |
| 241 | 776853 | 12.390.039 |
| 115 | 781132 | 06.539110 |
| 178 | 781133 Antigua | 10.543002 |
| 183 | 781134 | 10.3200.30 |
| 105 | 781135 | 05.557001 |
| 101 | 781553 | 05.545003 |
| 123 | 781697 Antigua | 07.045522 |
| 123 | 781698 Antigua | 07.045522 |
| 81 | 781704 | 03.491102 |
| 81 | 781705 | 03.491102 |
| ** | 781944 | 5002545 |
| 191 | 782637 | 10.3500.22R |
| 191 | 782638 | 10.3500.22A |
| 182 | 784794 A6 | 10.4395.10 |
| 101 | 785625 | 05.545003 |
| 175 | 786653 Antigua | 10.786.653 |
| 191 | 787717 | 10.579006 |
| 191 | 787718 | 10.579005 |
| 56 | 79035554 | 01.391.850 |
| 56 | 79035741 | 01.391.900 |
| 57 | 79098367 | 01.391.1050 |
| 121 | 795820 Antigua | 07.561001 |
| 161 | 795970 | 10.410102 |
| 161 | 796380 | 10.410106 |
| 121 | 796895 | 07.561002 |
| ** | 796895 | 500002009 |
| 191 | 797717 | 10.579006 |
| 191 | 797718 | 10.579005 |
| 175 | 7981576 | 10.1883.80 |
| 185 | 798741 | 10.511000 |
| 182 | 8120461 Moderna | 10.4395.10 |
| 173 | 8122107 Antigua | 10.4750.00 |
| 161 | 8123564 | 10.1867.10 |
| 105 | 8124000 Antigua | 05.R657002 |
| 122 | 8124167 | 07.R661003 |
| 181 | 8124173 | 10.R5310 |

| Pág. | IVECO | AIR-FREN |
|------|---------------------|---------------|
| 161 | 8124431 | 10.R611004 |
| 201 | 8124466 | 11.R2905 |
| 203 | 8124487 | 11.R2915 |
| 121 | 8124505 | 07.R661004 |
| 193 | 8124608 | 10.R4510 |
| 201 | 8124618 | 11.R2905 |
| 143 | 8124872 | 09.R051.107 |
| 143 | 8124908 | 09.3100.00 |
| 96 | 8137037 | 04.4236.00 |
| 161 | 8137622 | 10.410104 |
| 69 | 8137768 | 02.2424.70 |
| 161 | 8160470 | 10.410104 |
| 181 | 8166283 (9,5BAR) | 10.5310.80 |
| ** | 8167607 | SV-1416 |
| 182 | 8169973 | 10.2950.55 |
| 182 | 8169974 | 10.2950.55 |
| 132 | 8188642 | 08.8010.80 |
| ** | 8189440 | SV-1426 |
| 141 | 8190167 | 09.R051.114 |
| 143 | 8190746 | 09.3100.00 |
| 91 | 86015528 | 04.240.726.21 |
| 91 | 86015528 | 04.240.726.21 |
| 91 | 86015528 | 04.240.726.23 |
| ** | 901521 | 500001888 |
| 273 | 914265 | 13.62408 |
| 273 | 917982 | 13.62804 |
| ** | 931235 | 10.931.235 |
| 90 | 931277 | 04.565590 |
| 169 | 93159298 | 10.7060.00 |
| 94 | 93161152 | 04.R4214 |
| 56 | 93161485 | 01.391.950 |
| 57 | 93161594 | 01.391.1050 |
| 56 | 93161595 | 01.R391.129 |
| 193 | 931616 | 10.4115.00 |
| 143 | 93161724 | 09.R4500 |
| 143 | 93161725 | 09.3100.00 |
| 314 | 93161755 | 17.460.075 |
| 165 | 93161779 | 10.R611009 |
| 165 | 93161780 | 10.R611009 |
| 59 | 93161793 | 01.R391.134 |
| 129 | 93161823 | 08.R8015 |
| 161 | 93161833 | 10.R611005 |
| 57 | 93161841 | 01.391.1000 |
| 314 | 93161931 | 17.460.075 |
| 323 | 93162049 | 18.R650.070 |
| 322 | 93162050 | 18.R650.005 |
| 314 | 93162073 | 17.460.075 |
| 165 | 93162118 | 10.R611009 |
| 143 | 93162182 | 09.R3264 |
| 220 | 93190284 | 12.360.080 |
| 219 | 93190288 | 12.360.035 |
| 207 | 93190989 | 11.R2952 |
| 218 | 93191101 | 12.360.015 |
| ** | 932210 | 5002042 |
| 129 | 933492 Antigua | 08.933.492 |
| 129 | 933547 Antigua | 08.933.492 |
| 176 | 934516 Anulada | 10.559002 |
| 106 | 934854 Antigua | 05.533001 |
| 106 | 934918 | 05.712000 |
| 106 | 934957 Antigua | 05.533001 |
| 106 | 934958 Antigua | 05.533001 |
| 105 | 934959 | 05.557001 |
| 191 | 934961 | 10.579006 |

| Pág. | IVECO | AIR-FREN |
|------|------------------|------------|
| 191 | 934962 | 10.579005 |
| 115 | 935378 | 06.539110 |
| 115 | 935381 | 06.539110 |
| 67 | 966648 | 02.2024.00 |
| ** | 97496516 | 97496516 |
| 161 | 980829 | 10.410102 |
| 191 | 980890 | 10.579003 |
| 191 | 980891 | 10.579004 |
| 176 | 980892 Moderna | 10.559003 |
| 105 | 980893 | 05.557001 |
| 80 | 980896 | 03.527001 |
| 195 | 98404141 | 10.432407 |
| 218 | 98415831 | 12.360.025 |
| 143 | 98420498 | 09.4400.00 |
| 310 | 98436188 | 17.440.010 |
| 310 | 98436188 | 17.440.020 |
| 220 | 98439476 | 12.360.060 |
| 67 | 98446265 | 02.1216.30 |
| 219 | 98447661 | 12.360.055 |
| 218 | 98465322 | 12.360.020 |
| 131 | 98472878 | 08.4410.50 |
| 62 | 98492453 | 01.2590.05 |
| 220 | 98497115 | 12.360.065 |
| 218 | 98497117 | 12.360.020 |
| 288 | 9926058 | 14.2545.00 |
| 101 | 9931494 Antigua | 05.R645013 |
| 115 | 9932420 | 06.R639007 |
| 183 | 99432966 Moderna | 10.4375.10 |
| 178 | 99432975 Antigua | 10.543002 |
| 182 | 99432978 Antigua | 10.2950.75 |
| ** | 99436210 | VG-3361 |
| 218 | 99438900 | 12.360.010 |
| 220 | 99440728 | 12.360.095 |
| 137 | 99444042 | 08.005101 |
| 137 | 99444043 | 08.005102 |
| 219 | 99445447 | 12.360.075 |
| 219 | 99458098 | 12.360.045 |
| 219 | 99458099 | 12.360.050 |
| ** | 99471918 | LP-4857 |
| 183 | 99484322 | 10.4375.10 |
| 184 | 9985321 | 10.R8210 |
| 106 | 9989960 Moderna | 05.R633001 |
| 130 | IT4358 | 08.8010.40 |
| 143 | VG3288 | 09.4400.00 |

JOST

| Pág. | JOST | AIR-FREN |
|------|-------|------------|
| 282 | E200S | 14.8200.20 |
| 281 | E200T | 14.2400.20 |

JOSVAL

| Pág. | JOSVAL | AIR-FREN |
|------|-------------|----------------|
| 9 | 7301003 | 01.1100.90 |
| ** | 73037102077 | 230.371.02.077 |
| 70 | 7380249 | 02.1800.30 |
| 70 | 7380309 | 02.9000.30 |
| 80 | 7406540 | 03.240.654.0 |
| 80 | 74065401100 | 03.R2300E |
| ** | 76710001100 | 267.100.01.100 |
| ** | 83508121100 | 02.R1300E |

| Pág. | JOSVAL | AIR-FREN |
|------|-------------|--------------|
| 75 | 8351011 | 02.1350.20 |
| 75 | 8351250 | 02.1400.10 |
| 75 | 8351270 | 02.1400.10 |
| 76 | 83901602082 | 02.1302.1 |
| 65 | 8390200 | 02.239.020.1 |
| 104 | 8440082 | 05.557007 |
| 211 | 84400821100 | 11.R2750 |
| 211 | 84400831100 | 11.R2750 |
| 198 | 8446760 | 10.3300.10 |
| 103 | 8452334 | 05.605734 |
| 103 | 8452335 | 05.605733 |
| 9 | C75/35 | 01.1100.90 |
| 9 | C7535 | 01.1100.20 |
| 80 | VP52 | 03.240.654.0 |

KAESSBOHRER

| Pág. | KAESSBOHRER | AIR-FREN |
|------|-------------|------------|
| 313 | 0002507515 | 17.460.040 |
| 130 | 80251720000 | 08.3032.00 |
| 309 | 8383154000 | 17.430.020 |
| 309 | 8383189000 | 17.430.015 |
| 313 | 8383226185 | 17.460.040 |
| 313 | 8383248000 | 17.460.040 |
| 312 | 8383282000 | 17.460.015 |
| 157 | 8383345000 | 09.295.950 |
| 312 | A0012508815 | 17.460.015 |

KÍGEL

| Pág. | KÍGEL | AIR-FREN |
|------|--------|------------|
| 186 | 175308 | 10.5031.10 |
| 130 | 312470 | 08.8010.40 |
| 115 | 314028 | 06.559120 |
| 115 | 322797 | 06.559160 |
| 131 | 324727 | 08.4410.60 |
| 188 | 330595 | 10.3200.50 |
| 132 | 332419 | 08.8010.80 |
| 108 | 336489 | 05.557006 |
| 107 | 351000 | 05.714000 |
| 67 | 75683 | 02.3630.00 |
| 185 | 75826 | 10.5018.10 |
| 173 | 76161 | 10.9640.00 |
| 192 | 76622 | 10.579015 |
| 107 | 76934 | 05.714000 |
| 130 | 77414 | 08.3032.00 |
| 135 | 77414 | 08.3111.00 |
| 129 | 77415 | 08.933.492 |
| 191 | 79429 | 10.579013 |

KNORR

| Pág. | KNORR | AIR-FREN |
|------|---------------|---------------|
| 137 | 0500004201000 | 08.004201 |
| 93 | 065184301000 | 04.4211.10 |
| 91 | 1043130000 | 04.240.726.24 |
| 92 | 1043130000 | 04.240.726.28 |
| 33 | 1186722 | 01.1200.60 |
| ** | 1186722 | KZ433/1/5 |
| 65 | 1186754 | 02.6754.00 |
| 65 | 1186754XU | 02.6754.00 |

| Pág. | KNORR | AIR-FREN |
|------|------------------------------|------------|
| ** | 1194194 | LP-4857 |
| 178 | 1194339 | 10.543082 |
| 143 | 1420362 | 09.3000.00 |
| 143 | 1422149 | 09.3000.00 |
| 143 | 1422762 | 09.4400.00 |
| 143 | 1423079 | 09.3100.00 |
| 143 | 1424008 | 09.3100.00 |
| 143 | 1424371 | 09.4400.00 |
| 143 | 1426590 | 09.R4500 |
| 143 | 1426591 | 09.3100.00 |
| 71 | 234099K | 02.1601W |
| 71 | 234100K | 02.1802 |
| 71 | 234100K | 02.1802W |
| 71 | 234101K | 02.1651 |
| 71 | 234101K | 02.1651W |
| 71 | 234189K | 02.1616W |
| 71 | 234226K | 02.1612 |
| 71 | 234226K | 02.1612W |
| 71 | 234433K | 02.1609W |
| 71 | 2C72336 | 02.1601K |
| 71 | 2C72337 | 02.1802K |
| 71 | 2C72596 | 02.1616K |
| 93 | 65184340 | 04.4211.10 |
| 85 | 76620102 | 03.R527026 |
| 105 | AB2767 | 05.557004 |
| 105 | AB2795 | 05.557002 |
| 105 | AB2798 | 05.557001 |
| 105 | AB2802 | 05.557001 |
| 105 | AB2816 | 05.557001 |
| 105 | AB2831 | 05.557001 |
| 105 | AB2835 | 05.557001 |
| 105 | AB2840 | 05.009000 |
| 105 | AB2851 | 05.009000 |
| 121 | AC133A | 07.561007 |
| 121 | AC135AYK | 07.561007 |
| 121 | AC135AYZ | 07.561007 |
| 122 | AC135HY | 07.561011 |
| 122 | AC135HYK | 07.561011 |
| 122 | AC135HYZ | 07.561011 |
| ** | AC155D | AC155D |
| 181 | AC156A | 10.5310.80 |
| 181 | AC156C - Regulada 9,5 BAR | 10.5310.80 |
| 180 | AC157C | 10.5310.90 |
| ** | AC286A | AC286A |
| 105 | AC597A | 05.009010 |
| 105 | AC598A Con bocas M22 | 05.009010 |
| 173 | AE1103 | 10.9640.00 |
| 184 | AE1114 | 10.1881.10 |
| 176 | AE1201 | 10.559001 |
| 176 | AE1206 | 10.559001 |
| 176 | AE1207 | 10.559002 |
| 176 | AE1208 | 10.559003 |
| 182 | AE2100 | 10.4395.10 |
| 115 | AE4158 | 06.539110 |
| 116 | AE4158 | 06.6050.60 |
| 115 | AE4162 | 06.559110 |
| 116 | AE4162 | 06.569110 |
| 116 | AE4169 | 06.6050.60 |
| 116 | AE4170 | 06.6050.60 |
| 116 | AE4179 | 06.6050.60 |
| 116 | AE4183 | 06.569110 |
| 116 | AE4191 | 06.6050.60 |

| Pág. | KNORR | AIR-FREN |
|------|--------------------------------------|---------------|
| 104 | AE4200 | 05.2458.50 |
| 104 | AE4214 | 05.2458.51 |
| 103 | AE4215 | 05.2458.49 |
| 104 | AE4217 | 05.2458.50 |
| 104 | AE4232 | 05.2458.51 |
| 104 | AE4247 | 05.2458.50 |
| 104 | AE4257 | 05.2458.50 |
| 116 | AE4404 Todas bocas a M22X150 | 06.6050.60 |
| 116 | AE4422 | 06.559130 |
| 116 | AE4427 | 06.6050.60 |
| 116 | AE4428 | 06.6050.60 |
| ** | AE4428 | AE-4428 |
| 117 | AE4437 | 06.4437.00 |
| ** | AE4437 | AE-4437 |
| 116 | AE4439 | 06.6050.60 |
| ** | AE4439 | AE-4439 |
| 117 | AE4440 | 06.4440.00 |
| ** | AE4440 | AE-4440 |
| 116 | AE4447 | 06.6050.60 |
| 116 | AE4452 | 06.569110 |
| 117 | AE4502 | 06.4502.00 |
| ** | AE4502 | AE-4502 |
| 117 | AE4510 | 06.4510.00 |
| ** | AE4510 | AE-4510 |
| ** | AE4516 | AE-4516 |
| ** | AE4525 | AE-4525 |
| ** | AE4528 | AE-4528 |
| 116 | AE4604 | 06.579110 |
| ** | AE4604 | AE-4604 |
| 117 | AE4605 | 06.4605.00 |
| ** | AE4605 | AE-4605 |
| 116 | AE4610 | 06.6050.60 |
| ** | AE4625 | AE-4625 |
| 183 | AE5102 | 10.2440.15 |
| 104 | AS3000 | 05.557007 |
| 103 | AS3002 | 05.235546 |
| 102 | AS3011 | 05.9710.00 |
| 102 | AS3054 | 05.9710.00 |
| 108 | AS6101 | 05.557005 |
| 69 | BFM122B | 02.1220.70 |
| 69 | BFM181Y | 02.1824.70 |
| 103 | BR1305 | 05.605734 |
| 103 | BR1306 | 05.605733 |
| 106 | BR4411 | 05.533001 |
| 106 | BR4412 | 05.533001 |
| 106 | BR4414 | 05.533001 |
| 106 | BR4415 | 05.533005 |
| 106 | BR4429 Girar tapa 180° | 05.533001 |
| 106 | BR4442 | 05.533001 |
| 106 | BR4466 Con racores 16 --> 22 VOSS | 05.533001 |
| 106 | BR5504 | 05.715000 |
| ** | BR5504 | 475.715.507.0 |
| 107 | BR5522 | 05.700000 |
| 107 | BR5522 | 05.714000 |
| 185 | BR9131 | 10.5018.10 |
| 185 | BR9151 Con bocas Voss | 10.5018.00 |
| 185 | BR9152 | 10.5018.10 |
| 185 | BR9156 | 10.5018.00 |
| 186 | BR9200 | 10.5031.10 |
| 185 | BR9231 | 10.5040.10 |
| 186 | BR9232 | 10.5031.10 |

| Pág. | KNORR | AIR-FREN |
|------|-------------------------------|--------------|
| 185 | BR9233 | 10.5040.00 |
| 186 | BR9234 | 10.5031.00 |
| 66 | BS2500 | 02.239.024.6 |
| 66 | BS2503 | 02.239.024.6 |
| 66 | BS3251 | 02.239.014.6 |
| 66 | BS3352 | 02.239.018.6 |
| 66 | BS3361 | 02.239.016.6 |
| 66 | BS3404 | 02.239.020.6 |
| 66 | BS3451 | 02.239.022.6 |
| 66 | BS3452 | 02.239.022.6 |
| 66 | BS3453 | 02.239.022.6 |
| 66 | BS3509 | 02.239.024.6 |
| 66 | BS3536 | 02.239.024.6 |
| 66 | BS3601 | 02.239.030.6 |
| 69 | BS7304 | 02.1624.50 |
| 69 | BS7309 | 02.1624.50 |
| 69 | BS8307 | 02.1624.60 |
| 69 | BS8308 | 02.1624.60 |
| 69 | BS9259 | 02.1424.60 |
| 69 | BS9260 | 02.1424.60 |
| 69 | BS9261 | 02.1424.60 |
| 69 | BS9262 | 02.1424.60 |
| 69 | BS9263 | 02.1424.60 |
| 69 | BS9304 | 02.1624.60 |
| 69 | BS9397 | 02.1616.60 |
| 69 | BS9404 | 02.2024.60 |
| 69 | BS9434 + 2 Ref. 14.5001622 | 02.2024.60 |
| 69 | BS9504 | 02.2424.60 |
| 69 | BS9527 | 02.2430.60 |
| 65 | BX3402 | 02.239.020.1 |
| 65 | BX3416 | 02.239.020.1 |
| 65 | BX3417 | 02.239.020.1 |
| 65 | BX3507 | 02.239.024.1 |
| 65 | BX3530 | 02.239.024.1 |
| 65 | BX3534 | 02.239.024.1 |
| 65 | BX3535 | 02.239.024.1 |
| 65 | BX3602 | 02.239.030.1 |
| 65 | BX3604 | 02.239.030.1 |
| 65 | BX3605 | 02.239.030.1 |
| 65 | BX3630 | 02.239.030.1 |
| ** | BX7525 | 02.2430.85 |
| 68 | BX7528 | 02.2430.80 |
| 68 | BX7611 | 02.3030.80 |
| 67 | BX9402 | 02.2030.00 |
| 67 | BX9521 | 02.2430.00 |
| 66 | BY3202 | 02.1612.20 |
| 69 | BY7106 | 02.0916.90 |
| 69 | BY7203 | 02.1216.90 |
| 69 | BY7221 | 02.1220.70 |
| 69 | BY9260 | 02.1424.70 |
| 69 | BY9350 | 02.1824.70 |
| 69 | BY9451 | 02.2224.70 |
| 69 | BY9452 | 02.2224.70 |
| 69 | BY9500 | 02.2424.70 |
| 69 | BY9501 | 02.2424.70 |
| 75 | BZ1400 | 02.1350.20 |
| 75 | BZ1600 | 02.1400.10 |
| 75 | BZ1601 | 02.1400.10 |
| 66 | BZ3106 | 02.1609.00 |
| 66 | BZ3214 | 02.1612.20 |
| 66 | BZ3217 | 02.1612.00 |
| 66 | BZ3218 | 02.1612.10 |
| 66 | BZ3221 | 02.1612.20 |

| Pág. | KNORR | AIR-FREN | Pág. | KNORR | AIR-FREN | Pág. | KNORR | AIR-FREN | Pág. | KNORR | AIR-FREN |
|------|-------------------|---------------|------|-----------|---------------|------|-------------|-------------|------|--------|----------|
| 66 | BZ3224 | 02.1612.20 | 86 | DX95B | 03.527029 | ** | I87918 | I-87918 | 275 | KB1515 | 13.90022 |
| 65 | BZ3339 | 02.239.016.1 | 183 | EE1103 | 10.4375.10 | 201 | I87919 | 11.R2904 | 275 | KB1520 | 13.90023 |
| 65 | BZ3363 | 02.239.016.1 | 178 | EE4101 | 10.055527 | 201 | I90121 | 11.R2901 | 275 | KB1525 | 13.90024 |
| 65 | BZ3370 | 02.239.016.1 | 183 | EE4106 | 10.8321.10 | 37 | I90499 | 01.1300.60 | 275 | KB1535 | 13.90041 |
| 65 | BZ3465 | 02.239.020.1 | 183 | EE4206 | 10.8321.00 | ** | I90499 | LP-4813 | 261 | KB2010 | 13.62523 |
| 65 | BZ3664 | 02.239.030.1 | 66 | EF120F | 02.1612.20 | 145 | I90586 | 09.R3208 | 261 | KB2015 | 13.62524 |
| 70 | BZ6517 | 02.2080.00 | 93 | HB1135 | 04.4212.00 | 84 | I93189 | 03.527022 | 261 | KB2020 | 13.62538 |
| 70 | BZ6621 | 02.2070.00 | 93 | HB1140 | 04.4211.00 | 203 | I93262 | 11.R2916 | 261 | KB2025 | 13.62539 |
| 69 | BZ7114 | 02.0916.70 | 91 | HB1142 | 04.240.726.23 | 174 | I94326 | 10.1878.25 | 261 | KB2030 | 13.62197 |
| 69 | BZ7222 | 02.1220.70 | 93 | HB1144 | 04.4100.00 | ** | I99719 | MB-4849 | 261 | KB2035 | 13.62543 |
| 67 | BZ7311 | 02.1624.00 | 95 | HB1168 | 04.4228.00 | 81 | I99719008 | 03.R4849 | 265 | KB2040 | 13.62059 |
| 67 | BZ7352 Rosca M-22 | | 95 | HB1173 | 04.4220.00 | 206 | II14588008 | 11.R2939 | 265 | KB2045 | 13.60954 |
| | VOSS | 02.1624.00 | 93 | HB1176 | 04.4100.00 | 51 | II15615 | 01.1300.70 | 265 | KB2050 | 13.62594 |
| 67 | BZ7353 Rosca M-22 | | 95 | HB1179 | 04.4219.00 | ** | II15993 | LP-4825 | 265 | KB2055 | 13.62593 |
| | VOSS | 02.1624.00 | 96 | HB1180 | 04.4234.00 | 67 | II17128 | 02.1220.30 | 265 | KB2060 | 13.60953 |
| 67 | BZ7418 | 02.2030.00 | 96 | HB1191 | 04.4224.50 | 146 | II17767 | 09.R3262 | 265 | KB2065 | 13.60952 |
| 67 | BZ7419 | 02.2030.00 | 97 | HB1201 | 04.4225.00 | 146 | II17767008 | 09.R3262 | 263 | KB2070 | 13.62303 |
| 67 | BZ7443 | 02.2024.00 | 96 | HB1203 | 04.4224.00 | 67 | II18530 | 02.1624.30 | 263 | KB2075 | 13.62304 |
| 67 | BZ7530 | 02.2424.00 | 96 | HB1203 | 04.4224.50 | 67 | II19276 | 02.2030.30 | 263 | KB2080 | 13.62322 |
| 67 | BZ7580 | 02.2430.00 | 96 | HB1219 | 04.4222.00 | 322 | II30413/065 | 18.R650.005 | 263 | KB2090 | 13.62321 |
| 67 | BZ9324 Rosca M-22 | | 91 | HB1260 | 04.240.726.21 | 168 | II30654 | 10.410220 | 263 | KB2095 | 13.62320 |
| | VOSS | 02.1624.00 | 91 | HB1260 | 04.240.726.23 | 323 | II310370066 | 18.R650.080 | 265 | KB2100 | 13.60775 |
| 67 | BZ9406 | 02.2024.00 | 93 | HB1266 | 04.4100.00 | 145 | II31733 | 09.R3261 | 261 | KB2105 | 13.62542 |
| 67 | BZ9555 | 02.2724.00 | 91 | HB1358 | 04.240.726.22 | 145 | II31733008 | 09.R3261 | 261 | KB2110 | 13.62536 |
| 181 | DB1206 | 10.5310.80 | 94 | HB1510 | 04.4215.00 | 164 | II325810051 | 10.R611007 | 261 | KB2115 | 13.62525 |
| 180 | DB1234 (8 BAR) | 10.5310.90 | 147 | I141958 | 09.R3361 | 323 | II328090062 | 18.R650.070 | 261 | KB2120 | 13.62537 |
| 180 | DB1237 (8 BAR) | 10.5310.90 | 161 | I177934 | 10.1867.10 | 323 | II339680062 | 18.R650.070 | 261 | KB2125 | 13.62526 |
| 180 | DB1240 (8 BAR) | 10.5310.90 | 164 | I36251008 | 10.R611007 | 143 | II35696/008 | 09.R3264 | 265 | KB2130 | 13.62213 |
| 179 | DB2111 | 10.543012 | 173 | I60496 | 10.9640.00 | 67 | II35876 | 02.2024.30 | 265 | KB2150 | 13.62308 |
| 96 | DPM54A | 04.4234.00 | 123 | I61090 | 07.R920467 | 210 | II36011 | 11.R2969 | 265 | KB2155 | 13.62174 |
| 92 | DPM60A | 04.240.726.28 | 70 | I67587 | 02.R2070 | 210 | II36012 | 11.R2969 | 265 | KB2160 | 13.62173 |
| 96 | DPM84AX | 04.4234.00 | 202 | I67698 | 11.R2911 | 165 | II36248/008 | 10.R611009 | 269 | KB2210 | 13.62621 |
| 123 | DR3100 | 07.055522 | 202 | I68094 | 11.R2910 | 165 | II36249/008 | 10.R611009 | 269 | KB2215 | 13.62620 |
| 121 | DR3100 | 07.561007 | 70 | I69698 | 02.R2080 | 165 | II36250 | 10.R611009 | 269 | KB2220 | 13.62624 |
| 121 | DR3102 | 07.561007 | 133 | I69784 | 08.R8020 | ** | II36251/008 | 10.R9010 | 269 | KB2220 | 13.62660 |
| 123 | DR3200 | 07.015467 | 207 | I72290 | 11.R2944 | 38 | II37214 | 01.1200.90 | 267 | KB2225 | 13.62162 |
| 121 | DR3201 | 07.561007 | 93 | I72371 | 04.R4100 | ** | II37214 | LP-4974 | 267 | KB2230 | 13.62161 |
| 121 | DR3219 | 07.561007 | 85 | I72375 | 03.R527020 | 117 | II37680004 | 06.R4510 | 267 | KB2240 | 13.62160 |
| 123 | DR3223 | 07.065522 | 133 | I74651 | 08.R1280 | 117 | II376800051 | 06.R4510 | 267 | KB2245 | 13.62163 |
| 121 | DR3236 | 07.561007 | 207 | I76535 | 11.R2953 | 117 | II37680008 | 06.R4510 | 269 | KB2250 | 13.62622 |
| 121 | DR3238 | 07.561001 | 116 | I78183 | 06.R6040 | ** | II38716F004 | 01.5771 | 269 | KB2260 | 13.62625 |
| 121 | DR3500 | 07.561001 | 135 | I78448 | 08.R3111 | 161 | II39737F | 10.1867.50 | 269 | KB2260 | 13.62661 |
| 121 | DR3502 | 07.561002 | 133 | I80010 | 08.R1281 | 118 | II39746/004 | 06.R4528 | 271 | KB2275 | 13.62678 |
| 121 | DR3503 | 07.561009 | 83 | I80450 | 03.R527011 | 161 | II40100F | 10.1867.10 | 271 | KB2280 | 13.62782 |
| 123 | DR3515 | 07.3515.00 | 36 | I81015004 | 01.391.550 | 323 | K000375 | 18.R650.075 | 271 | KB2295 | 13.62726 |
| 121 | DR3515 | 07.561006 | 116 | I81171 | 06.R6050 | 324 | K000472 | 18.R750.030 | 271 | KB2300 | 13.62783 |
| 121 | DR3524 | 07.561007 | 202 | I81234 | 11.R2912 | 323 | K000696 | 18.R650.080 | 261 | KB2305 | 13.62540 |
| 121 | DR3537 | 07.561001 | 202 | I83842 | 11.R2907 | 322 | K000944 | 18.R650.005 | 269 | KB2360 | 13.62630 |
| 122 | DR3549 | 07.561010 | 205 | I84451008 | 11.R2937 | 324 | K001300 | 18.R750.005 | 261 | KB2400 | 13.62608 |
| 182 | DR4120 | 10.2950.50 | 145 | I84613 | 09.R3200 | ** | K007254 | ACX83D | 265 | KB2420 | 13.62596 |
| 182 | DR4123 | 10.2950.05 | 205 | I85063 | 11.R2932 | ** | K007254000 | ACX83D | 261 | KB2425 | 13.62609 |
| 182 | DR4125 | 10.2950.05 | 161 | I85127 | 10.1867.10 | 324 | K010603 | 18.R750.005 | 265 | KB2440 | 13.60706 |
| 182 | DR4125 | 10.2950.10 | 201 | I85139 | 11.R2902 | 322 | K010604 | 18.R650.005 | 265 | KB2445 | 13.60753 |
| 182 | DR4126 | 10.2950.10 | 203 | I85667 | 11.R2917 | ** | K011932 | AE-4516 | 261 | KB2515 | 13.62535 |
| 182 | DR4128 | 10.2950.60 | 133 | I85698 | 08.1295.00 | 276 | KB1000 | 13.62788 | 271 | KB2530 | 13.60921 |
| 182 | DR4130 | 10.2950.00 | 133 | I86534 | 08.R8025 | 276 | KB1005 | 13.62875 | 271 | KB2535 | 13.60922 |
| 182 | DR4301 | 10.2950.90 | 203 | I86741 | 11.R2917 | 276 | KB1010 | 13.62876 | 271 | KB2540 | 13.60923 |
| 182 | DR4340 | 10.2950.35 | 36 | I86909 | 01.1200.75 | 276 | KB1020 | 13.69022 | 271 | KB2545 | 13.60924 |
| 182 | DR4341 | 10.2950.90 | 36 | I86909 | 01.1300.55 | 276 | KB1025 | 13.69004 | 271 | KB2550 | 13.62673 |
| 182 | DR4350 | 10.2950.20 | ** | I86909 | LP-4812 | 276 | KB1030 | 13.69331 | 269 | KB2595 | 13.62631 |
| 182 | DR4352 | 10.2950.20 | 135 | I87465 | 08.R3115 | 276 | KB1075 | 13.62250 | 269 | KB2600 | 13.62469 |
| 182 | DR4354 | 10.2950.55 | 201 | I87917 | 11.R2903 | 275 | KB1500 | 13.90019 | 269 | KB2605 | 13.62468 |
| 85 | DX75BA | 03.527026 | 161 | I87918 | 10.R611011 | 275 | KB1505 | 13.90020 | 263 | KB2610 | 13.62012 |
| 86 | DX75BAY | 03.527028 | 201 | I87918 | 11.R2903 | 275 | KB1510 | 13.90021 | 263 | KB2615 | 13.62013 |

CRUCE DE REFERENCIAS: REFERENCIAS ORIGINALES / AIR FREN

CROSS REFERENCE LIST: ORIGINAL REFERENCES / AIR FREN

| Pág. | KNORR | AIR-FREN | Pág. | KNORR | AIR-FREN | Pág. | KNORR | AIR-FREN | Pág. | KNORR | AIR-FREN |
|------|--------|----------|----------------|--------------------|-------------|------|------------------------------|------------------------|------|----------------------------------|--------------|
| 263 | KB2620 | 13.60964 | 275 | KB6505 | 13.90001 | 161 | LA8211 | 10.410120 | ** | LP4985 Cambiando tubo culata | LP-4974 |
| 263 | KB2620 | 13.62508 | 275 | KB6510 | 13.90008 | 161 | LA8212 | 10.410121 | 80 | MB1201 | 03.240.654.0 |
| 263 | KB2625 | 13.60965 | 275 | KB6515 | 13.90009 | ** | LA8219 | LA-8219 | 79 | MB4419 | 03.1900.00 |
| 263 | KB2625 | 13.62509 | 275 | KB6520 | 13.90010 | 161 | LA8220 | 10.410104 | 79 | MB4434 | 03.1900.20 |
| 267 | KB2630 | 13.62813 | 275 | KB6525 | 13.90011 | ** | LA8220 | 10.410112 | 85 | MB4434 | 03.527020 |
| 267 | KB2635 | 13.62814 | 275 | KB6530 | 13.90012 | ** | LA8221 | LA-8221 | 79 | MB4477 | 03.1900.00 |
| 267 | KB2640 | 13.62835 | 275 | KB6535 | 13.90013 | ** | LA8221 | Sin calentador LA-8222 | 80 | MB4611 | 03.527003 |
| 267 | KB2645 | 13.62836 | 275 | KB6540 | 13.90014 | ** | LA8222 | LA-8222 | 80 | MB4630 | 03.527003 |
| 271 | KB2695 | 13.62672 | 275 | KB6545 | 13.90030 | 161 | LA8229 | 10.410103 | 83 | MB4630 | 03.527011 |
| 269 | KB2710 | 13.62654 | 191 | KU1310 | 10.579001 | 161 | LA8234 | 10.410102 | 80 | MB4636 | 03.527001 |
| 265 | KB2715 | 13.62211 | 191 | KU1311 | 10.579002 | ** | LA8234 | LA-8234 | 84 | MB4647 | 03.527016 |
| 265 | KB2720 | 13.62212 | 192 | KU1400 | 10.579016 | 161 | LA8284 | 10.410115 | 80 | MB4648 | 03.527003 |
| 269 | KB2735 | 13.69033 | 192 | KU1410 | 10.579017 | ** | LA8284 | LA-8206 | 80 | MB4650 | 03.527004 |
| 269 | KB2740 | 13.69034 | 191 | KU4124 | 10.579005 | ** | LA8286 | LA-8286 | 80 | MB4653 | 03.527003 |
| 265 | KB2750 | 13.62038 | 191 | KU4127 | 10.579013 | 163 | LA9000 | 10.410107 | 84 | MB4653 | 03.527023 |
| 265 | KB2755 | 13.62039 | 191 | KU4128 | 10.579006 | 163 | LA9001 | 10.410107 | 84 | MB4657 | 03.527021 |
| 265 | KB2765 | 13.60754 | 181 | KX17291 | 10.763.775 | 163 | LA9002 | 10.410127 | 84 | MB4661 | 03.527022 |
| 267 | KB2795 | 13.62318 | 181 | KX17292 | 10.763.775 | 163 | LA9003 | 10.410127 | 81 | MB4690 | 03.4849.00 |
| 267 | KB2800 | 13.62319 | 181 | KX17294 | 10.763.775 | 163 | LA9004 | 10.410107 | ** | MB4690 | MB-4849 |
| 267 | KB2815 | 13.62005 | ** | KY13961 | 0481008041 | 163 | LA9005 | 10.410107 | 85 | MB4694 | 03.527019 |
| 267 | KB2820 | 13.62006 | 50 | KZ1228/1 | 01.1200.150 | 163 | LA9007 | 10.410127 | 83 | MB4815 | 03.527013 |
| 265 | KB2855 | 13.62234 | 49 | KZ396/3 | 01.1200.145 | 163 | LA9008 | 10.410127 | 83 | MB4819 | 03.527013 |
| 267 | KB2905 | 13.62740 | 33 | KZ43315 | 01.1200.60 | 163 | LA9010 | 10.410107 | 83 | MB4820 | 03.527013 |
| 267 | KB2910 | 13.62741 | ** | KZ43315 | KZ433/1/5 | 164 | LA9010 | 10.9010.00 | 83 | MB4821 | 03.527013 |
| 267 | KB2920 | 13.62798 | ** | KZ4331RM | KZ433/1/5 | ** | LA9010 | LA-9010 | 83 | MB4836 Con pipeta descarga recta | 03.527013 |
| 267 | KB2920 | 13.69294 | 48 | KZ996/2 | 01.1200.140 | 163 | LA9011 | 10.410107 | ** | MB4847 | MB-4849 |
| 267 | KB2925 | 13.62799 | 48 | KZ996/2X50 | 01.1200.140 | 164 | LA9011 | 10.9010.00 | 81 | MB4849 | 03.4849.00 |
| 267 | KB2925 | 13.69295 | 193 | LA1100 | 10.1100.00 | ** | LK1300 | 01.1150.30 | ** | MB4849 | MB-4849 |
| 265 | KB2930 | 13.62809 | 178 | LA2100 | 10.930.930 | 31 | LK1527 | 01.1200.175 | 51 | OM4007 | 01.1300.70 |
| 265 | KB2990 | 13.62235 | 193 | LA4115 | 10.4115.00 | 27 | LK1900 | 01.1200.135 | 101 | RE1110 | 05.545003 |
| 267 | KB3040 | 13.69077 | 193 | LA4129 | 10.4115.00 | 17 | LK1901 | 01.1200.20 | 101 | RE1115 | 05.135517 |
| 267 | KB3045 | 13.69078 | 161 | LA6205 | 10.410103 | 16 | LK3904 | 01.1200.25 | 101 | RE1121 | 05.135517 |
| 267 | KB3050 | 13.69309 | 161 | LA6208 | 10.410104 | ** | LK4936 | LK-4936 | 101 | RE1129 | 05.545003 |
| 267 | KB3055 | 13.69308 | 161 | LA6209 | 10.410104 | 43 | LK4941 | 01.1200.165 | 178 | RE2108 | 10.543002 |
| 265 | KB3075 | 13.62616 | 161 | LA6210 | 10.410102 | 17 | LP1828 | 01.1200.15 | 178 | RE2111 | 10.543002 |
| 265 | KB3080 | 13.62617 | 161 | LA6221 | 10.410102 | 16 | LP1833 | 01.1200.25 | 101 | RE2221 | 05.575537 |
| 263 | KB3115 | 13.62987 | 161 | LA6222 | 10.410104 | 9 | LP1858 | 01.1100.20 | 36 | SEB00421 | 01.1300.55 |
| 263 | KB3120 | 13.62988 | 161 | LA6228 | 10.410111 | 10 | LP1961 | 01.1150.20 | 37 | SEB00551 | 01.1300.60 |
| 265 | KB3125 | 13.60772 | ** | LA6242 | 10.410112 | 27 | LP1974 | 01.1200.135 | 24 | SEB01000 | 01.391.1200 |
| 265 | KB3130 | 13.60771 | 161 | LA6700 | 10.410106 | 36 | LP4812 | 01.1200.75 | 38 | SEB01033004 | 01.391.650 |
| 271 | KB3135 | 13.62233 | 165 | LA6710 | 10.6710.00 | ** | LP4812 | LP-4812 | 24 | SEB01093/004 | 01.1300.110 |
| 271 | KB3140 | 13.62232 | ** | LA6710 | LA-6710 | ** | LP4813 | LP-4813 | 42 | SEB01444004 | 01.1300.135 |
| 265 | KB3155 | 13.62810 | 165 | LA6711 | 10.6711.00 | 45 | LP4814 | 01.1200.115 | 24 | SEB01782 | 01.1200.85 |
| 263 | KB3165 | 13.62578 | ** | LA6711 + 10.432407 | 10.410106 | 46 | LP4815 | 01.1200.120 | ** | SEB01782 | LP-4823 |
| 263 | KB3335 | 13.62456 | ** | LA6731 | 206092 | 24 | LP4823 | 01.1200.85 | 16 | SEB22062 | 01.R391.100 |
| 263 | KB3340 | 13.62455 | ** | LA6734 | LA-6734 | ** | LP4823 | LP-4823 | 54 | SEB22103 | 01.391.1100 |
| 263 | KB3400 | 13.62208 | ** | LA6735 | 206092 | 34 | LP4825 | 01.1200.65 | 206 | SEB22187 | 11.R2938 |
| 261 | KB3425 | 13.69024 | ** | LA8041 | LA-8041 | ** | LP4825 | LP-4825 | 206 | SEB22188 | 11.R2940 |
| 261 | KB3430 | 13.69025 | ** | LA8041 | LA-8065 | ** | LP4845 | LP-4845AT | 143 | SF30 | 09.3000.00 |
| 267 | KB3485 | 13.62997 | ** | LA8065 | LA-8041 | ** | LP4845 | LP-4845AT | 143 | SF44 | 09.4400.00 |
| 267 | KB3490 | 13.62998 | ** | LA8065 | LA-8065 | ** | LP4857 | LP-4857 | 59 | SK3040/1 + SK3043/1 | 01.R391.139 |
| 269 | KB3520 | 13.62478 | ** | LA8102 | LA-8125 | 38 | LP4930 | 01.1200.90 | 59 | SK3040/1 + SK3040/1 | 01.R391.139 |
| 269 | KB3520 | 13.62729 | ** | LA8105 | LA-8125 | ** | LP4930 | LP-4974 | 129 | SV1211 | 08.933.492 |
| 269 | KB3525 | 13.62730 | 165 | LA8125 | 10.8125.00 | 44 | LP4957 | 01.1200.210 | 133 | SV1257 | 08.1294.00 |
| 261 | KB3655 | 13.62544 | ** | LA8125 | LA-8125 | 42 | LP4964 | 01.1200.95 | 133 | SV1260 | 08.1260.00 |
| 261 | KB3660 | 13.62545 | 165 | LA8130 | 10.8130.00 | 43 | LP4965 | 01.1200.165 | ** | SV1274 | SV-1280 |
| 261 | KB3700 | 13.62704 | ** | LA8130 | LA-8130 | 39 | LP4967 | 01.1200.100 | 133 | SV1280 | 08.1280.00 |
| 261 | KB3705 | 13.62705 | 161 | LA8206 | 10.410114 | ** | LP4967 | LP-4967 | ** | SV1280 | SV-1280 |
| 265 | KB3815 | 13.62811 | ** | LA8206 | LA-8206 | 38 | LP4974 | 01.1200.90 | 133 | SV1281 | 08.1281.00 |
| 265 | KB3820 | 13.62812 | ** | LA8209 | LA-8209 | 40 | LP4985 | 01.1200.195 | 133 | SV1283 | 08.1295.00 |
| 271 | KB3910 | 13.69677 | 161 | LA8210 | 10.410114 | ** | LP4985 | LP-4985 | | | |
| 271 | KB3915 | 13.69678 | 161 | LA8210 Con calent. | | 38 | LP4985 Cambiando tubo culata | 01.1200.90 | | | |
| 275 | KB6500 | 13.90000 | Ref. 10.410205 | 10.410115 | | | | | | | |



| Pág. | KNORR | AIR-FREN |
|------|--------|------------|
| 129 | SV1287 | 08.222.703 |
| 136 | SV1288 | 08.1288.00 |
| 133 | SV1289 | 08.1294.00 |
| ** | SV1289 | SV-1294 |
| 133 | SV1290 | 08.1294.00 |
| ** | SV1290 | SV-1294 |
| 133 | SV1291 | 08.1294.00 |
| ** | SV1291 | SV-1294 |
| 133 | SV1292 | 08.1294.00 |
| ** | SV1292 | SV-1294 |
| 133 | SV1294 | 08.1294.00 |
| ** | SV1294 | SV-1294 |
| 133 | SV1295 | 08.1295.00 |
| ** | SV1295 | SV-1295 |
| ** | SV1303 | SV-1303 |
| 136 | SV1307 | 08.1307.00 |
| 129 | SV1307 | 08.933.492 |
| 133 | SV1310 | 08.1310.00 |
| ** | SV1310 | SV-1310 |
| 133 | SV1313 | 08.1313.00 |
| ** | SV1322 | SV-1329 |
| 134 | SV1323 | 08.1323.00 |
| ** | SV1323 | SV-1323 |
| ** | SV1325 | SV-1325 |
| ** | SV1329 | SV-1329 |
| ** | SV1330 | SV-1330 |
| 136 | SV1345 | 08.1345.00 |
| 134 | SV1350 | 08.1350.00 |
| ** | SV1350 | SV-1350 |
| 133 | SV1361 | 08.1361.00 |
| 133 | SV1362 | 08.1362.00 |
| 130 | SV1395 | 08.8010.40 |
| ** | SV1395 | SV-1395 |
| 135 | SV1399 | 08.1399.00 |
| ** | SV1399 | SV-1399 |
| 130 | SV1410 | 08.8010.50 |
| ** | SV1410 | SV-1410 |
| ** | SV1412 | 08.1412.00 |
| ** | SV1416 | SV-1416 |
| 129 | SV1418 | 08.933.492 |
| ** | SV1426 | SV-1426 |
| ** | SV1443 | SV-1443 |
| ** | SV1460 | SV-1460 |
| ** | SV1465 | SV-1465 |
| 135 | SV3111 | 08.3111.00 |
| ** | SV3111 | SV-3111 |
| 135 | SV3115 | 08.3115.00 |
| ** | SV3115 | SV-3115 |
| 169 | SV3302 | 10.3302.00 |
| 169 | SV3360 | 10.4600.40 |
| 169 | SV3367 | 10.7060.00 |
| 169 | SV3368 | 10.7060.00 |
| 169 | SV3371 | 10.3371.00 |
| 174 | SZ1114 | 10.285654 |
| 174 | SZ1115 | 10.265653 |
| 174 | SZ1124 | 10.1878.25 |
| 174 | SZ1130 | 10.1878.25 |
| 174 | SZ1159 | 10.275653 |
| 174 | SZ1161 | 10.285654 |
| 174 | SZ1166 | 10.1878.25 |
| 174 | SZ1190 | 10.1883.90 |
| 174 | SZ1200 | 10.1883.20 |
| 175 | SZ1208 | 10.1883.50 |
| 175 | SZ1300 | 10.1883.70 |

| Pág. | KNORR | AIR-FREN |
|------|--------|-------------|
| 145 | VG3200 | 09.051.111 |
| 145 | VG3200 | 09.3200.00 |
| 141 | VG3204 | 09.051.114 |
| 144 | VG3204 | 09.051.126 |
| 145 | VG3208 | 09.051.132 |
| 145 | VG3208 | 09.3208.00 |
| 145 | VG3208 | 09.3229.00 |
| ** | VG3229 | 09.051.157 |
| 145 | VG3229 | 09.3229.00 |
| ** | VG3229 | VG-3229 |
| 145 | VG3261 | 09.051.307 |
| 144 | VG3261 | 09.051.414 |
| 145 | VG3261 | 09.3261.00 |
| 144 | VG3261 | 09.625.436 |
| 146 | VG3262 | 09.3262.00 |
| ** | VG3262 | VG-3262 |
| 143 | VG3264 | 09.3264.00 |
| ** | VG3264 | VG-3264 |
| ** | VG3264 | VG-3288 |
| 143 | VG3269 | 09.3269.00 |
| ** | VG3269 | VG-3269 |
| ** | VG3288 | VG-3264 |
| ** | VG3288 | VG-3288 |
| ** | VG3289 | VG-3269 |
| ** | VG3289 | VG-3289 |
| 147 | VG3361 | 09.051.159 |
| 147 | VG3361 | 09.3361.00 |
| ** | VG3361 | VG-3361 |
| 115 | VPS41C | 06.559120 |
| 178 | VSR2A | 10.543002 |
| 290 | ZB1208 | 14.7031.00 |
| 195 | ZB3163 | 10.432407 |
| 54 | ZB4129 | 01.391.1100 |
| 16 | ZB4187 | 01.1300.10 |
| 16 | ZB4257 | 01.1300.10 |
| 16 | ZB4275 | 01.1300.10 |
| 52 | ZB4289 | 01.1300.150 |
| 163 | ZB4506 | 10.500200 |
| 163 | ZB4511 | 10.500100 |
| ** | ZB4511 | ZB-4511 |
| 163 | ZB4512 | 10.500100 |
| 166 | ZB4534 | 10.4535.00 |
| 163 | ZB4534 | 10.500100 |
| ** | ZB4534 | ZB-4534 |
| 166 | ZB4535 | 10.4535.00 |
| 163 | ZB4535 | 10.500100 |
| ** | ZB4535 | ZB-4534 |
| ** | ZB4567 | ZB-4587 |
| ** | ZB4578 | ZB-4578 |
| 166 | ZB4587 | 10.4587.00 |
| ** | ZB4587 | ZB-4587 |
| ** | ZB4593 | ZB-4593 |

KONGSBERG

| Pág. | KONGSBERG | AIR-FREN |
|------|-----------|-------------|
| 151 | 271194 | 09.R655.639 |
| 151 | 273447 | 09.R655.639 |
| 150 | 622095AM | 09.R655.435 |
| 150 | 622107AM | 09.360.717 |
| 150 | 622108AM | 09.371.612 |
| 150 | 622109AM | 09.360.717 |
| 150 | 622157AM | 09.R360.717 |

| Pág. | KONGSBERG | AIR-FREN |
|------|-----------|---------------|
| 149 | 622199AM | 09.1331.770 |
| 148 | 622206AM | 09.244.402 |
| 146 | 622402AM | 09.725.605 |
| 146 | 622427 | 09.R725.605 |
| 144 | 622500 | 09.051.414 |
| 141 | 622500 | 09.622.500 |
| 141 | 622501 | 09.622.500 |
| 151 | 622504AM | 09.622.504 |
| 141 | 622508 | 09.622.508 |
| 156 | 623104AM | 09.623.104 |
| 156 | 623105AM | 09.623.105 |
| 156 | 623106AM | 09.623.106 |
| 152 | 623109AM | 09.715.612 |
| 153 | 623157AM | 09.R358.801 |
| 152 | 623160AM | 09.715.611 |
| 150 | 624199 | 09.1337.966 |
| 156 | 624248AM | 09.624.248 |
| 153 | 624502AM | 09.358.801 |
| 153 | 624503AM | 09.361.136 |
| 141 | 625111 | 09.622.508 |
| 151 | 625218AM | 09.R622.504 |
| 149 | 625282AM | 09.R371.612 |
| 151 | 625290AM | 09.625.290 |
| 150 | 625359 | 09.625.359 |
| ** | 625375AM | 970.051.431.0 |
| 149 | 625384AM | 09.625.384 |
| 148 | 625385AM | 09.244.402 |
| ** | 625436 | 09.051.157 |
| 144 | 625436AM | 09.051.414 |
| 145 | 625436AM | 09.3261.00 |
| 144 | 625436AM | 09.625.436 |
| 151 | 625475AM | 09.R625.290 |
| 148 | 625524AM | 09.244.224 |
| 146 | 625586AM | 09.725.605 |
| 152 | 625976AM | 09.R715.611 |
| 152 | 625977AM | 09.R715.612 |
| 156 | 626159AM | 09.626.159 |
| 148 | 626162AM | 09.244.402 |
| 156 | 626163AM | 09.R626.159 |
| 156 | 626165AM | 09.R624.248 |
| 156 | 626243AM | 09.R623.106 |
| 151 | 626392AM | 09.655.639 |
| 141 | 626400 | 09.622.508 |
| 141 | 626580 | 09.622.508 |
| 150 | 626639AM | 09.655.435 |
| 151 | 626703AM | 09.R655.639 |
| 141 | 626708AM | 09.622.500 |
| 148 | 626729 | 09.R244.402 |
| 148 | 626731AM | 09.R245.752 |
| 148 | 626733 | 09.R244.224 |
| 149 | 626734 | 09.R627.612 |
| 154 | 626760 | 09.339.412 |
| 154 | 626761 | 09.265.209 |
| 152 | 626762AM | 09.348.735 |
| 152 | 626762AM | 09.R348.735 |
| 141 | 626783 | 09.622.508 |
| 141 | 626784 | 09.622.508 |
| 141 | 626785 | 09.622.500 |
| 141 | 626786AM | 09.622.500 |
| 141 | 626787 | 09.R622.508 |
| 141 | 626788AM | 09.R622.500 |
| 148 | 626853AM | 09.245.752 |
| 142 | 626869 | 09.628.447 |
| ** | 627052AM | 970.051.412.7 |

| Pág. | KONGSBERG | AIR-FREN |
|------|-----------|---------------|
| 154 | 627202 | 09.R265.209 |
| 151 | 627208 | 09.628.493 |
| 141 | 627579 | 09.628.448 |
| 142 | 627589AM | 09.628.449 |
| 149 | 627612AM | 09.627.612 |
| ** | 627612AM | 970.051.209.0 |
| 142 | 627667AM | 09.628.258 |
| 142 | 627668AM | 09.628.259 |
| 150 | 627692 | 09.625.359 |
| ** | 628027 | 09.051.157 |
| 144 | 628027AM | 09.625.436 |
| 142 | 628036AM | 09.628.036 |
| 150 | 628131 | 09.R625.359 |
| 142 | 628258AM | 09.628.258 |
| 142 | 628259AM | 09.628.259 |
| 142 | 628260AM | 09.628.260 |
| 141 | 628275 | 09.622.508 |
| 141 | 628276 | 09.622.500 |
| 141 | 628277 | 09.622.500 |
| 142 | 628305 | 09.R628.260 |
| 142 | 628447 | 09.628.447 |
| 141 | 628448AM | 09.628.448 |
| 142 | 628449AM | 09.628.449 |
| 141 | 628450 | 09.622.508 |
| 151 | 628476 | 09.R628.492 |
| 151 | 628492 | 09.628.492 |
| 151 | 628493 | 09.628.493 |
| 151 | 628494AM | 09.628.494 |
| 150 | 629683 | 09.625.359 |
| ** | 630361AM | 970.051.412.7 |
| 150 | 702603 | 09.371.612 |

KRONE

| Pág. | KRONE | AIR-FREN |
|------|----------|------------|
| 186 | 58065270 | 10.5031.10 |
| 175 | 5808176 | 10.1883.40 |
| 131 | 5810493 | 08.4410.60 |
| 131 | 58104930 | 08.4410.60 |
| 108 | 58111590 | 05.557006 |
| 185 | 5815328 | 10.5040.00 |
| 187 | 5815329 | 10.4494.20 |
| 187 | 5815672 | 10.4494.10 |
| 192 | 5820328 | 10.579016 |
| 192 | 5820329 | 10.579017 |
| 107 | 945013 | 05.714000 |
| 107 | 945015 | 05.700000 |
| 130 | 945035 | 08.8010.40 |
| 129 | 945035 | 08.933.492 |
| 130 | 9450351 | 08.8010.40 |
| 130 | 945047 | 08.3032.00 |
| 135 | 945047 | 08.3111.00 |
| 130 | 9450471 | 08.3032.00 |
| 135 | 9450471 | 08.3111.00 |
| 173 | 945142 | 10.9640.00 |
| 129 | 945143 | 08.933.492 |
| 129 | 9451430 | 08.933.492 |
| 192 | 945403 | 10.579015 |
| 121 | 9454311 | 07.561007 |

LAC

| Pág. LAC | AIR-FREN |
|-----------|--------------|
| 80 LAC105 | 03.240.654.0 |
| 80 LAC137 | 03.527001 |

LECIÑENA

| Pág. LECIÑENA | AIR-FREN |
|----------------|--------------|
| ** 3110038000 | 31095506 |
| ** 3110072202 | 31090901 |
| ** 3120072210 | 3120072210 |
| ** 3120082210 | 3120082210 |
| 304 3120470000 | 16.6790.00 |
| 285 3122040000 | 14.21.500 |
| 191 3140050000 | 10.3500.22R |
| 191 3140060000 | 10.3500.22A |
| 62 3141010000 | 01.2760.40 |
| 62 3141020000 | 01.2760.60 |
| ** 4110810000 | 31090501 |
| 276 4120060000 | 13.69112 |
| 287 412130 | 14.L.10C |
| 287 412132 | 14.L.10L |
| 191 4140010000 | 10.579010 |
| 191 4140020000 | 10.579009 |
| 106 4140040000 | 05.712000 |
| 66 4140060000 | 02.239.016.6 |
| 66 4140070000 | 02.239.020.6 |
| 65 4140080000 | 02.239.024.1 |
| 65 4140090000 | 02.239.030.1 |
| 68 4140100000 | 02.2430.80 |
| 68 4140110000 | 02.3030.80 |
| 183 4140200000 | 10.2440.15 |
| 178 4140280000 | 10.930.930 |
| 130 4140350000 | 08.8010.50 |
| 69 4140540000 | 02.1616.60 |
| 69 4140560000 | 02.2024.60 |

LECITRAILER

| Pág. LECITRAILER | AIR-FREN |
|------------------|--------------|
| 66 06800114 | 02.239.036.2 |
| 178 4110181 | 10.930.930 |
| 103 4110191 | 05.235546 |
| 130 4110201 | 08.8010.40 |
| 191 4110221 | 10.579001 |
| 191 4110231 | 10.579002 |
| 182 4110251 | 10.2950.90 |
| 130 4110261 | 08.8010.50 |
| 183 4110271 | 10.2440.15 |
| 106 4110301 | 05.712000 |
| 103 4110321 | 05.235546 |
| 178 4110341 | 10.543002 |
| 183 4110351 | 10.3200.30 |
| 191 4110421 | 10.579005 |
| 191 4110431 | 10.579006 |
| 182 4110491 | 10.4395.10 |
| 182 4110531 | 10.2950.15 |
| 68 4110541 | 02.2430.80 |
| 103 4110641 | 05.605733 |
| ** 4110641 | 11.R0546.6 |
| 103 4110651 | 05.R645010 |
| 66 4110711 | 02.239.016.6 |

Pág. LECITRAILER AIR-FREN

| | |
|-------------|--------------|
| 69 4110721 | 02.1616.60 |
| 191 4110740 | 10.579003 |
| 191 4110750 | 10.579004 |
| 101 4110760 | 05.545003 |
| 285 4110770 | 14.4315.1 |
| 106 4110820 | 05.R715000 |
| 103 4111141 | 05.2458.49 |
| ** 4120031 | SV-1410 |
| ** 4120311 | SV-1395 |
| 66 4120351 | 02.239.020.6 |
| 69 4120371 | 02.2024.60 |
| 196 4190221 | 10.2458.48 |
| 69 4190800 | 02.1624.50 |
| 69 4190810 | 02.1624.50 |
| 276 5800139 | 13.62875 |
| 276 5800140 | 13.62876 |
| 276 5820048 | 13.62788 |
| 276 5820084 | 13.808 |
| ** 5820087 | 5820087 |
| 177 6280101 | 10.8400.00 |
| 285 8010090 | 14.21.500 |

LEYLAND

| Pág. LEYLAND | AIR-FREN |
|--------------|---------------|
| 151 1291857 | 09.R622.504 |
| 309 1362752 | 17.430.035 |
| 91 15528 | 04.240.726.21 |
| 193 641072 | 10.4510.00 |
| 80 68409 | 03.527003 |
| 290 709671 | 14.7031.00 |
| 309 ACHL257 | 17.430.010 |
| 151 ACU8944 | 09.622.504 |
| 151 AXU0132 | 09.625.290 |
| 80 BBU 6441 | 03.527003 |
| 173 BBU4854 | 10.4750.00 |
| 82 BBU5391 | 03.105508 |
| 82 BBU5394 | 03.3070.10 |
| 80 BBU6440 | 03.527004 |
| 67 BBU9381 | 02.2020.00 |
| 129 FBU3129 | 08.933.492 |
| 130 FBU3132 | 08.3032.00 |
| 135 FBU3132 | 08.3111.00 |
| 107 FBU3135 | 05.700000 |
| 209 FBU5896 | 11.R2962 |
| 151 FBU9623 | 09.R625.290 |
| 115 MBU5184 | 06.559120 |
| 311 X4155253 | 17.450.030 |

LIEBHERR

| Pág. LIEBHERR | AIR-FREN |
|----------------|---------------|
| 91 5026206 | 04.240.726.21 |
| 177 5026483 | 10.559007 |
| ** 502649408 | 10.R3200E |
| 95 5026500 | 04.4219.00 |
| 195 502657108N | 10.432407 |
| 195 502661608 | 10.432407.1 |
| 80 5029 929 | 03.527003 |
| 80 5029 929 R | 03.527003 |
| 130 502918101 | 08.3032.00 |
| 135 502918101 | 08.3111.00 |

Pág. LIEBHERR AIR-FREN

| | |
|---------------|---------------|
| 193 5029210 | 10.1100.00 |
| 193 502921008 | 10.1100.00 |
| 186 502922901 | 10.5031.10 |
| 175 5029315 | 10.1883.70 |
| 91 502938408 | 04.240.726.23 |
| 191 5029665 | 10.579013 |
| 191 502966508 | 10.579013 |
| 181 502992408 | 10.R5210 |
| 82 502993408 | 03.105508 |
| 309 5030108 | 17.430.020 |
| 309 5030166 | 17.430.015 |
| 309 503118408 | 17.430.035 |
| 309 5031325 | 17.430.020 |
| 309 503132508 | 17.430.020 |
| 90 570319008 | 04.R631009 |

MAGIRUS

| Pág. MAGIRUS | AIR-FREN |
|----------------|------------|
| 309 01261558 | 17.430.020 |
| 309 01398598 | 17.430.020 |
| 309 02440924 | 17.430.030 |
| 309 02443133 | 17.430.015 |
| 309 02475546 | 17.430.010 |
| 309 02475547 | 17.430.010 |
| 309 02475629 | 17.430.015 |
| 309 02479048 | 17.430.015 |
| 309 02565803 | 17.430.010 |
| 309 03428017 | 17.430.030 |
| 309 04774151 | 17.430.020 |
| 309 04787273 | 17.430.020 |
| 16 11737520 | 01.1200.25 |
| 17 1173860 | 01.1200.20 |
| 309 42003396 | 17.430.010 |
| 309 42003397 | 17.430.010 |
| 309 42003473 | 17.430.015 |
| 309 42003474 | 17.430.015 |
| 309 42003658 | 17.430.015 |
| 309 42003823 | 17.430.030 |
| 309 42003834 | 17.430.030 |
| 309 42026898 | 17.430.015 |
| 309 42026899 | 17.430.015 |
| 309 42061921 | 17.430.010 |
| 309 42063184 | 17.430.015 |
| 309 5160521610 | 17.430.030 |
| 202 8124576 | 11.R2914 |

MAGNETI MARELLI

| Pág. MAGNETI MARELLI | AIR-FREN |
|----------------------|-------------|
| 178 1111521000 | 10.543002 |
| 56 76618101 | 01.391.950 |
| 57 76622602 | 01.391.1050 |
| 56 76623101 | 01.391.900 |
| 57 76629802 | 01.391.1000 |
| 56 76699701 | 01.391.850 |
| 104 AC286A | 05.2458.50 |
| 104 AC555AK | 05.557007 |
| 104 AC555AKES | 05.557007 |
| 101 AC574AX | 05.545004 |

Pág. MAGNETI MARELLI AIR-FREN

| | | |
|----------------------------|-------------|------------|
| 101 AC574AXY C/ Silencioso | 10.432407.1 | 05.545004 |
| 101 AC574AY | | 05.545004 |
| 101 AC574BYW C/Silencioso | 10.432407 | 05.545004 |
| 290 AC784D | | 14.7031.00 |
| 101 ACX586AAX | | 05.575537 |
| ** AL571AX | | 295.0711.0 |
| 93 DPM42A | | 04.4212.00 |
| 93 DPM43A | | 04.4211.10 |
| 93 DPM43CA | | 04.4211.10 |
| 96 DPM52AK | | 04.4224.50 |
| 96 DPM81BA | | 04.4224.00 |
| 95 DPM85AK | | 04.4219.00 |
| 96 DPM94AAX | | 04.4236.00 |
| ** DPM95AAX | | 04.4237.00 |
| 80 DX70A | | 03.527001 |
| 80 DX70C | | 03.527001 |
| 80 DX70CRM | | 03.527001 |
| 80 DX81A | | 03.527001 |
| 173 EDP25A | | 10.4750.00 |
| 173 EDP25AA | | 10.4750.00 |
| 173 EDP25AA1 | | 10.4750.00 |
| 66 EF120AB | | 02.1612.00 |
| 116 VPS45A | | 06.559130 |
| 116 VPS48A | | 06.6050.60 |

MAN

| Pág. MAN | AIR-FREN |
|-----------------|-------------|
| 157 0005863529 | 09.R715.607 |
| 310 36305500001 | 17.440.010 |
| 223 51065006228 | 12.370.025 |
| 223 51065006282 | 12.370.030 |
| 223 51065006302 | 12.370.010 |
| 223 51065006374 | 12.370.010 |
| 223 51065006394 | 12.370.010 |
| 224 51065006408 | 12.370.035 |
| 223 51065006416 | 12.370.010 |
| 223 51065006423 | 12.370.010 |
| 224 51065006426 | 12.370.045 |
| 225 51065006457 | 12.370.065 |
| 223 51065006476 | 12.370.015 |
| 224 51065006479 | 12.370.040 |
| 224 51065006480 | 12.370.060 |
| 224 51065006492 | 12.370.050 |
| 223 51065006495 | 12.370.020 |
| 226 51065006515 | 12.370.095 |
| 226 51065006537 | 12.370.090 |
| 224 51065006543 | 12.370.055 |
| 225 51065006545 | 12.370.070 |
| 225 51065006546 | 12.370.075 |
| 225 51065006547 | 12.370.080 |
| 225 51065006548 | 12.370.085 |
| 226 51065006575 | 12.370.105 |
| 226 51065006606 | 12.370.105 |
| 226 51065007033 | 12.370.100 |
| 226 51065007036 | 12.370.100 |
| 226 51065007045 | 12.370.100 |
| 226 51065007047 | 12.370.100 |
| 226 51065007048 | 12.370.100 |
| 226 51065007065 | 12.370.100 |



| Pág. | MAN | AIR-FREN | Pág. | MAN | AIR-FREN | Pág. | MAN | AIR-FREN | Pág. | MAN | AIR-FREN |
|------|---------------------|-------------|------|-------------|-------------|------|-------------|---------------|------|-------------|------------|
| 226 | 51065007066 | 12.370.100 | 311 | 81300006336 | 17.450.025 | ** | 81307256049 | VG-3262 | 70 | 81504106117 | 02.2080.00 |
| 226 | 51065009048 | 12.370.100 | 309 | 81300006587 | 17.430.035 | 146 | 81307256051 | 09.725.605 | 70 | 81504106118 | 02.2070.00 |
| 226 | 51065009052 | 12.370.100 | 309 | 81300006600 | 17.430.035 | ** | 81307256053 | 09.051.157 | 70 | 81504106120 | 02.2080.00 |
| 226 | 51065009066 Actual | 12.370.100 | 314 | 81303006002 | 17.460.075 | 145 | 81307256053 | 09.051.307 | 70 | 81504106124 | 02.2080.00 |
| 223 | 51065009228 | | 314 | 81303006003 | 17.460.075 | 146 | 81307256053 | 09.725.605 | 70 | 81504106125 | 02.2070.00 |
| | Reacondicionada | 12.370.025 | 309 | 81305500026 | 17.430.030 | ** | 81307256053 | VG-3229 | 70 | 81504106160 | 02.2070.00 |
| 223 | 51065009282 | | 311 | 81305500035 | 17.450.035 | ** | 81307256054 | 09.051.157 | 67 | 81504106197 | 02.2430.00 |
| | Reacondicionada | 12.370.030 | 309 | 81305500041 | 17.430.020 | 149 | 81307256059 | 09.R051.209 | 67 | 81504106214 | 02.2430.00 |
| 224 | 51065009408 | | 311 | 81305500043 | 17.450.025 | 146 | 81307256061 | 09.R725.605 | 70 | 81504106217 | 02.2070.00 |
| | Reacondicionada | 12.370.035 | 309 | 81305500044 | 17.430.010 | 145 | 81307256064 | 09.051.307 | 67 | 81504106565 | 02.1616.00 |
| 223 | 51065009423 | | 311 | 81305500049 | 17.450.035 | ** | 81307256064 | VG-3261 | 67 | 81504109197 | 02.2430.00 |
| | Reacondicionada | 12.370.010 | 311 | 81305500050 | 17.450.030 | 145 | 81307256065 | 09.051.307 | 263 | 81506106077 | 13.60965 |
| 224 | 51065009426 | | 311 | 81305500054 | 17.450.025 | 145 | 81307256065 | 09.3261.00 | 263 | 81506106077 | 13.62509 |
| | Reacondicionada | 12.370.045 | 311 | 81305500056 | 17.450.020 | 144 | 81307256065 | 09.625.436 | 263 | 81506106078 | 13.60964 |
| 225 | 51065009457 | | 309 | 81305500060 | 17.430.010 | ** | 81307256065 | VG-3261 | 263 | 81506106078 | 13.62508 |
| | Reacondicionada | 12.370.065 | 309 | 81305500063 | 17.430.035 | 144 | 81307256067 | 09.051.406 | 263 | 81506106081 | 13.62322 |
| 223 | 51065009476 | | 309 | 81305500067 | 17.430.035 | 146 | 81307256067 | 09.3262.00 | 263 | 81506106083 | 13.62320 |
| | Reacondicionada | 12.370.015 | 311 | 81305500069 | 17.450.015 | ** | 81307256067 | VG-3262 | 263 | 81506106084 | 13.62321 |
| 224 | 51065009479 | | 309 | 81305500071 | 17.430.035 | ** | 81307256068 | VG-3262 | 263 | 81506106126 | 13.62987 |
| | Reacondicionada | 12.370.040 | 309 | 81305500072 | 17.430.030 | 144 | 81307256069 | 09.051.406 | 263 | 81506106127 | 13.62988 |
| 224 | 51065009480 | | 309 | 81305500073 | 17.430.035 | ** | 81307256069 | VG-3262 | 263 | 81506106128 | 13.60964 |
| | Reacondicionada | 12.370.060 | 309 | 81305500077 | 17.430.035 | ** | 81307256074 | 09.051.157 | 263 | 81506106128 | 13.62508 |
| 224 | 51065009492 | | 311 | 81305500078 | 17.450.015 | 144 | 81307256074 | 09.625.436 | 263 | 81506106129 | 13.60965 |
| | Reacondicionada | 12.370.050 | 309 | 81305500087 | 17.430.035 | ** | 81307256084 | 970.051.412.7 | 263 | 81506106129 | 13.62509 |
| 223 | 51065009495 | | 311 | 81305500087 | 17.450.010 | 145 | 81307256086 | 09.051.307 | 277 | 81506106132 | 13.66046 |
| | Reacondicionada | 12.370.020 | 309 | 81305500088 | 17.430.035 | 144 | 81307256086 | 09.051.414 | 263 | 81506106139 | 13.62013 |
| 224 | 51065009543 | | 309 | 81305500094 | 17.430.035 | 144 | 81307256086 | 09.625.436 | 263 | 81506106140 | 13.62012 |
| | Reacondicionada | 12.370.055 | 310 | 81305500096 | 17.440.010 | ** | 81307256086 | VG-3261 | 263 | 81506106151 | 13.62322 |
| 225 | 51065009545 | | 310 | 81305500101 | 17.440.010 | ** | 81307256092 | 970.051.412.7 | 263 | 81506106153 | 13.62320 |
| | Reacondicionada | 12.370.070 | 310 | 81305500102 | 17.440.010 | 144 | 81307256093 | 09.625.436 | 263 | 81506106154 | 13.62321 |
| 225 | 51065009546 | | 310 | 81305500104 | 17.440.010 | 145 | 81307259025 | 09.3200.00 | 263 | 81506106165 | 13.62303 |
| | Reacondicionada | 12.370.075 | 310 | 81305500104 | 17.440.020 | 145 | 81307259026 | 09.051.111 | 263 | 81506106166 | 13.62304 |
| 225 | 51065009547 | | 309 | 81305500106 | 17.430.035 | 145 | 81307259031 | 09.3208.00 | 263 | 81506106169 | 13.62988 |
| | Reacondicionada | 12.370.080 | 309 | 81305500107 | 17.430.035 | 145 | 81307259064 | 09.051.307 | 263 | 81506106170 | 13.62987 |
| 226 | 51065009548 | | 309 | 81305500109 | 17.430.035 | ** | 81307259064 | VG-3261 | 263 | 81506106176 | 13.62012 |
| | Reacondicionada | 12.370.085 | 311 | 81305500109 | 17.450.040 | ** | 81307259084 | 970.051.412.7 | 263 | 81506106177 | 13.62013 |
| 232 | 51065996033 | 12.R380.065 | 309 | 81305500110 | 17.430.035 | 173 | 81327346001 | 10.0030.04 | 263 | 81506106181 | 13.62456 |
| 223 | 51065996040 | 12.R370.010 | 309 | 81305500116 | 17.430.035 | 173 | 81327346024 | 10.0030.02 | 263 | 81506106182 | 13.62455 |
| 223 | 51065996052 | 12.R370.015 | 309 | 81305500119 | 17.430.020 | 173 | 81327349001 | 10.0030.04 | 263 | 81506106187 | 13.60965 |
| 226 | 51065996081 | 12.R370.105 | 157 | 81307156065 | 09.715.607 | 129 | 81436106025 | 08.222.703 | 263 | 81506106187 | 13.62509 |
| 29 | 51540007079 | 01.1200.155 | 157 | 81307156077 | 09.715.607 | 133 | 81436106054 | 08.1294.00 | 263 | 81506106188 | 13.60964 |
| 53 | 51541056006 | 01.2300.10 | 157 | 81307156113 | 09.R715.613 | ** | 81436106054 | SV-1294 | 263 | 81506106188 | 13.62508 |
| 53 | 51541056008 | 01.2300.20 | 157 | 81307156115 | 09.715.607 | 133 | 81436106057 | 08.1294.00 | 263 | 81506106193 | 13.62208 |
| 16 | 51541146045 | 01.1300.10 | 152 | 81307156119 | 09.715.611 | ** | 81436106057 | SV-1294 | 263 | 81506106194 | 13.62578 |
| 16 | 51541146053 | 01.1300.10 | 152 | 81307156120 | 09.715.612 | 133 | 81436106058 | 08.1294.00 | 263 | 81506106203 | 13.62456 |
| 16 | 51541146054 | 01.1300.10 | 157 | 81307156135 | 09.715.613 | ** | 81436106058 | SV-1294 | 263 | 81506106204 | 13.62455 |
| ** | 51961010048 | 630.0534.1 | 152 | 81307156138 | 09.R715.611 | 133 | 81436106059 | 08.1294.00 | 263 | 81506106210 | 13.62304 |
| 53 | 5411300108 + Pistón | 01.2300.30 | 152 | 81307156139 | 09.R715.612 | ** | 81436106059 | SV-1294 | 263 | 81506106211 | 13.62303 |
| 174 | 81117016046 | 10.265653 | 145 | 81307256014 | 09.051.111 | 133 | 81436106060 | 08.1294.00 | 263 | 81506106212 | 13.62321 |
| 176 | 81157016079 | 10.1883.30 | 204 | 81307256016 | 11.R2925 | ** | 81436106060 | SV-1294 | 263 | 81506106213 | 13.62320 |
| 175 | 81157016080 | 10.1883.85 | 204 | 81307256017 | 11.R2926 | 133 | 81436106061 | 08.1295.00 | 263 | 81506106214 | 13.62012 |
| 176 | 81157016099 | 10.1883.30 | 145 | 81307256025 | 09.3200.00 | ** | 81436106061 | SV-1295 | 263 | 81506106215 | 13.62013 |
| 176 | 81157016112 | 10.1883.30 | 145 | 81307256026 | 09.051.111 | 133 | 81436106079 | 08.1294.00 | 263 | 81506106216 | 13.62578 |
| 175 | 81157016203 | 10.1883.50 | 145 | 81307256026 | 09.3200.00 | ** | 81436106079 | SV-1294 | 263 | 81506106220 | 13.60964 |
| 172 | 81259020038 | 10.4720.00 | 145 | 81307256027 | 09.051.111 | ** | 81436106081 | SV-1325 | 263 | 81506106220 | 13.62508 |
| 172 | 81259020127 | 10.4720.00 | 145 | 81307256027 | 09.3200.00 | 129 | 81436106082 | 08.R464002 | 263 | 81506106221 | 13.60965 |
| 173 | 81259026080 | 10.4750.00 | 145 | 81307256031 | 09.051.132 | 129 | 81436106095 | 08.222.703 | 263 | 81506106221 | 13.62509 |
| 209 | 81259026120 | 11.R2961 | 145 | 81307256031 | 09.3200.00 | 130 | 81436106116 | 08.8010.40 | 263 | 81506106222 | 13.62987 |
| 209 | 81259026122 | 11.R2962 | 145 | 81307256031 | 09.3208.00 | 130 | 81436106117 | 08.8010.40 | 263 | 81506106223 | 13.62988 |
| 209 | 81259026161 | 11.R2963 | 145 | 81307256032 | 09.051.132 | 132 | 81436106129 | 08.8010.80 | 265 | 81506106228 | 13.62811 |
| 209 | 81259026175 | 11.R2964 | 145 | 81307256032 | 09.3208.00 | 130 | 81436196004 | 08.3032.00 | 265 | 81506106229 | 13.62812 |
| 131 | 81259370010 | 08.4410.70 | 145 | 81307256040 | 09.R051.111 | 135 | 81436196004 | 08.3111.00 | 263 | 81506106231 | 13.62322 |
| 131 | 81259370015 | 08.4410.70 | 145 | 81307256047 | 09.R051.132 | 173 | 81436216001 | 10.9640.00 | 275 | 81506106260 | 13.90011 |
| 131 | 81259370016 | 08.4410.50 | 144 | 81307256049 | 09.051.406 | 288 | 81436400077 | 14.2545.00 | 275 | 81506106261 | 13.90010 |

CRUCE DE REFERENCIAS: REFERENCIAS ORIGINALES / AIR FREN

CROSS REFERENCE LIST: ORIGINAL REFERENCES / AIR FREN

| Pág. MAN | AIR-FREN | Pág. MAN | AIR-FREN | Pág. MAN | AIR-FREN | Pág. MERCEDES | AIR-FREN | | | | |
|----------|-------------|-------------|----------|-------------|---------------|---------------|---------------|--------------|-----|------------|---------------|
| 322 | 81508226007 | 18.R650.005 | 183 | 81521306013 | 10.3200.60 | 172 | 81749209011 | 10.4720.00 | 314 | 0002520646 | 17.460.075 |
| 323 | 81508226008 | 18.R650.070 | 82 | 81521306031 | 03.105508 | 121 | 81810117110 | 07.561008 | ** | 0002540047 | 970.051.431.0 |
| 324 | 81508226019 | 18.R750.030 | 82 | 81521306048 | 03.105508 | ** | 81962100052 | 3F0320060 | 310 | 0002543008 | 17.440.010 |
| 324 | 81508226020 | 18.R750.005 | 82 | 81521306053 | 03.105508 | ** | 81962100101 | 3F0450260 | 173 | 0002601457 | 10.0030.04 |
| 323 | 81508226023 | 18.R650.075 | 80 | 81521306104 | 03.R627001 | ** | 81962100293 | 312010360 | 174 | 0002602803 | 10.1880.20 |
| 66 | 81511016203 | 02.1612.20 | 83 | 81521306219 | 03.527013 | ** | 81962100302 | 340190030 | 174 | 0002602863 | 10.1880.20 |
| 66 | 81511016207 | 02.1612.20 | 83 | 81521306222 | 03.527013 | ** | 81962100440 | 3B1240090 | 174 | 0002603963 | 10.1880.20 |
| 66 | 81511016211 | 02.1612.20 | 115 | 81521516008 | 06.559160 | ** | 81962100441 | 3B1240080 | 174 | 0002604163 | 10.1880.20 |
| 66 | 81511016216 | 02.1612.20 | 116 | 81521516037 | 06.569110 | 191 | 81963400237 | 10.3500.22R | 174 | 0002604663 | 10.1880.20 |
| 66 | 81511019203 | 02.1612.20 | 116 | 81521516038 | 06.569110 | 191 | 81963400238 | 10.3500.22A | 169 | 0002606857 | 10.4600.40 |
| 71 | 81511130012 | 02.1616L | 116 | 81521516048 | 06.R6040 | 191 | 81963400278 | 10.3500.16R | 174 | 0002607063 | 10.1880.10 |
| 191 | 81512206037 | 10.579013 | 116 | 81521516055 | 06.R6040 | 191 | 81963400279 | 10.3500.16A | 141 | 0002900247 | 09.R051.114 |
| 191 | 81512206039 | 10.579013 | 116 | 81521516061 | 06.R6040 | 304 | 8196503039 | 16.6890.00 | 204 | 0002900347 | 11.R2922 |
| 191 | 81512206042 | 10.579013 | 116 | 81521516073 | 06.559130 | 290 | 81981256033 | 14.7031.00 | 141 | 0002900647 | 09.R051.129 |
| 191 | 81512206066 | 10.579013 | 116 | 81521516082 | 06.559130 | 193 | 81991643673 | 10.4510.00 | 154 | 0002900911 | 09.R295.040 |
| 192 | 81512206120 | 10.579014 | 116 | 81521516092 | 06.559130 | 105 | 82523016000 | 05.557004 | 145 | 0002903267 | 09.R051.131 |
| 182 | 81512306006 | 10.R3800E | 116 | 81521519092 | 06.559130 | 105 | 82523016015 | 05.009300 | 155 | 0002903412 | 09.R295.600 |
| 188 | 81512306012 | 10.3200.50 | 107 | 81521616177 | 05.R700403 | 104 | 82523106008 | 05.2458.51 | 155 | 0002904567 | 09.R295.540 |
| 183 | 81512606037 | 10.R8321 | ** | 81521616177 | 11.R2959 | 129 | 84436106006 | 08.933.492 | 153 | 0002904667 | 09.R295.530 |
| 182 | 81521006079 | 10.2950.45 | 84 | 81521616205 | 03.527018 | 173 | 84521606013 | 10.4750.00 | 155 | 0002904667 | 09.R295.600 |
| 121 | 81521016022 | 07.561007 | 181 | 81521616229 | 10.5310.80 | 80 | 85 50001 4354 | 03.527003 | 154 | 0002904667 | 09.R295.820 |
| 181 | 81521016069 | 10.R5210 | 181 | 81521616269 | 10.R5310 | 175 | 88157016202 | 10.1883.50 | 146 | 0002950018 | 09.051.137 |
| 121 | 81521016073 | 07.561007 | 181 | 81521616288 | 10.5310.80 | 175 | 88157016203 | 10.1883.50 | 145 | 0002950018 | 09.3200.00 |
| 121 | 81521016081 | 07.561007 | 107 | 81521619221 | 05.700000 | 121 | 88521016005 | 07.561009 | 147 | 0002950218 | 09.051.159 |
| 181 | 81521016150 | 10.5310.80 | 169 | 81521706064 | 10.7060.00 | 161 | 88521026007 | 10.410106 | 143 | 0002950660 | 09.R051.107 |
| 181 | 81521016161 | 10.5310.80 | 169 | 81521706128 | 10.7060.00 | 82 | 88523206230 | 03.105510 | 146 | 0002950818 | 09.051.151 |
| 122 | 81521016175 | 07.7020.70 | 94 | 81523155160 | 04.4239.00 | 290 | 88981256201 | 14.7031.00 | 147 | 0002950918 | 09.051.159 |
| 122 | 81521016185 | 07.7020.70 | 94 | 81523155160 | 04.4239.00 | 80 | 90810111219 | 03.240.654.0 | ** | 0002950918 | VG-3361 |
| 122 | 81521016186 | 07.7020.70 | 96 | 81523156068 | 04.4238.00 | 115 | 90810114463 | 06.645.526 | 146 | 0002951018 | 09.051.151 |
| 181 | 81521016189 | 10.5310.80 | 91 | 81523156078 | 04.240.726.21 | 183 | 90810115146 | 10.3200.60 | 147 | 0002951318 | 09.051.164 |
| 121 | 81521016191 | 07.561009 | 91 | 81523156078 | 04.240.726.23 | 175 | 90810127158 | 10.1883.50 | 147 | 0002951418 | 09.051.159 |
| 201 | 81521016229 | 11.R2905 | 91 | 81523156082 | 04.240.726.21 | 175 | 90810127159 | 10.1883.50 | ** | 0002952818 | 970.051.431.0 |
| 195 | 81521016241 | 10.432407 | 96 | 81523156103 | 04.R631008 | 80 | 99 10036 0073 | 03.527003 | 154 | 0002956806 | 09.295.820 |
| 195 | 81521016246 | 10.432407 | 95 | 81523156106 | 04.R631010 | 107 | 99100360321 | 05.700000 | 154 | 0002958206 | 09.295.820 |
| 195 | 81521016246 | 10.432407.1 | 91 | 81523156123 | 04.240.726.21 | 173 | 99100360458 | 10.2001.00 | 129 | 0003200167 | 08.R464002 |
| 122 | 81521016257 | 07.7020.60 | 91 | 81523156124 | 04.240.726.21 | | | | 137 | 0003200258 | 08.R8030 |
| 195 | 81521016264 | 10.432407.1 | 94 | 81523156129 | 04.R4214 | | | | 209 | 0003200858 | 11.R2961 |
| 195 | 81521016266 | 10.432407.1 | 91 | 81523156130 | 04.240.726.21 | | | | 209 | 0003201258 | 11.R2963 |
| 195 | 81521016275 | 10.432407 | 93 | 81523156136 | 04.4213.00 | | | | 209 | 0003201358 | 11.R2964 |
| 180 | 81521016279 | 10.R5410 | 93 | 81523156143 | 04.R4213 | | | | 129 | 0003275025 | 08.222.703 |
| 121 | 81521016281 | 07.561007 | 94 | 81523156147 | 04.4239.00 | | | | 130 | 0003275125 | 08.3032.00 |
| 180 | 81521016286 | 10.5010.00 | 94 | 81523156150 | 04.4239.00 | | | | 135 | 0003275125 | 08.3111.00 |
| 161 | 81521020008 | 10.1867.10 | 94 | 81523156156 | 04.4216.00 | | | | 129 | 0003276025 | 08.222.703 |
| 161 | 81521020009 | 10.1867.10 | 94 | 81523156158 | 04.4239.00 | | | | 137 | 0003281925 | 08.413042 |
| 161 | 81521020010 | 10.1867.10 | 94 | 81523156160 | 04.4216.00 | | | | 137 | 0003282025 | 08.413043 |
| 161 | 81521026036 | 10.410102 | 94 | 81523156161 | 04.4216.00 | | | | 137 | 0003282030 | 08.005001 |
| 161 | 81521026046 | 10.410104 | 91 | 81523156165 | 04.240.726.21 | | | | 137 | 0003282125 | 08.413043 |
| 161 | 81521026047 | 10.410104 | 93 | 81523156211 | 04.4211.10 | | | | 137 | 0003282130 | 08.005002 |
| 161 | 81521026055 | 10.410104 | 94 | 81523159150 | 04.4239.00 | | | | ** | 0003283230 | SV-1280 |
| 161 | 81521026058 | 10.410104 | 94 | 81523159156 | 04.4216.00 | | | | 137 | 0003283430 | 08.005101 |
| 161 | 81521026061 | 10.410104 | 83 | 81523207138 | 03.527013 | | | | 137 | 0003283730 | 08.005102 |
| 161 | 81521026101 | 10.410120 | 83 | 81523209138 | 03.527013 | | | | 132 | 0003284530 | 08.8010.90 |
| ** | 81521029104 | 206096 | ** | 81541150009 | 01.391.102.2 | | | | 130 | 0003290425 | 08.3032.00 |
| 162 | 81521086025 | 10.1867.70 | ** | 81541160002 | 01.5770 | | | | 135 | 0003290425 | 08.3111.00 |
| 102 | 81521166059 | 05.545023 | 16 | 81541180014 | 01.391.400 | | | | 130 | 0003290825 | 08.3032.00 |
| 102 | 81521166062 | 05.545023 | ** | 81541246013 | 01.391.400.1 | | | | 135 | 0003290825 | 08.3111.00 |
| 102 | 81521166067 | 05.545021 | 54 | 81541246015 | 01.391.200 | | | | 175 | 0003530255 | 10.1883.70 |
| 102 | 81521166068 | 05.545021 | ** | 81541246019 | 01.5771 | | | | 322 | 0004200682 | 18.R650.005 |
| 101 | 81521166070 | 05.545004 | 193 | 81544016001 | 10.1100.00 | | | | 65 | 0004209924 | 02.239.016.1 |
| 101 | 81521166071 | 05.545017 | 193 | 81544019001 | 10.1100.00 | | | | 71 | 0004212086 | 02.1802 |
| 102 | 81521166074 | 05.545022 | 172 | 81749206011 | 10.4720.00 | | | | 71 | 0004212986 | 02.1616 |
| 102 | 81521166075 | 05.545022 | 172 | 81749206016 | 10.R4720 | | | | 71 | 0004214286 | 02.1601L |
| 101 | 81521169071 | 05.545017 | 172 | 81749206017 | 10.4730.00 | | | | 71 | 0004216286 | 02.1651L |
| 102 | 81521169075 | 05.545022 | 172 | 81749206019 | 10.R4730 | | | | 71 | 0004231286 | 02.1651 |

MERCEDES

Pág. MERCEDES AIR-FREN

| | | |
|-----|---------------|--------------|
| 324 | 000 420 23 82 | 18.R750.005 |
| 173 | 0000702183 | 10.2001.00 |
| 174 | 0000720112 | 10.265653 |
| 174 | 0000721512 | 10.275653 |
| 174 | 0000721812 | 10.275653 |
| 173 | 0000723212 | 10.2001.00 |
| 17 | 0001301320 | 01.391.150 |
| 16 | 0001302619 | 01.1300.10 |
| 54 | 0001304420 | 01.391.200 |
| ** | 0001305120 | 01.391.400.1 |
| ** | 0001314004 | 01.391.400.1 |
| 51 | 0001315319 | 01.1300.70 |
| 174 | 0001400459 | 10.1883.90 |
| 174 | 0001400759 | 10.1883.90 |
| 71 | 0001440028 | 02.1609 |
| 312 | 0002501915 | 17.460.030 |
| 312 | 0002502515 | 17.460.030 |
| 312 | 0002506415 | 17.460.025 |
| 312 | 0002507315 | 17.460.020 |
| 312 | 0002507415 | 17.460.030 |
| 313 | 0002507515 | 17.460.040 |
| 313 | 0002507615 | 17.460.035 |
| 312 | 0002507715 | 17.460.030 |
| 314 | 0002520643 | 17.460.080 |



| Pág. | MERCEDES | AIR-FREN | Pág. | MERCEDES | AIR-FREN | Pág. | MERCEDES | AIR-FREN | Pág. | MERCEDES | AIR-FREN |
|------|------------|------------|------|------------|-------------|------|------------|-------------|------|------------|--------------|
| 183 | 0004290047 | 10.3200.30 | 195 | 0004300970 | 10.432407 | 183 | 0004321407 | 10.8321.00 | 169 | 0012600657 | 10.6300.00 |
| 183 | 0004290444 | 10.2440.15 | 123 | 0004301107 | 07.R661001 | 183 | 0004322007 | 10.4375.10 | 169 | 0012605957 | 10.6300.00 |
| 178 | 0004290644 | 10.543002 | 163 | 0004301215 | 10.410107 | 176 | 0004340501 | 10.559003 | 154 | 0012950307 | 09.295.040 |
| 183 | 0004290744 | 10.2440.15 | 163 | 0004301315 | 10.410107 | 176 | 0004340601 | 10.559002 | 152 | 0012950806 | 09.295.300 |
| 182 | 0004290831 | 10.4395.10 | 163 | 0004301415 | 10.R611010 | 176 | 0004340801 | 10.559002 | 155 | 0012952906 | 09.295.600 |
| 290 | 0004290839 | 14.7031.00 | 174 | 0004301826 | 10.1878.25 | 176 | 0004341001 | 10.559001 | 152 | 0012953006 | 09.295.300 |
| 161 | 0004291097 | 10.1867.10 | 174 | 0004301926 | 10.1878.25 | 176 | 0004341001 | 10.559003 | 146 | 0012953107 | 09.051.131 |
| 178 | 0004291795 | 10.930.930 | 195 | 0004302070 | 10.432407.1 | 176 | 0004341101 | 10.559002 | 153 | 0012955306 | 09.295.530 |
| 178 | 0004292544 | 10.543002 | 195 | 0004302170 | 10.432407 | 176 | 0004342101 | 10.559001 | 155 | 0012955407 | 09.295.540 |
| 185 | 0004292595 | 10.511000 | 178 | 0004302468 | 10.R3350 | 176 | 0004342101 | 10.559003 | 146 | 0012955607 | 09.051.128 |
| 185 | 0004292695 | 10.511000 | 195 | 0004302470 | 10.432407 | 176 | 0004342201 | 10.559002 | 155 | 0012956006 | 09.295.600 |
| 185 | 0004292795 | 10.511000 | 174 | 0004302726 | 10.1878.25 | 176 | 0004342301 | 10.559001 | 146 | 0012956707 | 09.051.131 |
| 185 | 0004292895 | 10.511000 | 202 | 0004302906 | 11.R2914 | 176 | 0004342301 | 10.559003 | 147 | 0012957006 | 09.051.159 |
| 101 | 0004293044 | 05.135517 | 163 | 0004302915 | 10.410107 | 176 | 0004342901 | 10.559001 | 157 | 0012959506 | 09.295.950 |
| 101 | 0004293044 | 05.545005 | 163 | 0004303015 | 10.410107 | 176 | 0004342901 | 10.559003 | 155 | 0012959607 | 09.295.540 |
| 183 | 0004293044 | 10.3200.30 | 174 | 0004303026 | 10.1878.25 | 176 | 0004343801 | 10.559004 | 65 | 0014200224 | 02.239.016.1 |
| 161 | 0004293395 | 10.1867.10 | 174 | 0004303426 | 10.1883.20 | 172 | 0004630952 | 10.4720.00 | 65 | 0014200324 | 02.239.020.1 |
| 161 | 0004293595 | 10.1867.10 | ** | 0004303481 | 04.4223.00 | 131 | 0005424018 | 08.4410.50 | 65 | 0014200624 | 02.239.016.1 |
| 161 | 0004293695 | 10.1867.10 | 85 | 0004303506 | 03.R527024 | 131 | 0005424080 | 08.4410.50 | 65 | 0014200724 | 02.239.020.1 |
| 191 | 0004293730 | 10.579013 | 93 | 0004303581 | 04.4212.00 | 168 | 0005480370 | 10.410200 | 65 | 0014200824 | 02.239.016.1 |
| 161 | 0004293795 | 10.1867.10 | 107 | 0004303660 | 05.R711000 | 172 | 0005860076 | 10.R4720 | 65 | 0014200924 | 02.239.016.1 |
| 191 | 0004293830 | 10.579002 | 105 | 0004303706 | 05.R009000 | 204 | 0005863029 | 11.R2925 | 323 | 0014205283 | 18.R650.070 |
| 191 | 0004293930 | 10.579005 | 203 | 0004304706 | 11.R2915 | 208 | 0005864729 | 11.R2960 | 192 | 0014290430 | 10.579015 |
| 191 | 0004294030 | 10.579006 | 174 | 0004304926 | 10.285654 | 101 | 0005865742 | 05.R645002 | 101 | 0014292044 | 05.545005 |
| 183 | 0004294044 | 10.3200.60 | 181 | 0004304960 | 10.R5310 | 182 | 0005865842 | 10.R1965 | 101 | 0014292144 | 05.575537 |
| 178 | 0004294144 | 10.543002 | 179 | 0004304981 | 10.543012 | 182 | 0005866242 | 10.R3800E | 183 | 0014292444 | 10.3200.30 |
| 192 | 0004294530 | 10.579014 | 175 | 0004305026 | 10.1883.75 | 181 | 0005866842 | 10.R5210 | 101 | 0014293044 | 05.545003 |
| 191 | 0004294930 | 10.579013 | 93 | 0004305481 | 04.4211.00 | 123 | 0005867643 | 07.R661005 | 182 | 0014293844 | 10.2950.50 |
| 191 | 0004295430 | 10.579002 | 93 | 0004305581 | 04.4212.00 | 174 | 0005867726 | 10.R1880 | 182 | 0014294744 | 10.2950.50 |
| 178 | 0004295444 | 10.055527 | ** | 0004305681 | 04.4223.00 | 93 | 0005868043 | 04.R4212 | 182 | 0014294844 | 10.2950.50 |
| 191 | 0004295530 | 10.579005 | 93 | 0004305781 | 04.4211.10 | 178 | 0005868342 | 10.R430527 | 182 | 0014295144 | 10.2950.80 |
| 191 | 0004295630 | 10.579006 | 93 | 0004306481 | 04.4212.00 | 82 | 0005868643 | 03.105508 | 182 | 0014295344 | 10.2950.35 |
| 162 | 0004295695 | 10.1867.70 | ** | 0004306681 | 04.4223.00 | 207 | 0005869943 | 11.R2951 | 101 | 0014295444 | 05.545005 |
| 191 | 0004295830 | 10.579005 | 106 | 0004307560 | 05.R633001 | 172 | 0007600378 | 10.4730.00 | 101 | 0014296044 | 05.545005 |
| 182 | 0004295844 | 10.2950.60 | 81 | 0004308506 | 03.R527006 | 172 | 0007600478 | 10.R4730 | 182 | 0014296044 | 10.2950.60 |
| 191 | 0004295930 | 10.579002 | ** | 0004309181 | 04.4223.00 | 172 | 0007632552 | 10.4720.00 | 182 | 0014296144 | 10.2950.10 |
| 191 | 0004295930 | 10.579006 | 95 | 0004309581 | 04.4220.00 | 32 | 0011302615 | 01.R391.143 | 182 | 0014296344 | 10.2950.60 |
| 182 | 0004295944 | 10.2950.20 | 95 | 0004309681 | 04.4228.00 | 17 | 0011313601 | 01.1200.15 | 182 | 0014296444 | 10.2950.90 |
| 191 | 0004296130 | 10.579005 | ** | 0004309881 | 04.4223.00 | 17 | 0011315201 | 01.1200.15 | 101 | 0014296844 | 05.135517 |
| 182 | 0004296230 | 10.2950.60 | 71 | 0004310728 | 02.1601 | 17 | 0011315201 | 01.R391.101 | 182 | 0014297644 | 10.2950.50 |
| 191 | 0004296230 | 10.579006 | 288 | 0004310735 | 14.2545.00 | 17 | 0011315401 | 01.1200.15 | 182 | 0014297744 | 10.2950.35 |
| 182 | 0004296330 | 10.2950.50 | 193 | 0004310815 | 10.1100.00 | 17 | 0011315501 | 01.1200.15 | 182 | 0014298044 | 10.2950.90 |
| 191 | 0004296330 | 10.579013 | 183 | 0004311207 | 10.2440.15 | 16 | 0011319401 | 01.1200.10 | 101 | 0014299144 | 05.135517 |
| 182 | 0004296444 | 10.2950.35 | 290 | 0004311431 | 14.7031.00 | 312 | 0012500515 | 17.460.010 | 182 | 0014299444 | 10.2950.55 |
| 101 | 0004296544 | 05.545003 | 71 | 0004311728 | 02.1612 | 312 | 0012500615 | 17.460.015 | 182 | 0014299844 | 10.2950.90 |
| 101 | 0004296544 | 05.545005 | 121 | 0004311806 | 07.561008 | 313 | 0012500915 | 17.460.055 | 96 | 0014300081 | 04.4224.00 |
| 182 | 0004297544 | 10.2950.90 | 96 | 0004311916 | 04.4234.00 | 313 | 0012504715 | 17.460.055 | 95 | 0014300281 | 04.4220.00 |
| 191 | 0004297630 | 10.579001 | 71 | 0004311928 | 02.1802L | 312 | 0012504815 | 17.460.010 | 97 | 0014300281 | 04.4225.00 |
| 182 | 0004297644 | 10.2950.60 | 184 | 0004312115 | 10.8210.00 | 312 | 0012504915 | 17.460.015 | 80 | 0014300460 | 03.R627001 |
| 191 | 0004297730 | 10.579001 | 71 | 0004312128 | 02.1616L | 313 | 0012506215 | 17.460.055 | 80 | 0014300660 | 03.R627002 |
| 191 | 0004297830 | 10.579013 | 107 | 0004313112 | 05.6120.40 | 313 | 0012506315 | 17.460.055 | 96 | 0014300781 | 04.4224.00 |
| 191 | 0004297930 | 10.579002 | 161 | 0004313615 | 10.410106 | 312 | 0012506415 | 17.460.010 | 97 | 0014300981 | 04.4225.00 |
| 191 | 0004298030 | 10.579005 | 161 | 0004313635 | 10.410106 | 312 | 0012506515 | 17.460.010 | 95 | 0014301681 | 04.4220.00 |
| 191 | 0004298130 | 10.579006 | 161 | 0004313715 | 10.410106 | 312 | 0012506615 | 17.460.015 | 97 | 0014301681 | 04.4225.00 |
| 183 | 0004299244 | 10.3200.60 | 161 | 0004313815 | 10.410106 | 312 | 0012506715 | 17.460.015 | 96 | 0014301881 | 04.4224.00 |
| 182 | 0004299444 | 10.2950.10 | 161 | 0004316515 | 10.410106 | 312 | 0012507915 | 17.460.010 | 203 | 0014303060 | 11.R2919 |
| 191 | 0004299530 | 10.579002 | 161 | 0004316715 | 10.410106 | 312 | 0012508015 | 17.460.015 | 95 | 0014303281 | 04.4221.00 |
| 174 | 0004300126 | 10.1883.20 | 161 | 0004316815 | 10.410106 | 313 | 0012508115 | 17.460.055 | 95 | 0014303681 | 04.4220.00 |
| 174 | 0004300226 | 10.1883.20 | 123 | 0004317906 | 07.561003 | 313 | 0012508415 | 17.460.055 | 95 | 0014304581 | 04.4228.00 |
| 176 | 0004300509 | 10.559002 | 81 | 0004319405 | 03.491102 | 312 | 0012508615 | 17.460.010 | 121 | 0014304960 | 07.R661004 |
| 185 | 0004300569 | 10.511000 | 183 | 0004320607 | 10.4375.10 | 312 | 0012508815 | 17.460.015 | 95 | 0014306081 | 04.4220.00 |
| 107 | 0004300860 | 05.R700403 | 183 | 0004320807 | 10.4375.10 | 313 | 0012509715 | 17.460.055 | 95 | 0014306181 | 04.4228.00 |
| ** | 0004300860 | 11.R2959 | 183 | 0004321007 | 10.8321.00 | 312 | 0012509815 | 17.460.010 | 96 | 0014306581 | 04.4224.00 |
| 201 | 0004300907 | 11.R2905 | 183 | 0004321107 | 10.4375.10 | 169 | 0012600057 | 10.4600.40 | 95 | 0014307181 | 04.4228.00 |

CRUCE DE REFERENCIAS: REFERENCIAS ORIGINALES / AIR FREN

CROSS REFERENCE LIST: ORIGINAL REFERENCES / AIR FREN

| Pág. | MERCEDES | AIR-FREN | Pág. | MERCEDES | AIR-FREN | Pág. | MERCEDES | AIR-FREN | Pág. | MERCEDES | AIR-FREN |
|------|------------|------------|------|------------|-------------|------|------------|-------------------------|------|-------------|--------------|
| 122 | 0014307760 | 07.R661003 | 173 | 0019978536 | 10.4750.00 | 121 | 0024318706 | 07.561002 | 177 | 0039977536 | 10.559005 |
| ** | 0014308760 | 11.R2928 | 177 | 0019979136 | 10.559007 | 84 | 0024318805 | 03.527023 | 31 | 0041310501 | 01.1200.175 |
| 146 | 0014309781 | 09.051.131 | 312 | 0022500815 | 17.460.015 | 121 | 0024318806 | 07.561009 | 67 | 0044203618 | 02.2030.00 |
| 121 | 0014310006 | 07.561001 | 313 | 0022503715 | 17.460.050 | 115 | 0024319106 | 06.559120 | 102 | 0044290644 | 05.545021 |
| 115 | 0014310106 | 06.559120 | 313 | 0022504115 | 17.460.045 | 116 | 0024319106 | 06.6050.60 | 102 | 0044291144 | 05.545021 |
| 105 | 0014310405 | 05.557004 | 314 | 0022504415 | 17.460.060 | 115 | 0024319406 | 06.539110 | 185 | 0044293444 | 10.5018.10 |
| ** | 0014310516 | 206092 | 313 | 0022504715 | 17.460.045 | 204 | 0025862842 | 11.R2921 | 185 | 0044293544 | 10.5018.10 |
| 121 | 0014310606 | 07.561001 | 314 | 0022504915 | 17.460.060 | 115 | 0025862843 | 06.R659008 | 185 | 0044293644 | 10.5018.10 |
| 121 | 0014311206 | 07.561001 | 314 | 0022506315 | 17.460.060 | 203 | 0025865242 | 11.R2920 | 101 | 0044293844 | 05.545004 |
| 121 | 0014312206 | 07.561006 | 313 | 0022506715 | 17.460.045 | 95 | 0025867243 | 04.R631010 | 188 | 0044294944 | 10.3200.50 |
| 121 | 0014312206 | 07.561007 | 313 | 0022506815 | 17.460.050 | 96 | 0025867443 | 04.R631008 | 102 | 0044296344 | 05.545022 |
| 121 | 0014312226 | 07.561007 | 314 | 0022508315 | 17.460.060 | 85 | 0025868743 | 03.R527024 | 101 | 0044297644 | 05.545017 |
| 106 | 0014313312 | 05.533001 | 154 | 0022950407 | 09.295.040 | 105 | 0025869343 | 05.R657001 | 84 | 0044312505 | 03.527023 |
| 121 | 0014313406 | 07.561001 | 323 | 0024200383 | 18.R650.080 | 105 | 0025869543 | 05.R657002 | 85 | 0044314605 | 03.527025 |
| 82 | 0014313505 | 03.3070.10 | 182 | 0024290044 | 10.2950.20 | 184 | 0029975236 | 10.1881.10 | 85 | 0044315905 | 03.527025 |
| 115 | 0014313505 | 06.559110 | 182 | 0024290044 | 10.2950.90 | 183 | 0034290744 | 10.2440.15 | 204 | 0054205424 | 11.R2921 |
| 106 | 0014313512 | 05.533001 | 181 | 0024291744 | 10.5210.60 | 101 | 0034291644 | 05.135517 | 67 | 0054209918 | 02.2030.00 |
| 82 | 0014313805 | 03.105510 | 182 | 0024294244 | 10.2950.00 | 185 | 0034291844 | 10.5018.10 | 67 | 0064201117 | 02.1624.00 |
| 115 | 0014313806 | 06.559110 | 182 | 0024295444 | 10.2950.10 | 183 | 0034292844 | 10.2440.15 | 67 | 0064203318 | 02.2030.00 |
| 105 | 0014314005 | 05.557002 | 182 | 0024296049 | 10.2950.00 | 182 | 0034294244 | Tara 1,1 BAR 10.2950.15 | 67 | 0064203918 | 02.1624.00 |
| 121 | 0014314106 | 07.561006 | 182 | 0024297044 | 10.2950.20 | 101 | 0034295244 | 05.545003 | 66 | 0064205224 | 02.239.016.6 |
| 121 | 0014314106 | 07.561007 | 182 | 0024297144 | 10.2950.20 | 101 | 0034297844 | 05.575537 | 65 | 0064205417 | 02.239.020.1 |
| 121 | 0014314206 | 07.561006 | 182 | 0024298344 | 10.2950.55 | 95 | 0034300381 | 04.4228.00 | 67 | 0064205618 | 02.1624.00 |
| 121 | 0014314206 | 07.561007 | 101 | 0024298444 | 05.135517 | 115 | 0034300781 | 06.R639008 | 67 | 0064206818 | 02.2424.00 |
| ** | 0014314212 | 05.711.000 | 181 | 0024298744 | 10.5210.10 | 183 | 0034303081 | 10.R8321 | 67 | 0074201218 | 02.2424.00 |
| 121 | 0014314306 | 07.561006 | 96 | 0024300381 | 04.4224.00 | 96 | 0034303181 | 04.R631008 | 67 | 0074202618 | 02.2030.00 |
| 121 | 0014314306 | 07.561007 | 203 | 0024301560 | 11.R2920 | 90 | 0034303281 | 04.R631009 | 67 | 0074207018 | 02.2030.00 |
| 115 | 0014314606 | 06.559160 | 105 | 0024301660 | 05.R657000 | 95 | 0034303381 | 04.R631010 | 67 | 0084202018 | 02.2030.00 |
| 105 | 0014314705 | 05.557002 | 105 | 0024301760 | 05.R657002 | 94 | 0034305281 | 04.R4214 | 65 | 0084202524 | 02.239.020.1 |
| 115 | 0014314706 | 06.559110 | 105 | 0024301860 | 05.R657001 | 96 | 0034305381 | 04.R4238 | 67 | 0084209518 | 02.2030.00 |
| 105 | 0014314805 | 05.557002 | 95 | 0024302481 | 04.4218.00 | 180 | 0034309181 | 10.R5410 | 67 | 0084209718 | 02.2030.00 |
| 181 | 0014315706 | 10.5310.80 | 94 | 0024307581 | 04.4215.00 | 181 | 0034310106 | 10.5310.80 | 67 | 0094202218 | 02.2030.00 |
| 115 | 0014315806 | 06.539110 | 94 | 0024307781 | 04.4215.00 | 105 | 0034310205 | 05.557001 | 67 | 0094205018 | 02.1616.00 |
| 105 | 0014316705 | 05.557002 | 94 | 0024307981 | 04.4215.00 | 122 | 0034310406 | 07.561010 | 67 | 0104208418 | 02.2020.00 |
| 115 | 0014316806 | 06.559110 | 97 | 0024309081 | 04.4229.00 | 105 | 0034311305 | 05.009000 | 131 | 0105427817 | 08.4410.70 |
| 105 | 0014316905 | 05.557002 | 105 | 0024310105 | 05.557001 | 84 | 0034311505 | 03.527016 | 67 | 0114209118 | 02.3024.00 |
| 121 | 0014318206 | 07.561006 | 115 | 0024310106 | 06.559120 | 84 | 0034311705 | 03.527021 | 67 | 0124200718 | 02.3030.00 |
| 121 | 0014318206 | 07.561007 | 116 | 0024310106 | 06.6050.60 | 84 | 0034311905 | 03.527016 | 67 | 0124207118 | 02.2024.00 |
| 80 | 0014318305 | 03.527003 | 115 | 0024310206 | 06.559120 | 84 | 0034312205 | 03.527021 | 67 | 0124207318 | 02.2424.00 |
| 115 | 0014318406 | 06.559110 | 82 | 0024310505 | 03.3070.10 | 84 | 0034312605 | 03.527016 | 67 | 0134209018 | 02.2030.00 |
| 105 | 0014318705 | 05.557001 | 80 | 0024310505 | 03.527004 | 106 | 0034312712 | 05.533010 | 69 | 0154209318 | 02.2424.60 |
| 115 | 0014318706 | 06.559120 | 106 | 0024310512 | 05.533001 | 106 | 0034312712 | 05.R633001 | 69 | 0154209718 | 02.2424.60 |
| 116 | 0014318706 | 06.6050.60 | 80 | 0024310605 | 03.527004 | 84 | 0034312805 | 03.527021 | 69 | 0184205218 | 02.1624.60 |
| 80 | 0014318905 | 03.527003 | ** | 0024310615 | ZB-4534 | 84 | 0034312905 | 03.527016 | 69 | 0184205318 | 02.1624.60 |
| 115 | 0014318906 | 06.559120 | ** | 0024310715 | ZB-4534 | 84 | 0034313205 | 03.527021 | 69 | 0194205718 | 02.2424.60 |
| 116 | 0014318906 | 06.6050.60 | 80 | 0024311005 | 03.527004 | 84 | 0034313205 | 03.527021 | 305 | 0209970547 | 16.6990.10 |
| 80 | 0014319105 | 03.527003 | 163 | 0024311215 | 10.410107 | ** | 0034315406 | AE-4510 | 305 | 0209973947 | 16.6990.00 |
| 163 | 0014319215 | 10.410107 | ** | 0024311215 | LA-9010 | 116 | 0034315506 | 06.559150 | ** | 2553304 | 01.5771 |
| 115 | 0014319306 | 06.559120 | 121 | 0024311506 | 07.561002 | ** | 0034315606 | AE-4510 | 265 | 3014201138 | 13.62213 |
| 116 | 0014319306 | 06.6050.60 | 121 | 0024311606 | 07.561009 | ** | 0034315706 | AE-4510 | 265 | 3054202638 | 13.60706 |
| 121 | 0014319806 | 07.561001 | 80 | 0024312005 | 03.527004 | ** | 0034316106 | AE-4510 | 265 | 3074200138 | 13.60772 |
| 80 | 0014319905 | 03.527003 | 180 | 0024312406 | 10.5310.100 | 84 | 0034316305 | 03.527022 | 265 | 3074200238 | 13.60771 |
| 115 | 0015860643 | 06.R639007 | 80 | 0024312705 | 03.527003 | 84 | 0034316405 | 03.527022 | 265 | 3074200338 | 13.60775 |
| 93 | 0015861343 | 04.R631003 | 121 | 0024313506 | 07.561007 | 84 | 0034316505 | 03.527022 | 265 | 3074201438 | 13.60775 |
| 101 | 0015862142 | 05.R645013 | 115 | 0024314006 | 06.559120 | 84 | 0034316805 | 03.527022 | 230 | 3142002401 | 12.380.010 |
| 123 | 0015864343 | 07.R661001 | 116 | 0024314006 | 06.6050.60 | 106 | 0035860243 | 05.R633001 | 230 | 3142003701 | 12.380.010 |
| 115 | 0015865343 | 06.R639008 | 121 | 0024314606 | 07.561002 | 90 | 0035860843 | 04.R631009 | 230 | 3142003901 | 12.380.010 |
| ** | 0015865943 | 10.R3200E | 121 | 0024314706 | 07.561009 | 115 | 0035860943 | 06.R559120 | 230 | 3142004201 | 12.380.010 |
| ** | 0015868343 | 10.R3200E | 121 | 0024315206 | 07.561002 | 173 | 0039971136 | 10.4750.00 | 175 | 3273580355 | 10.1883.70 |
| 183 | 0015869543 | 10.R8321 | 121 | 0024315306 | 07.561009 | 184 | 0039972226 | 10.1881.20 | 135 | 3290425 | 08.3111.00 |
| 182 | 0017296544 | 10.2950.20 | 121 | 0024316006 | 07.561007 | 184 | 0039972626 | 10.1881.20 | 135 | 32908250080 | 08.3111.00 |
| 121 | 0017319906 | 07.561007 | 84 | 0024317005 | 03.527023 | 184 | 0039972636 | 10.1881.20 | 180 | 34309181 | 10.R5410 |
| 184 | 0019975036 | 10.1881.10 | 80 | 0024318105 | 03.527003 | 184 | 0039975936 | 10.1881.10 | 265 | 3464201538 | 13.60753 |
| 184 | 0019976136 | 10.1881.10 | 84 | 0024318105 | 03.527023 | 177 | 0039977036 | 10.559005 | 265 | 3464201638 | 13.60754 |

| Pág. | MERCEDES | AIR-FREN |
|------|------------|-------------|
| 230 | 3522004504 | 12.R380.020 |
| 230 | 3522004901 | 12.380.015 |
| 230 | 3522007401 | 12.380.015 |
| 230 | 3522008401 | 12.380.015 |
| 230 | 3522008901 | 12.380.020 |
| 230 | 3522009201 | 12.380.020 |
| 230 | 3522009401 | 12.380.015 |
| 230 | 3522009501 | 12.380.020 |
| 230 | 3522009601 | 12.380.020 |
| 230 | 3522009701 | 12.380.020 |
| 230 | 3532000301 | 12.380.015 |
| 230 | 3532000401 | 12.380.015 |
| 230 | 3532001601 | 12.380.020 |
| 230 | 3532001701 | 12.380.020 |
| 230 | 3532002101 | 12.380.015 |
| 230 | 3532003601 | 12.380.015 |
| 230 | 3532003701 | 12.380.015 |
| 230 | 3532003801 | 12.380.020 |
| 230 | 3532005601 | 12.380.020 |
| 230 | 3552000101 | 12.380.025 |
| 230 | 3552000601 | 12.380.025 |
| 230 | 3552000801 | 12.380.025 |
| 230 | 3552000901 | 12.380.025 |
| 230 | 3552001101 | 12.380.025 |
| 230 | 3552001501 | 12.380.025 |
| ** | 3572400118 | 3M9000310 |
| 265 | 3574200538 | 13.62059 |
| 265 | 3574201138 | 13.62211 |
| 265 | 3574201238 | 13.62212 |
| 263 | 3574201338 | 13.62455 |
| 265 | 3574201338 | 13.62809 |
| 263 | 3574201438 | 13.62456 |
| 265 | 3574201438 | 13.62810 |
| 265 | 3574201538 | 13.62811 |
| 265 | 3574201638 | 13.62812 |
| 231 | 3642000101 | 12.380.030 |
| 231 | 3642000804 | 12.R380.030 |
| 231 | 3642000901 | 12.380.030 |
| 231 | 3642002001 | 12.380.030 |
| 95 | 3644307181 | 04.4218.00 |
| 231 | 3662000004 | 12.R380.035 |
| 231 | 3662000304 | 12.R380.035 |
| 231 | 3662000604 | 12.R380.035 |
| 231 | 3662000804 | 12.R380.035 |
| 231 | 3662000901 | 12.380.035 |
| 231 | 3662005901 | 12.380.035 |
| 233 | 3662006801 | 12.380.075 |
| 153 | 3842957006 | 09.295.530 |
| 265 | 3854201738 | 13.62040 |
| 265 | 3854201838 | 13.62041 |
| 265 | 3874200038 | 13.62173 |
| 265 | 3874200138 | 13.62174 |
| 265 | 3874200238 | 13.60953 |
| 265 | 3874200338 | 13.60952 |
| 265 | 3894200338 | 13.60753 |
| 265 | 3894200438 | 13.60754 |
| 265 | 3894200738 | 13.62308 |
| 265 | 3964200038 | 13.62308 |
| 16 | 4021300220 | 01.R391.100 |
| 53 | 4021300608 | 01.2300.20 |
| 53 | 4021310502 | 01.2300.20 |
| 53 | 4031312002 | 01.2300.10 |
| 231 | 4032004401 | 12.380.045 |
| 231 | 4032005101 | 12.380.045 |

| Pág. | MERCEDES | AIR-FREN |
|------|--|--------------|
| 233 | 4032005301 | 12.380.080 |
| 231 | 4032007001 | 12.380.040 |
| 231 | 4032007101 | 12.380.045 |
| 233 | 4032007301 | 12.380.080 |
| 232 | 4032007401 | 12.380.055 |
| 233 | 4032007601 Antigua - turbina 122 mm | 12.380.070 |
| 233 | 4032007701 Nueva - turbina 125 mm | 12.380.070 |
| ** | 4071310519 | 01.391.108.1 |
| 51 | 4111519222 | 01.1300.70 |
| 231 | 4222000104 | 12.R380.040 |
| 232 | 4222000204 | 12.R380.065 |
| 231 | 4222000304 | 12.R380.040 |
| 232 | 4222000404 | 12.R380.065 |
| 232 | 4222000501 | 12.380.060 |
| 231 | 4222000604 | 12.R380.040 |
| 232 | 4222001001 | 12.380.060 |
| 233 | 4222001101 | 12.380.085 |
| 232 | 4222001201 | 12.380.065 |
| 51 | 4411300120 | 01.391.750 |
| 51 | 4411300220 | 01.R391.124 |
| 232 | 4412000101 | 12.380.050 |
| 232 | 4412000201 | 12.380.050 |
| 232 | 4412000204 | 12.R380.050 |
| 53 | 4421300008 | 01.2300.10 |
| 51 | 4421300020 | 01.R391.124 |
| 51 | 4421300720 | 01.1300.65 |
| 51 | 4421303219 | 01.1300.70 |
| 29 | 4471300515 | 01.1200.190 |
| 51 | 4471300720 | 01.391.700 |
| 32 | 4571301615 | 01.1200.185 |
| 32 | 4571301715 | 01.1200.185 |
| 32 | 4571302315 | 01.1200.185 |
| 32 | 4571302414 | 01.1200.185 |
| 234 | 4572000501 | 12.380.110 |
| 52 | 5411300620 | 01.391.1250 |
| 52 | 5411300820 | 01.391.1300 |
| 52 | 5411302219 | 01.1300.150 |
| 52 | 5411302719 | 01.1300.150 |
| 52 | 5411311019 | 01.1300.145 |
| 52 | 5411311119 | 01.1300.140 |
| 234 | 5412001201 | 12.380.095 |
| 235 | 5422001701 | 12.380.120 |
| 235 | 5422001801 | 12.380.115 |
| 234 | 5422001901 | 12.380.100 |
| 234 | 5422002001 | 12.380.090 |
| 235 | 5422002101 | 12.380.120 |
| 235 | 5422002201 | 12.380.115 |
| 174 | 5867726 | 10.R1880 |
| 265 | 6174200238 | 13.60954 |
| 265 | 6174200338 | 13.60952 |
| 265 | 6174200438 | 13.60953 |
| 265 | 6194200238 | 13.62234 |
| 265 | 6194200338 | 13.62235 |
| 265 | 6194200638 | 13.62616 |
| 265 | 6194200738 | 13.62617 |
| 265 | 6204200038 | 13.60753 |
| 265 | 6204200138 | 13.60754 |
| 265 | 6204200238 | 13.62308 |
| 265 | 6204200338 | 13.62308 |
| 265 | 6214200038 | 13.62174 |
| 265 | 6214200138 | 13.62173 |
| 265 | 6234200438 | 13.62039 |

| Pág. | MERCEDES | AIR-FREN |
|------|------------|-------------|
| 265 | 6234200538 | 13.62038 |
| 265 | 6234200638 | 13.62039 |
| 265 | 6234200738 | 13.62038 |
| 265 | 6234201238 | 13.62234 |
| 265 | 6234201338 | 13.62235 |
| 265 | 6234201438 | 13.62234 |
| 265 | 6234201538 | 13.62235 |
| 305 | 6243560080 | 16.6990.40 |
| 265 | 6524200038 | 13.62593 |
| 265 | 6524200138 | 13.62594 |
| 265 | 6524200238 | 13.62596 |
| 265 | 6584200238 | 13.62593 |
| 265 | 6584200338 | 13.62594 |
| 84 | 6954317405 | 03.527015 |
| 107 | 6984313712 | 05.714000 |
| 149 | 6992950018 | 09.051.102 |
| 129 | 6993280030 | 08.933.492 |
| 234 | 9042000401 | 12.380.105 |
| 234 | 9042000801 | 12.380.105 |
| 234 | 9042002001 | 12.380.105 |
| 234 | 9042002601 | 12.380.105 |
| 235 | 9042006101 | 12.380.125 |
| 30 | 9061301215 | 01.1200.110 |
| 265 | 9424200038 | 13.62234 |
| 265 | 9424200138 | 13.62235 |
| 265 | 9424200238 | 13.60952 |
| 265 | 9424200338 | 13.60953 |
| 265 | 9424200638 | 13.60753 |
| 265 | 9424200738 | 13.60754 |
| 265 | 9424200838 | 13.62594 |
| 265 | 9424200938 | 13.62593 |
| 265 | 9424201038 | 13.62174 |
| 265 | 9424201138 | 13.62173 |
| 265 | 9424201238 | 13.62234 |
| 265 | 9424201338 | 13.62235 |
| 265 | 9454200038 | 13.62234 |
| 265 | 9454200038 | 13.62593 |
| 275 | 9454200038 | 13.90008 |
| 265 | 9454200138 | 13.62235 |
| 265 | 9454200138 | 13.62594 |
| 275 | 9454200138 | 13.90009 |
| 265 | 9454200238 | 13.62616 |
| 275 | 9454200238 | 13.90000 |
| 275 | 9454200338 | 13.90001 |
| 275 | 9454200438 | 13.90014 |
| 275 | 9454200538 | 13.90012 |
| 275 | 9454200638 | 13.90013 |
| 275 | 9454200738 | 13.90011 |
| 275 | 9454200838 | 13.90010 |
| 275 | 9454200938 | 13.90030 |
| 84 | 9924318105 | 03.527023 |

MIDLAND

| Pág. | MIDLAND | AIR-FREN |
|------|---------|------------|
| 71 | 18090 | 02.1609 |
| 71 | 18160 | 02.1616 |
| 71 | 18200 | 02.1601 |
| 71 | 18240 | 02.1802 |
| 71 | 18300 | 02.1651 |
| 194 | KN20021 | 10.2751.75 |
| 194 | KN20030 | 10.2000.31 |
| 194 | KN20031 | 10.2000.31 |

| Pág. | MIDLAND | AIR-FREN |
|------|---------|-------------|
| 83 | KN22100 | 03.527012 |
| 83 | KN22140 | 03.527009 |
| 83 | KN22150 | 03.527009 |
| 83 | KN22511 | 03.527010 |
| 194 | KN23000 | 10.2450.15 |
| 194 | KN25060 | 10.3200.35 |
| 189 | KN26000 | 10.2600.00 |
| 132 | KN27000 | 08.8010.100 |
| 109 | KN28060 | 05.545016 |
| 108 | KN28500 | 05.545013 |
| 108 | KN28520 | 05.545012 |
| 108 | KN28550 | 05.545020 |
| 109 | KN28600 | 05.2860.00 |
| 109 | KN28601 | 05.2860.10 |
| 179 | KN32041 | 10.543052 |
| 98 | KN3546 | 04.3546.00 |

MONTENEGRO

| Pág. | MONTENEGRO | AIR-FREN |
|------|------------|------------|
| 305 | 061001009 | 16.7090.00 |

NATO

| Pág. | NATO | AIR-FREN |
|------|------------------|---------------|
| 146 | 2520123115608 | 09.051.131 |
| 146 | 2520233115608 | 09.051.131 |
| 80 | 2530 12 301 9108 | 03.527003 |
| 80 | 2530 23 301 9108 | 03.527003 |
| 91 | 2530033145332 | 04.240.726.21 |
| 121 | 2530121219362 | 07.561008 |
| 121 | 2530121251261 | 07.561008 |
| 80 | 2530121251263 | 03.240.654.0 |
| 193 | 2530121271216 | 10.1100.00 |
| 108 | 2530121438544 | 05.557005 |
| 108 | 2530121451709 | 05.R557005 |
| 172 | 2530121457111 | 10.R4720 |
| 183 | 2530121457750 | 10.3200.60 |
| 108 | 2530121544535 | 05.557005 |
| 175 | 2530121550651 | 10.1883.50 |
| 82 | 2530121629184 | 03.105510 |
| 288 | 2530121648531 | 14.2545.00 |
| 93 | 2530121741148 | 04.4211.10 |
| 177 | 2530121789422 | 10.559007 |
| 82 | 2530121795030 | 03.105508 |
| 183 | 2530121805494 | 10.R8321 |
| 82 | 2530121806567 | 03.105510 |
| 95 | 2530121925704 | 04.4219.00 |
| 115 | 2530121947247 | 06.559160 |
| 173 | 2530121969612 | 10.4750.00 |
| 175 | 2530123002225 | 10.1883.40 |
| 91 | 2530123015678 | 04.240.726.23 |
| ** | 2530123017729 | 10.R3200E |
| 115 | 2530123019106 | 06.R559120 |
| 95 | 2530123020377 | 04.R631010 |
| 107 | 2530123030184 | 05.700000 |
| 90 | 2530123037766 | 04.R631009 |
| 96 | 2530123037826 | 04.4234.00 |
| 185 | 2530123081623 | 10.511000 |
| 181 | 2530123084591 | 10.R5210 |
| 91 | 2530123102024 | 04.240.726.21 |
| 19 | 2530123131245 | 01.1200.35 |

CRUCE DE REFERENCIAS: REFERENCIAS ORIGINALES / AIR-FREN

CROSS REFERENCE LIST: ORIGINAL REFERENCES / AIR-FREN

| Pág. | NATO | AIR-FREN |
|------|---------------|---------------|
| 115 | 2530123144046 | 06.559120 |
| 91 | 2530123145332 | 04.240.726.21 |
| 121 | 2530123145605 | 07.7020.90 |
| 97 | 2530123160083 | 04.4225.00 |
| 67 | 2530123184531 | 02.2424.00 |
| 90 | 2530123184535 | 04.565590 |
| 107 | 2530123225314 | 05.714000 |
| 96 | 2530123226904 | 04.4224.00 |
| 185 | 2530123230306 | 10.5018.10 |
| 107 | 2530123252321 | 05.R700403 |
| ** | 2530123252321 | 11.R2959 |
| 161 | 2530123253715 | 10.410106 |
| 94 | 2530123254182 | 04.4215.00 |
| 102 | 2530123255096 | 05.545021 |
| 96 | 2530123255355 | 04.R631008 |
| 177 | 2530123262790 | 10.559005 |
| 208 | 2530123269792 | 11.R2957 |
| 173 | 2530123271617 | 10.9640.00 |
| 96 | 2530123281713 | 04.4224.50 |
| 195 | 2530123295327 | 10.432407 |
| 94 | 2530123300343 | 04.R4214 |
| 94 | 2530123309119 | 04.4217.00 |
| 84 | 2530123334304 | 03.527018 |
| 186 | 2530123334882 | 10.5031.10 |
| 67 | 2530123335475 | 02.2424.00 |
| 121 | 2530123358314 | 07.561008 |
| 81 | 2530123419259 | 03.491102 |
| 81 | 2530123419259 | 03.491102 |
| ** | 2530123427335 | 10.410112 |
| 105 | 2530123429769 | 05.R009000 |
| 106 | 2530123469216 | 05.533005 |
| 84 | 2530123469974 | 03.527016 |
| 122 | 2530123480710 | 07.R661003 |
| 80 | 2530123485597 | 03.527004 |
| 105 | 2530123485615 | 05.009010 |
| 80 | 2530211251263 | 03.240.654.0 |
| 193 | 2530211271216 | 10.1100.00 |
| 108 | 2530211438544 | 05.557005 |
| 108 | 2530211451709 | 05.R557005 |
| 172 | 2530211451711 | 10.R4720 |
| 183 | 2530211457750 | 10.3200.60 |
| 108 | 2530211544535 | 05.557005 |
| 175 | 2530211550651 | 10.1883.50 |
| 121 | 2530211621931 | 07.561007 |
| 288 | 2530211648531 | 14.2545.00 |
| 93 | 2530211741148 | 04.4211.10 |
| 177 | 2530211789422 | 10.559007 |
| 82 | 2530211795030 | 03.105508 |
| 183 | 2530211805494 | 10.R8321 |
| 95 | 2530211925704 | 04.4219.00 |
| 115 | 2530211947247 | 06.559160 |
| 173 | 2530211969612 | 10.4750.00 |
| 175 | 2530233002225 | 10.1883.40 |
| 91 | 2530233015678 | 04.240.726.23 |
| ** | 2530233017729 | 10.R3200E |
| 115 | 2530233019106 | 06.R559120 |
| 95 | 2530233020377 | 04.R631010 |
| 107 | 2530233030184 | 05.700000 |
| 90 | 2530233037766 | 04.R631009 |
| 96 | 2530233037826 | 04.4234.00 |
| 185 | 2530233081623 | 10.511000 |
| 181 | 2530233084591 | 10.R5210 |
| 91 | 2530233102024 | 04.240.726.21 |
| 19 | 2530233131245 | 01.1200.35 |

| Pág. | NATO | AIR-FREN |
|------|---------------|------------|
| 115 | 2530233144046 | 06.559120 |
| 121 | 2530233145605 | 07.7020.90 |
| 82 | 2530233148460 | 03.3070.10 |
| 97 | 2530233160083 | 04.4225.00 |
| 67 | 2530233184531 | 02.2424.00 |
| 90 | 2530233184535 | 04.565590 |
| 104 | 2530233212589 | 05.2458.50 |
| 107 | 2530233225314 | 05.714000 |
| 96 | 2530233226904 | 04.4224.00 |
| 185 | 2530233230306 | 10.5018.10 |
| 107 | 2530233252321 | 05.R700403 |
| ** | 2530233252321 | 11.R2959 |
| 161 | 2530233253715 | 10.410106 |
| 94 | 2530233254182 | 04.4215.00 |
| 102 | 2530233255096 | 05.545021 |
| 96 | 2530233255355 | 04.R631008 |
| 177 | 2530233262790 | 10.559005 |
| 208 | 2530233269792 | 11.R2957 |
| 173 | 2530233271617 | 10.9640.00 |
| 96 | 2530233281713 | 04.4224.50 |
| 195 | 2530233295327 | 10.432407 |
| 94 | 2530233300343 | 04.R4214 |
| 94 | 2530233309119 | 04.4217.00 |
| 84 | 2530233334304 | 03.527018 |
| 67 | 2530233335475 | 02.2424.00 |
| 121 | 2530233358314 | 07.561008 |
| 149 | 2590123160454 | 09.051.124 |
| 149 | 2590233160454 | 09.051.124 |
| 175 | 3040121550651 | 10.1883.50 |
| 141 | 3040123306996 | 09.051.114 |
| 141 | 3040233306996 | 09.051.114 |
| 54 | 4310123147467 | 01.391.200 |
| 54 | 4310233147467 | 01.391.200 |
| 290 | 4730121646916 | 14.7031.00 |
| 191 | 4730121753426 | 10.579013 |
| 290 | 4730211646916 | 14.7031.00 |
| 191 | 4730211753426 | 10.579013 |
| 172 | 4810121633460 | 10.4720.00 |
| 173 | 4810121668444 | 10.0030.04 |
| 173 | 4810121808236 | 10.0030.04 |
| 172 | 4810211633460 | 10.4720.00 |
| 173 | 4810211808236 | 10.0030.04 |
| 183 | 4820121656094 | 10.3200.60 |
| 129 | 4820123143762 | 08.933.492 |
| 130 | 4820123205799 | 08.3032.00 |
| 135 | 4820123205799 | 08.3111.00 |
| 183 | 4820211656094 | 10.3200.60 |
| 129 | 4820233143762 | 08.933.492 |
| 163 | 6150123318744 | 10.410100 |
| 163 | 6150233318744 | 10.410100 |

NEOPLAN

| Pág. | NEOPLAN | AIR-FREN |
|------|-----------|------------|
| 312 | 010111006 | 17.460.020 |
| 173 | 010866400 | 10.2001.00 |
| 313 | 040111610 | 17.460.040 |
| 309 | 040117200 | 17.430.015 |
| 311 | 040119200 | 17.450.030 |
| 145 | 040320400 | 09.051.111 |
| 311 | 042150900 | 17.450.025 |
| 144 | 042320200 | 09.051.126 |
| 152 | 042321100 | 09.051.176 |

| Pág. | NEOPLAN | AIR-FREN |
|------|---------------|-------------|
| 67 | 070215300 | 02.3630.00 |
| 102 | 071100000 | 05.9710.00 |
| 179 | 071270000 | 10.543012 |
| 104 | 071280000 | 05.2458.50 |
| 186 | 071310000 | 10.5031.10 |
| 107 | 07143.000 | 05.714000 |
| 131 | 102140000 | 08.4410.60 |
| 173 | 108664000 | 10.2001.00 |
| 312 | 110000330 | 17.460.030 |
| 309 | 110097340 | 17.430.015 |
| 312 | 110100390 | 17.460.015 |
| 323 | 110140500 | 18.R650.070 |
| 131 | 110165210 | 08.4410.60 |
| 107 | 110173440 | 05.714000 |
| 129 | 110174110 | 08.222.703 |
| 107 | 1102.457.00 | 05.714000 |
| 82 | 110240300 | 03.105510 |
| 82 | 1102403543901 | 03.105510 |
| 107 | 110245400 | 05.700000 |
| 172 | 1102523543703 | 10.4720.00 |
| 172 | 1102523543706 | 10.R4720 |
| 173 | 110252600 | 10.4750.00 |
| 97 | 1102661544012 | 04.4225.00 |
| 129 | 110269300 | 08.222.703 |
| 161 | 110273401 | 10.410106 |
| 185 | 110273410 | 10.511000 |
| 185 | 110293200 | 10.5018.10 |
| 95 | 112232900 | 04.4219.00 |
| 322 | 1448913 | 18.R650.005 |
| 172 | 240612301 | 10.R4720 |
| 172 | 240612400 | 10.4730.00 |
| 172 | 240612450 | 10.R4730 |
| 311 | 42151500 | 17.450.015 |

NEWAY

| Pág. | NEWAY | AIR-FREN |
|------|----------|------------|
| 138 | 90054007 | 08.8718.00 |
| 188 | 90554107 | 10.9055.00 |
| ** | 90554266 | 90554266 |
| 98 | 910014 | 04.4233.00 |
| 98 | 910058 | 04.4232.00 |

NISSAN

| Pág. | NISSAN | AIR-FREN |
|------|------------|---------------|
| 89 | 0066005491 | 04.240.726.18 |
| 178 | 0522171 | 10.543002 |
| 178 | 0522171 | 10.543002 |
| 184 | 0522392 | 10.5676.00 |
| 182 | 066004430 | 10.4395.10 |
| 82 | 066004790 | 03.105508 |
| 107 | 066005410 | 05.6120.40 |
| 90 | 066005491 | 04.240.726.16 |
| 89 | 066005500 | 04.240.726.5 |
| 89 | 066005520 | 04.240.726.19 |
| 79 | 066010430 | 03.1900.30 |
| 197 | 066011260 | 10.2670.12 |
| 183 | 0661491 | 10.2440.15 |
| 183 | 0661501 | 10.4375.10 |
| 89 | 0663680 | 04.240.726.19 |
| 197 | 067001162 | 10.2670.12 |

| Pág. | NISSAN | AIR-FREN |
|------|-----------|----------------|
| 70 | 069004120 | 02.R9000E |
| 89 | 069004870 | 04.R240.726.00 |
| 212 | 069021170 | 11.R3150 |
| 178 | 069023640 | 10.R3350 |
| 79 | 069025580 | 03.R1900 |
| 125 | 069026070 | 07.R3550 |
| 212 | 119004590 | 11.R4150 |
| 144 | 163003590 | 09.051.102P |
| 62 | 5109FF5 | 01.2760.40 |
| 61 | 992107 | 01.7000.10 |
| 9 | 995472 | 01.1100.20 |
| 9 | 995669 | 01.1500.10 |
| 9 | 996346 | 01.1500.10 |
| 11 | 996692 | 01.230.303.0 |
| 89 | FD4566 | 04.240.726.8 |
| 197 | IHD4229 | 10.7010.10 |
| 182 | S103FF5 | 10.3450.10 |
| 182 | S12225 | 10.R3450 |
| 125 | X50076 | 07.3500.30 |

OMP

| Pág. | OMP | AIR-FREN |
|------|---------|------------|
| 215 | 1405020 | 12.350.010 |
| 219 | 196070 | 12.360.040 |
| 219 | 196251 | 12.360.035 |
| 220 | 196293 | 12.360.080 |
| 218 | 196319 | 12.360.015 |
| 220 | 196342 | 12.360.065 |
| 220 | 196347 | 12.360.100 |
| 219 | 196436 | 12.360.045 |
| 219 | 196438 | 12.360.050 |
| 218 | 196445 | 12.360.030 |
| 219 | 196446 | 12.360.085 |
| 219 | 196447 | 12.360.070 |
| 218 | 196460 | 12.360.010 |
| 219 | 196485 | 12.360.055 |
| 220 | 196549 | 12.360.095 |
| 219 | 196633 | 12.360.075 |
| 220 | 196634 | 12.360.080 |
| 218 | 196650 | 12.360.025 |
| 218 | 196670 | 12.360.010 |
| 220 | 196672 | 12.360.060 |
| 220 | 196750 | 12.360.090 |
| 218 | 206265 | 12.360.020 |
| 220 | 216278 | 12.360.060 |
| 219 | 216419 | 12.360.075 |
| 220 | 216568 | 12.360.090 |
| 234 | 241700 | 12.380.095 |
| 230 | 241800 | 12.380.025 |
| 233 | 241820 | 12.380.075 |
| 231 | 241825 | 12.380.040 |
| 231 | 241835 | 12.380.045 |
| 234 | 241855 | 12.380.100 |
| 234 | 241860 | 12.380.090 |
| 233 | 241875 | 12.380.070 |
| 233 | 241895 | 12.380.080 |
| 230 | 241900 | 12.380.010 |
| 230 | 241935 | 12.380.015 |
| 230 | 241940 | 12.380.020 |
| 232 | 241950 | 12.380.055 |
| 232 | 241960 | 12.380.060 |
| 231 | 241965 | 12.380.030 |



| Pág. | OMP | AIR-FREN |
|------|--------|---------------|
| 233 | 241970 | 12.380.085 |
| 231 | 241975 | 12.380.035 |
| 232 | 241980 | 12.380.065 |
| 232 | 241995 | 12.380.050 |
| 231 | 242181 | 12.R380.040 |
| 230 | 242230 | 12.R380.020 |
| 232 | 242237 | 12.R380.065 |
| 231 | 242248 | 12.R380.030 |
| 231 | 242249 | 12.R380.035 |
| 232 | 242265 | 12.R380.050 |
| ** | 273100 | 12.400.010 |
| 244 | 273110 | 12.400.015 |
| 244 | 273120 | 12.400.020 |
| 244 | 273130 | 12.400.035 |
| ** | 273300 | 12.400.025 |
| ** | 273340 | 12.400.040 |
| 244 | 273345 | 12.400.020 |
| ** | 273350 | 5010258977 |
| ** | 273370 | 12.400.030 |
| 248 | 292131 | 12.R410.015.2 |
| 248 | 292132 | 12.R410.015.1 |
| 248 | 292143 | 12.R410.020.1 |
| 249 | 292198 | 12.R410.045.1 |
| 249 | 292199 | 12.R410.030.1 |
| 249 | 292200 | 12.R410.045.2 |
| 248 | 292201 | 12.R410.025.1 |
| 248 | 295010 | 12.410.015 |
| 249 | 295020 | 12.410.030 |
| 248 | 295035 | 12.410.020 |
| 248 | 295050 | 12.410.010 |
| 249 | 295060 | 12.410.035 |
| 249 | 295070 | 12.410.040 |
| 248 | 295100 | 12.410.025 |
| 249 | 295110 | 12.410.045 |
| 250 | 295120 | 12.410.050 |
| 250 | 295130 | 12.410.055 |
| 250 | 295140 | 12.410.060 |
| 252 | 312171 | 12.R420.015 |
| 252 | 312172 | 12.R420.010 |
| 253 | 312175 | 12.R420.035 |
| 252 | 312276 | 12.R420.015 |
| 253 | 312278 | 12.R420.040 |
| 252 | 312285 | 12.R420.010 |
| 253 | 317010 | 12.420.030 |
| 252 | 317060 | 12.420.010 |
| 252 | 317070 | 12.420.025 |
| 252 | 317160 | 12.420.015 |
| 252 | 317170 | 12.420.020 |
| 254 | 317175 | 12.420.075 |
| 253 | 317180 | 12.420.045 |
| 253 | 317190 | 12.420.035 |
| 252 | 317215 | 12.420.010 |
| 252 | 317220 | 12.420.020 |
| 252 | 317225 | 12.420.025 |
| 253 | 317230 | 12.420.030 |
| 253 | 317240 | 12.420.040 |
| 254 | 317250 | 12.420.060 |
| 254 | 317270 | 12.420.070 |
| 254 | 317310 | 12.420.065 |
| 254 | 317320 | 12.420.055 |
| 232 | 342162 | 12.R380.065 |
| 223 | 342238 | 12.R370.010 |
| 223 | 342241 | 12.R370.015 |
| 223 | 343260 | 12.370.030 |

| Pág. | OMP | AIR-FREN |
|------|--------|-------------|
| 224 | 343265 | 12.370.035 |
| 232 | 343265 | 12.380.060 |
| 223 | 343280 | 12.370.010 |
| 223 | 343310 | 12.370.015 |
| 223 | 343320 | 12.370.020 |
| 224 | 343330 | 12.370.055 |
| 224 | 343345 | 12.370.045 |
| 224 | 343350 | 12.370.050 |
| 226 | 343355 | 12.370.095 |
| 224 | 343360 | 12.370.060 |
| 226 | 343365 | 12.370.090 |
| 225 | 343370 | 12.370.080 |
| 225 | 343375 | 12.370.075 |
| 215 | 405055 | 12.350.015 |
| 215 | 405060 | 12.350.020 |
| 216 | 405070 | 12.350.035 |
| 215 | 405075 | 12.350.025 |
| 216 | 405080 | 12.350.030 |
| 216 | 405085 | 12.350.050 |
| 216 | 405100 | 12.350.040 |
| 216 | 405274 | 12.R350.035 |
| 215 | 405275 | 12.R350.025 |
| 216 | 405276 | 12.R350.030 |
| 215 | 405277 | 12.R350.015 |
| 216 | 405285 | 12.R350.040 |

ORTHAUS

| Pág. | ORTHAUS | AIR-FREN |
|------|-------------|------------|
| 107 | 49500021000 | 05.714000 |
| 108 | 49500111001 | 05.557006 |
| 130 | 49500451002 | 08.8010.40 |
| 186 | 49500721001 | 10.5031.10 |
| 173 | 49500801000 | 10.9640.00 |
| 130 | 49530201000 | 08.3032.00 |
| 135 | 49530201000 | 08.3111.00 |
| 131 | 51809030000 | 08.4410.60 |

RENAULT

| Pág. | RENAULT | AIR-FREN |
|------|------------|----------------|
| 290 | 0000719578 | 14.7031.00 |
| 181 | 0000719769 | 10.5210.10 |
| 244 | 0000773983 | 12.400.020 |
| 316 | 0001140427 | 17.470.030 |
| 309 | 0001141035 | 17.430.015 |
| 115 | 0003299009 | 06.R639008 |
| 181 | 0003299012 | 10.R5210 |
| 101 | 0003299037 | 05.R645013 |
| 71 | 0003352071 | 02.1636L |
| 90 | 0022095400 | 04.240.726.4 |
| ** | 0022170000 | 10.2700.10 |
| 10 | 0022321200 | 01.2320.90 |
| 90 | 0022721200 | 04.R240.726.41 |
| 197 | 0022734400 | 10.R4050 |
| 79 | 0022734800 | 03.R1900 |
| 212 | 0022778400 | 11.R3150 |
| ** | 0022857500 | 01.4405 |
| ** | 0022857600 | 01.4410 |
| ** | 0022858500 | 14.4052 |
| 191 | 0022868600 | 10.3500.22A |
| 191 | 0022868700 | 10.3500.22R |

| Pág. | RENAULT | AIR-FREN |
|------|------------|---------------|
| 12 | 0022972000 | 01.3005.00 |
| 11 | 0022972100 | 01.1150.90 |
| 12 | 0022987900 | 01.3005.20 |
| 191 | 0023014200 | 10.579004 |
| 191 | 0023014300 | 10.579003 |
| 89 | 0023025600 | 04.240.726.6 |
| ** | 0023124536 | 5002528 |
| ** | 0023140736 | 5000271 |
| 178 | 0023170600 | 10.930.930 |
| 316 | 0023618122 | 17.470.030 |
| ** | 0023895400 | 5835 |
| 123 | 0024081000 | 07.045522 |
| 90 | 0024515900 | 04.240.726.10 |
| 183 | 0024624008 | 10.4375.10 |
| 101 | 0024733006 | 05.575537 |
| 191 | 0037534600 | 10.579001 |
| 182 | 0060211800 | 10.2950.20 |
| 198 | 0060225700 | 10.2405.55 |
| 89 | 0060376300 | 04.240.726.3 |
| 196 | 0060394600 | 10.2650.10 |
| 11 | 0060433000 | 01.1150.90 |
| 79 | 0060691200 | 03.1900.10 |
| 74 | 0062521200 | 02.1831.91 |
| 72 | 0062521500 | 02.R9000N |
| ** | 0062531600 | 01.1150.62 |
| 72 | 0063057500 | 02.R1650 |
| ** | 0063064000 | 01.R1150 |
| ** | 0063068100 | 10.4295 |
| 212 | 0063068300 | 11.R2950 |
| 178 | 0063118600 | 10.R3350 |
| ** | 0063123700 | 01.4265 |
| ** | 0063123800 | 01.3081.37 |
| 72 | 0063194900 | 02.R1800 |
| 70 | 0063203700 | 02.R1800E |
| 196 | 0063220900 | 10.R2650 |
| 197 | 0063224200 | 10.R4000 |
| ** | 0063224600 | 2100 |
| ** | 0063237400 | 10.R2700 |
| ** | 0063243700 | 01.4260 |
| ** | 0063283600 | 01.R1100 |
| 197 | 0064003700 | 10.7010.70 |
| 197 | 0064007700 | 10.7010.60 |
| 11 | 063846600 | 01.230.301.7 |
| 17 | 1119046 | 01.1200.20 |
| 141 | 1120353 | 09.R051.114 |
| ** | 4010071580 | 4310 |
| 61 | 4010889540 | 01.7000.10 |
| ** | 4011307310 | 01.1100.21 |
| 9 | 4011313560 | 01.1100.90 |
| ** | 4011315940 | 4460 |
| ** | 4011316040 | 1053 |
| ** | 4011316140 | 1054 |
| ** | 4011316240 | 4465 |
| ** | 4011317140 | 1051 |
| ** | 4020823140 | 5000250 |
| ** | 4020823340 | 4101 |
| ** | 4020823740 | 5000154 |
| ** | 4020823840 | 5000200 |
| 289 | 4020826040 | 14.4710 |
| ** | 4020950640 | 5000159 |
| ** | 4021046920 | 01.1024.44 |
| ** | 4021058130 | 01.1100.25 |
| ** | 4021071250 | 14.1953 |
| 285 | 4021072140 | 14.4315 |

| Pág. | RENAULT | AIR-FREN |
|------|------------|------------|
| ** | 4021127240 | 02.1407.45 |
| ** | 4021450540 | 02.1401 |
| ** | 4021738640 | 2019 |
| ** | 4022145540 | 4169 |
| ** | 4022422930 | 5002502 |
| ** | 4022507040 | 5002022 |
| ** | 4033010440 | 4285 |
| ** | 4033011140 | 4500 |
| ** | 4033012340 | 4320 |
| ** | 4033012440 | 4325 |
| ** | 4033013440 | 4300 |
| ** | 4033017540 | 4380 |
| ** | 4033021140 | 14.2021 |
| ** | 4033023340 | 3958 |
| ** | 4033023440 | 2208 |
| ** | 4033062140 | 4350 |
| ** | 4033071540 | 4290 |
| ** | 4033079340 | 1052 |
| ** | 4033100810 | 01.2807 |
| ** | 4033100910 | 01.4245 |
| ** | 4033101510 | 3010-14 |
| ** | 4033102610 | 01.4230 |
| ** | 4033103110 | 01.1150.67 |
| ** | 4033103210 | 01.1150.68 |
| ** | 4033146040 | 4335 |
| ** | 4033148340 | 3960 |
| ** | 4033153240 | 3959 |
| 182 | 4033184240 | 10.R3800E |
| 198 | 4033184440 | 10.R3300 |
| 212 | 4033184940 | 11.R4150 |
| ** | 4033191840 | 01.2320.48 |
| 72 | 4033195540 | 02.R1600 |
| 182 | 4033195640 | 10.R3450 |
| 196 | 4033195840 | 10.R2550 |
| 75 | 4033195940 | 02.R1400 |
| 75 | 4033196040 | 02.R1350 |
| 125 | 4033196240 | 07.R3500 |
| 211 | 4033196340 | 11.R3750 |
| ** | 4033196740 | 11.R2200 |
| 75 | 4033196840 | 02.R1750 |
| 125 | 4033197340 | 07.R3550 |
| 75 | 4033197840 | 02.R1500 |
| ** | 4033197940 | 11.R2050 |
| ** | 4033228140 | 1600-91 |
| 71 | 4033229440 | 02.1651 |
| 74 | 4033231840 | 02.9000.91 |
| 71 | 4033232040 | 02.1802 |
| 71 | 4033232140 | 02.1651 |
| ** | 4033236340 | 01.4220 |
| ** | 4033236440 | 01.4225 |
| 70 | 4033238040 | 02.R9000 |
| 196 | 4033254240 | 10.R2250 |
| 15 | 4800061300 | 01.1024.70 |
| 15 | 4800061400 | 01.1024.80 |
| 10 | 4800077610 | 01.1150.00 |
| 11 | 4800105210 | 01.1150.60 |
| 62 | 4811025922 | 01.4070.10 |
| 9 | 4811091860 | 01.1100.20 |
| 9 | 4811365810 | 01.1100.60 |
| 15 | 4811391110 | 01.1024.40 |
| 15 | 4811416310 | 01.1024.50 |
| 9 | 4811416310 | 01.1100.50 |
| 15 | 4811449910 | 01.1024.90 |
| 198 | 4820018780 | 10.3300.10 |

CRUCE DE REFERENCIAS: REFERENCIAS ORIGINALES / AIR FREN

CROSS REFERENCE LIST: ORIGINAL REFERENCES / AIR FREN

| Pág. | RENAULT | AIR-FREN | Pág. | RENAULT | AIR-FREN | Pág. | RENAULT | AIR-FREN | Pág. | RENAULT | AIR-FREN |
|------|-------------|---------------|------|------------|---------------|------|------------|-------------|------|---------------|----------------|
| 182 | 4820058180 | 10.4395.10 | 148 | 5000673435 | 09.244.402 | ** | 5001011261 | 01.1150.62 | 267 | 5010260118 | 13.69078 |
| 75 | 4820364120 | 02.1350.20 | 171 | 5000673571 | 10.6735.00 | 196 | 5001011262 | 10.R2650 | 94 | 501026013180 | |
| 125 | 4820373920 | 07.3500.30 | 309 | 5000677075 | 17.430.010 | ** | 5001011263 | 01.4220 | | tapón boca 22 | 04.4216.00 |
| 62 | 4820378020 | 01.2760.60 | 315 | 5000677276 | 17.470.015 | 11 | 5001011279 | 01.1150.90 | 244 | 5010323187 | 12.400.020 |
| 62 | 4820390820 | 01.2760.40 | ** | 5000681283 | 12.400.040 | ** | 5001011280 | 4102 | ** | 5010422396 | LA-8041 |
| ** | 4820821430 | 05.3750.00 | 96 | 5000716328 | 04.4222.00 | 125 | 5001011281 | 07.R3550 | ** | 5010422396 | LA-8065 |
| 183 | 4820827440 | 10.4375.10 | ** | 5000787082 | SV-3115 | 197 | 5001011282 | 10.7010.40 | ** | 5010422971 | AE-4605 |
| 198 | 4821171940 | 10.1950.10 | ** | 5000787083 | SV-1280 | 315 | 5001825649 | 17.470.020 | 183 | 5010446105 | 10.8321.00 |
| 125 | 4821338420 | 07.3550.20 | 267 | 5000787264 | 13.62005 | 316 | 5001825649 | 17.470.035 | ** | 5010452512 | 970.051.422.0 |
| 101 | 4821352510 | 05.545003 | 267 | 5000787265 | 13.62006 | 156 | 5001834842 | 09.626.159 | ** | 5010525808 | AE-4525 |
| 197 | 4821539010 | 10.7010.10 | 96 | 5000787418 | 04.4222.00 | 314 | 5001836993 | 17.460.075 | 186 | 5021170125 | 10.4410.40 |
| 101 | 4821633610 | 05.545003 | 315 | 5000787645 | 17.470.015 | ** | 5001843640 | 3R2604130 | 186 | 5021170126 | 10.4410.100 |
| 197 | 4821635410 | 10.7010.40 | 315 | 5000787647 | 17.470.015 | 148 | 5001843783 | 09.R244.402 | 131 | 5021170128 | 08.4410.70 |
| 75 | 4821689120 | 02.1500.30 | 149 | 5000787875 | 09.051.124 | 148 | 5001843793 | 09.R245.752 | 131 | 5021170129 | 08.4410.60 |
| 183 | 4821723940 | 10.3200.30 | 267 | 5000789894 | 13.62162 | 148 | 5001843797 | 09.R244.224 | 129 | 5021170185 | 08.4640.00 |
| 178 | 4821966920 | 10.543002 | 267 | 5000789895 | 13.62163 | 310 | 5001858682 | 17.440.010 | 186 | 5021170197 | 10.5031.00 |
| 183 | 4822010840 | 10.2440.15 | 185 | 5000790124 | 10.5018.10 | 310 | 5001864270 | 17.440.010 | 185 | 5021170198 | 10.5040.00 |
| 75 | 4822026120 | 02.1400.10 | 173 | 5000791020 | 10.9640.00 | 309 | 5001866623 | 17.430.010 | 208 | 5021170251 | 11.R2958 |
| 182 | 4822133640 | 10.2950.90 | 129 | 5000791021 | 08.933.492 | 309 | 5001866625 | 17.430.010 | 91 | 5021170417 | 04.240.726.21 |
| 182 | 4822189930 | 10.3450.10 | 183 | 5000791040 | 10.8321.10 | 310 | 5001873287 | 17.440.010 | 104 | 5021170425 | 05.2458.51 |
| 196 | 4822199130 | 10.2250.70 | 267 | 5000791212 | 13.62318 | 121 | 5010019862 | 07.561009 | 104 | 5021170428 | 05.2458.50 |
| ** | 4822407940 | 10.2400.12 | 267 | 5000791213 | 13.62319 | 185 | 5010037206 | 10.511000 | 104 | 5021170439 | 05.557007 |
| 198 | 4822422140 | 10.2400.13 | 137 | 5000791228 | 08.004201 | 94 | 5010056094 | 04.4214.00 | 102 | 5021170458 | 05.545021 |
| 182 | 4822431330 | 10.2950.10 | 156 | 5000792359 | 09.623.106 | 267 | 5010056685 | 13.62160 | 105 | 5021170462 | 05.009300 |
| 182 | 4822431430 | 10.2950.00 | 184 | 5000806404 | 10.1881.10 | 267 | 5010056686 | 13.62161 | 123 | 54300004116 | 07.R661001 |
| 75 | 4864605993 | 02.1750.20 | 311 | 5000807806 | 17.450.020 | 267 | 5010098831 | 13.62740 | 143 | 5430000717 | 09.051.107P |
| 91 | 5000027604 | 04.240.726.25 | 315 | 5000807806 | 17.470.010 | 267 | 5010098832 | 13.62741 | 65 | 5430003105 | 02.239.024.1C |
| 315 | 5000028321 | 17.470.015 | 84 | 5000807916 | 03.527018 | 267 | 5010098860 | 13.62798 | 70 | 5430003499 | 02.1800.00 |
| 309 | 5000058221 | 17.430.010 | 125 | 5000807962 | 07.R1335 | 267 | 5010098860 | 13.69294 | 11 | 5430004144 | 01.230.301.7 |
| 92 | 5000121753 | 04.240.726.26 | 90 | 5000809069 | 04.R631009 | 267 | 5010098861 | 13.62799 | 191 | 5430004381 | 10.579005 |
| 92 | 5000121753 | 04.240.726.31 | 309 | 5000809155 | 17.430.010 | 267 | 5010098861 | 13.69295 | 191 | 5430004382 | 10.579006 |
| 92 | 5000121756 | 04.240.726.27 | 157 | 5000809514 | 09.715.607 | 267 | 5010098862 | 13.62813 | 89 | 5430008914 | 04.240.726.18 |
| 277 | 50001825536 | 13.66046 | ** | 5000811135 | 01.391.400.1 | 267 | 5010098863 | 13.62814 | 129 | 5430011260 | 08.222.703 |
| 309 | 5000240864 | 17.430.010 | 67 | 5000811230 | 02.2424.00 | ** | 5010135142 | T-1357 | 90 | 5430014213 | 04.240.726.16 |
| 121 | 5000241771 | 07.561007 | 208 | 5000811786 | 11.R2958 | 132 | 5010136105 | 08.8010.80 | 70 | 5430018141 | 02.1800.30 |
| 309 | 5000251362 | 17.430.030 | 208 | 5000811790 | 11.R2958 | 94 | 5010145720 | 04.4214.00 | 70 | 5430018142 | 02.9000.30 |
| 193 | 5000289827 | 10.R4510 | 208 | 5000814513 | 11.R2958 | 93 | 5010145721 | 04.4213.00 | ** | 5430018410 | 237.075.3 |
| 201 | 5000289847 | 11.R2905 | 208 | 5000814514 | 11.R2958 | 267 | 5010145883 | 13.62738 | 106 | 5430032079 | 05.533005 |
| 202 | 5000295454 | 11.R2914 | 149 | 5000814530 | 09.R051.209 | 267 | 5010145884 | 13.62739 | 155 | 543004214 | 09.1883.60 |
| ** | 5000338059 | 12.400.010 | 85 | 5000814826 | 03.R527024 | 195 | 5010151348 | 10.432407 | 185 | 5430042384 | 10.5018.10 |
| 91 | 5000439781 | 04.240.726.22 | 143 | 5000814928 | 09.R051.107 | ** | 5010197578 | 13.62994 | 89 | 543004280 | 04.R240.726.00 |
| 67 | 5000445893 | 02.2424.00 | 144 | 5000815689 | 09.051.126 | 267 | 5010216246 | 13.62786 | 209 | 5430052902 | 11.R2961 |
| 67 | 5000446230 | 02.2424.00 | 54 | 5000816054 | 01.391.200 | 267 | 5010216247 | 13.62787 | ** | 5430120067 | 230.300.82.004 |
| 173 | 5000455080 | 10.0030.04 | 161 | 5000819872 | 10.1867.10 | 267 | 5010216843 | 13.62835 | 70 | 5430120089 | 02.R1800M |
| 173 | 5000455081 | 10.0030.02 | 315 | 5000819904 | 17.470.015 | 267 | 5010216844 | 13.62836 | 70 | 5430120090 | 02.R9000E |
| 309 | 5000456367 | 17.430.020 | 315 | 5000821016 | 17.470.015 | 131 | 5010231137 | 08.4410.60 | ** | 5430120333 | 01.1150.61 |
| 95 | 5000504490 | 04.4221.00 | 316 | 5000821330 | 17.470.030 | 156 | 5010241357 | 09.624.248 | ** | 5430120939 | 5002519 |
| 115 | 5000514869 | 06.559160 | 173 | 5000822201 | 10.4750.00 | 316 | 5010244017 | 17.470.040 | ** | 5430120940 | 259.206.0 |
| 91 | 5000544905 | 04.240.726.21 | 163 | 5000822202 | 10.410100 | 315 | 5010244086 | 17.470.025 | 198 | 5430120953 | 10.235.030.0 |
| 91 | 5000544905 | 04.240.726.21 | 203 | 5000822650 | 11.R2915 | 316 | 5010244202 | 17.470.040 | ** | 5430120975 | 01.3011.07 |
| 70 | 5000560850 | 02.2070.00 | 95 | 5000823245 | 04.R631010 | 315 | 5010244204 | 17.470.025 | ** | 5430129265 | 7010-61 |
| 183 | 5000588186 | 10.R8321 | 107 | 5000824502 | 05.R711000 | 149 | 5010244208 | 09.625.384 | ** | 5430129527 | 235.024.0 |
| 141 | 5000589133 | 09.051.114 | 315 | 5000835199 | 17.470.015 | 149 | 5010244209 | 09.627.612 | 267 | 5430260288 | 13.69683 |
| 172 | 5000589859 | 10.4720.00 | 91 | 5000873223 | 04.240.726.22 | 148 | 5010244223 | 09.244.402 | 267 | 5430260289 | 13.69684 |
| 178 | 5000590308 | 10.R430527 | 156 | 5000877187 | 09.623.104 | 148 | 5010244224 | 09.244.224 | 191 | 5516017524 | 10.579013 |
| 107 | 5000590347 | 05.R700403 | 156 | 5000877188 | 09.623.105 | 148 | 5010244402 | 09.244.402 | 309 | 5516021267 | 17.430.010 |
| ** | 5000590347 | 11.R2959 | 105 | 5001000141 | 05.R657000 | 148 | 5010245752 | 09.245.752 | 107 | 5600528058 | 05.700000 |
| 172 | 5000590379 | 10.R4720 | 174 | 5001001105 | 10.R1880 | 94 | 5010251112 | 04.4214.00 | 107 | 5600528258 | 05.700000 |
| 309 | 5000613650 | 17.430.010 | 311 | 5001001622 | 17.450.025 | ** | 5010258978 | 12.400.030 | 311 | 5800207033 | 17.450.025 |
| 122 | 5000646901 | 07.7020.70 | 311 | 5001001623 | 17.450.030 | 267 | 5010260027 | 13.62997 | 66 | 5810111369 | 02.1612.20 |
| 244 | 5000663009 | 12.400.015 | ** | 5001010690 | 01.1150.63 | 267 | 5010260028 | 13.62998 | 290 | 719578 | 14.7031.00 |
| ** | 5000663121 | 12.400.025 | ** | 5001010691 | 01.1150.64 | 267 | 5010260115 | 13.69308 | 208 | 7701012291 | 11.R2958 |
| 244 | 5000670157 | 12.400.035 | ** | 5001011248 | 01.4225 | 267 | 5010260116 | 13.69309 | 102 | 7701012770 | 05.545023 |
| 149 | 5000673126 | 09.051.209 | 196 | 5001011260 | 10.2650.10 | 267 | 5010260117 | 13.69077 | ** | 7701363587 | 10.4375.00 |



| Pág. RENAULT | AIR-FREN |
|---------------|------------|
| ** 7701363591 | 01.1150.63 |
| ** 7701363592 | 01.1150.64 |
| ** 7701363593 | 01.4615 |

RITEC

| Pág. RITEC | AIR-FREN |
|-----------------|------------|
| 82 49800037900 | 03.3070.10 |
| 130 49800049000 | 08.8010.40 |
| 129 49800052400 | 08.933.492 |

ROR

| Pág. ROR | AIR-FREN |
|---------------|--------------|
| 276 1362788 | 13.62788 |
| 306 21200321 | 16.7190.00 |
| 306 21200321B | 16.7190.40 |
| 306 21220158 | 16.7190.10 |
| 66 41225767 | 02.239.024.6 |
| 69 41227563 | 02.2424.50 |
| 325 MCK1238G | 18.R850.010 |
| 325 MCK1238 | 18.R850.020 |

SACHS

| Pág. SACHS | AIR-FREN |
|----------------|------------|
| 309 1851117201 | 17.430.020 |
| 309 1851151001 | 17.430.010 |
| 315 1897377330 | 17.470.015 |
| 313 3100000003 | 17.460.050 |
| 318 3100002112 | 17.490.015 |
| 318 3100002114 | 17.490.020 |
| 318 3100002118 | 17.490.015 |
| 315 3100002121 | 17.470.015 |
| 318 3100002218 | 17.490.015 |
| 318 3100002218 | 17.490.025 |
| 318 3100002220 | 17.490.015 |
| 318 3100002220 | 17.490.025 |
| 318 3100002247 | 17.490.020 |
| 318 3100002247 | 17.490.030 |
| 313 3100002254 | 17.460.050 |
| 313 3100002255 | 17.460.045 |
| 317 3100008001 | 17.480.010 |
| 317 3100008101 | 17.480.010 |
| 315 3100008106 | 17.470.015 |
| 317 3100008201 | 17.480.010 |
| 318 3100026432 | 17.490.020 |
| 318 3100026433 | 17.490.015 |
| 318 3100026433 | 17.490.025 |
| 309 3151000034 | 17.430.035 |
| 311 3151000034 | 17.450.040 |
| 310 3151000144 | 17.440.010 |
| 317 3151000151 | 17.480.025 |
| 314 3151000335 | 17.460.060 |
| 312 3151000375 | 17.460.030 |
| 312 3151000392 | 17.460.025 |
| 311 3151000395 | 17.450.015 |
| 315 3151000404 | 17.470.025 |
| 309 3151007303 | 17.430.015 |
| 309 3151015101 | 17.430.010 |
| 309 3151015301 | 17.430.010 |

| Pág. SACHS | AIR-FREN |
|----------------|------------|
| 309 3151015332 | 17.430.010 |
| 309 3151023101 | 17.430.020 |
| 312 3151027131 | 17.460.030 |
| 311 3151028001 | 17.450.025 |
| 312 3151043032 | 17.460.025 |
| 309 3151057001 | 17.430.030 |
| 309 3151057002 | 17.430.030 |
| 311 3151066002 | 17.450.030 |
| 311 3151066032 | 17.450.030 |
| 311 3151067001 | 17.450.025 |
| 311 3151067002 | 17.450.020 |
| 311 3151067031 | 17.450.025 |
| 311 3151067032 | 17.450.020 |
| 315 3151067032 | 17.470.010 |
| 309 3151101031 | 17.430.015 |
| 318 3151106041 | 17.490.010 |
| 313 3151108031 | 17.460.040 |
| 312 3151110031 | 17.460.020 |
| 313 3151126031 | 17.460.035 |
| 316 3151150041 | 17.470.030 |
| 311 3151152101 | 17.450.015 |
| 311 3151152102 | 17.450.015 |
| 309 3151153001 | 17.430.010 |
| 309 3151153002 | 17.430.010 |
| 309 3151157001 | 17.430.030 |
| 309 3151157002 | 17.430.030 |
| 309 3151157102 | 17.430.030 |
| 318 3151164333 | 17.490.025 |
| 309 3151169031 | 17.430.035 |
| 309 3151169131 | 17.430.035 |
| 309 3151169232 | 17.430.035 |
| 309 3151169332 | 17.430.035 |
| 311 3151169332 | 17.450.010 |
| 309 3151182102 | 17.430.025 |
| 309 3151182103 | 17.430.025 |
| 309 3151182203 | 17.430.025 |
| 309 3151182233 | 17.430.025 |
| 312 3151184031 | 17.460.015 |
| 313 3151184032 | 17.460.055 |
| 312 3151185031 | 17.460.010 |
| 309 3151199001 | 17.430.010 |
| 309 3151199002 | 17.430.010 |
| 310 3151203031 | 17.440.010 |
| 310 3151203031 | 17.440.020 |
| 310 3151225001 | 17.440.010 |
| 310 3151225001 | 17.440.020 |
| 310 3151225031 | 17.440.010 |
| 310 3151225031 | 17.440.020 |
| 315 3151234132 | 17.470.015 |
| 312 3151241031 | 17.460.015 |
| 313 3151241032 | 17.460.055 |
| 312 3151242031 | 17.460.010 |
| 312 3151245031 | 17.460.015 |
| 313 3151245032 | 17.460.055 |
| 312 3151246031 | 17.460.010 |
| 316 3151250231 | 17.470.040 |
| 315 3151250302 | 17.470.025 |
| 315 3151250332 | 17.470.025 |
| 313 3151258031 | 17.460.050 |
| 309 3151273431 | 17.430.035 |
| 314 3151273731 | 17.460.060 |
| 309 3151274831 | 17.430.030 |
| 311 3151280601 | 17.450.040 |
| 312 3151602002 | 17.460.030 |

| Pág. SACHS | AIR-FREN |
|----------------|------------|
| 312 3151602004 | 17.460.010 |
| 314 3180000001 | 17.460.065 |
| 315 3180000001 | 17.470.020 |
| 316 3180000001 | 17.470.035 |
| 318 3180001018 | 17.490.035 |
| 314 3180002102 | 17.460.065 |
| 315 3180002102 | 17.470.020 |
| 316 3180002102 | 17.470.035 |
| 314 3180002103 | 17.460.065 |
| 315 3180002103 | 17.470.020 |
| 316 3180002103 | 17.470.035 |
| 314 3180007101 | 17.460.070 |
| 318 3181001008 | 17.490.035 |
| 317 3182006131 | 17.480.020 |
| 317 3182006231 | 17.480.020 |
| 317 3182006531 | 17.480.020 |
| 317 3182009936 | 17.480.020 |
| 317 3182009938 | 17.480.020 |
| 314 3496006000 | 17.460.075 |

SAF

| Pág. SAF | AIR-FREN |
|-----------------|-------------|
| 324 3434381200 | 18.R750.030 |
| 324 3434381400 | 18.R750.005 |
| 276 4175008501 | 13.62250 |
| 276 4175024000 | 13.62250 |
| 322 5317002800 | 18.R650.005 |
| 323 84434371000 | 18.R650.080 |
| 323 85317001900 | 18.R650.070 |

SAUER

| Pág. SAUER | AIR-FREN |
|----------------|------------|
| 173 4425005300 | 10.9640.00 |
| 130 4425010400 | 08.8010.40 |
| 107 4425011700 | 05.714000 |
| 130 4425011900 | 08.3032.00 |
| 135 4425011900 | 08.3111.00 |
| 309 9532614001 | 17.430.015 |

SCANIA

| Pág. SCANIA | AIR-FREN |
|-------------|------------|
| 81 10571189 | 03.527006 |
| ** 1103236 | 20011 |
| ** 1103237 | 20012 |
| 71 1104202 | 02.1651 |
| 71 1104252 | 02.1601 |
| 49 1104991 | 01.1300.95 |
| 269 1108061 | 13.62690 |
| 269 1108062 | 13.62691 |
| 269 1112829 | 13.62620 |
| 269 1112830 | 13.62621 |
| 269 1112831 | 13.62622 |
| 269 1112832 | 13.62654 |
| 269 1112833 | 13.62624 |
| 269 1112833 | 13.62660 |
| 269 1112834 | 13.62625 |
| 269 1112834 | 13.62661 |
| 269 1112837 | 13.62628 |

| Pág. SCANIA | AIR-FREN |
|-------------|--------------|
| 269 1112838 | 13.62629 |
| 269 1112839 | 13.62630 |
| 269 1112840 | 13.62631 |
| 269 1112841 | 13.62654 |
| 153 1114685 | 09.361.136 |
| 138 1118884 | 08.8718.00 |
| 317 1123296 | 17.480.020 |
| 171 114160 | 10.3340.00 |
| 50 1300366 | 01.1200.150 |
| 45 1303226 | 01.1200.115 |
| 46 1303227 | 01.1200.120 |
| 71 1303474 | 02.1601L |
| 71 1303475 | 02.1651L |
| 65 1305774 | 02.239.020.1 |
| 185 1307040 | 10.5018.10 |
| 67 1313821 | 02.2424.00 |
| 65 1313833 | 02.239.020.1 |
| 195 1313854 | 10.432407 |
| 101 1313871 | 05.545004 |
| 80 1314047 | 03.527003 |
| 48 1314107 | 01.1200.140 |
| 248 1314406 | 12.410.020 |
| 209 1315172 | 11.R2961 |
| ** 1315279 | 20124 |
| ** 1315285 | A66RK029 |
| 36 1315372 | 01.391.550 |
| 170 1319557 | 10.3195.00 |
| 71 1320138 | 02.1802L |
| 317 1322781 | 17.480.010 |
| 33 1322813 | 01.391.450 |
| 81 1324662 | 03.527006 |
| 81 1324663 | 03.527006 |
| 49 1327231 | 01.1200.145 |
| 33 1327886 | 01.R110061 |
| 67 1331412 | 02.2424.00 |
| 149 1331770 | 09.1331.770 |
| 168 1332658 | 10.410200 |
| 171 1334037 | 10.3340.00 |
| 150 1337966 | 09.1337.966 |
| 131 1338343 | 08.4410.70 |
| 248 1338490 | 12.410.010 |
| 105 1338893 | 05.R009000 |
| 47 1348919 | 01.1200.125 |
| 48 1348920 | 01.1200.140 |
| 44 1349094 | 01.1200.210 |
| 187 1349840 | 10.4984.00 |
| 105 1350096 | 05.009010 |
| 102 1350118 | 05.545006 |
| 93 1350477 | 04.R4213 |
| 250 1353072 | 12.410.055 |
| 67 1353667 | 02.3030.00 |
| 248 1354103 | 12.410.025 |
| 180 1356634 | 10.5410.00 |
| 269 1358634 | 13.69033 |
| 269 1358635 | 13.69034 |
| 153 1358801 | 09.358.801 |
| 67 1358834 | 02.3030.00 |
| 153 1361136 | 09.361.136 |
| 150 136159 | 09.R360.717 |
| 249 1362261 | 12.410.045 |
| ** 1364636 | 10.R3540.00 |
| 250 1365841 | 12.410.060 |
| 150 1367453 | 09.625.359 |
| 161 1369763 | 10.410116 |

CRUCE DE REFERENCIAS: REFERENCIAS ORIGINALES / AIR FREN

CROSS REFERENCE LIST: ORIGINAL REFERENCES / AIR FREN

| Pág. | SCANIA | AIR-FREN |
|------|---------|---------------|
| 67 | 1372914 | 02.2424.00 |
| 249 | 1375838 | 12.410.035 |
| 249 | 1375839 | 12.410.045 |
| 161 | 1375997 | 10.1867.10 |
| ** | 1376280 | 01.R391.122.1 |
| ** | 1376281 | 01.R391.122.2 |
| 185 | 1376793 | 10.5018.00 |
| 248 | 1377571 | 12.410.010 |
| 131 | 1379941 | 08.4410.50 |
| ** | 1380455 | LP-4964 |
| 44 | 1380456 | 01.1200.210 |
| 43 | 1380457 | 01.1200.165 |
| ** | 1380814 | SV-1303 |
| 250 | 1380897 | 12.410.050 |
| 116 | 1381883 | 06.559130 |
| 187 | 1381919 | 10.3819.00 |
| 162 | 1384549 | 10.1867.20 |
| 322 | 1390429 | 18.R650.005 |
| ** | 1391384 | A66RK027 |
| 317 | 1393161 | 17.480.010 |
| 314 | 1393187 | 17.460.065 |
| 317 | 1393187 | 17.480.015 |
| 317 | 1393332 | 17.480.020 |
| 131 | 1398840 | 08.4410.50 |
| 132 | 1399776 | 08.8010.70 |
| 138 | 1407139 | 08.8718.10 |
| 317 | 1407430 | 17.480.010 |
| 171 | 1408080 | 10.3340.00 |
| 171 | 1413047 | 10.3034.70 |
| 323 | 1415150 | 18.R650.070 |
| 150 | 1421186 | 09.625.359 |
| 171 | 1421322 | 10.3034.70 |
| 173 | 1421325 | 10.2132.50 |
| 171 | 1423566 | 10.3340.00 |
| 42 | 1424766 | 01.1300.135 |
| 132 | 1430545 | 08.8010.70 |
| 116 | 1431049 | 06.6050.60 |
| 317 | 1434649 | 17.480.020 |
| 67 | 1446037 | 02.2024.00 |
| 138 | 1451839 | 08.8718.10 |
| 162 | 1455253 | 10.1867.20 |
| 317 | 1455730 | 17.480.020 |
| 150 | 1469161 | 09.625.359 |
| 43 | 1470304 | 01.1200.165 |
| 187 | 1476415 | 10.3819.00 |
| 323 | 1477675 | 18.R650.080 |
| 317 | 1479576 | 17.480.025 |
| 187 | 1482997 | 10.8299.70 |
| 150 | 1484715 | 09.R625.359 |
| 171 | 1488083 | 10.3340.00 |
| 317 | 1499770 | 17.480.025 |
| 43 | 1512834 | 01.1200.165 |
| 150 | 1513717 | 09.625.359 |
| 43 | 1514064 | 01.1200.165 |
| 124 | 1520244 | 07.529001 |
| 317 | 1522377 | 17.480.020 |
| 317 | 1545062 | 17.480.010 |
| 248 | 1571059 | 12.410.020 |
| 249 | 1571063 | 12.410.035 |
| 248 | 1571067 | 12.410.010 |
| 249 | 1571068 | 12.410.040 |
| 248 | 1571150 | 12.410.025 |
| 249 | 1571151 | 12.410.045 |
| 249 | 1571153 | 12.410.040 |

| Pág. | SCANIA | AIR-FREN |
|------|----------|-------------|
| 248 | 1575100 | 12.410.020 |
| 317 | 1728165 | 17.480.025 |
| 43 | 1728435 | 01.1200.165 |
| 186 | 1738458 | 10.4410.100 |
| 177 | 1738469 | 10.8400.00 |
| 317 | 1749125 | 17.480.025 |
| 314 | 1749126 | 17.460.075 |
| 43 | 1770607 | 01.1200.165 |
| 162 | 1774598 | 10.1867.70 |
| 43 | 1784109 | 01.1200.165 |
| 43 | 1796663 | 01.1200.165 |
| 173 | 20062660 | 10.9640.00 |
| 269 | 215850 | 13.62654 |
| 170 | 218237 | 10.2182.37 |
| ** | 23090003 | DX-80E |
| 33 | 232032 | 01.1300.45 |
| 49 | 232615 | 01.1200.145 |
| 248 | 259065 | 12.410.015 |
| 249 | 261575 | 12.410.030 |
| 183 | 262082 | 10.3200.60 |
| 269 | 276525 | 13.62620 |
| 269 | 276526 | 13.62621 |
| 269 | 276576 | 13.62621 |
| 269 | 278737 | 13.62624 |
| 269 | 278737 | 13.62660 |
| 269 | 278738 | 13.62625 |
| 269 | 278738 | 13.62661 |
| 269 | 278739 | 13.62622 |
| 137 | 279771 | 08.005001 |
| 137 | 279772 | 08.005002 |
| 137 | 282954 | 08.R8030 |
| 137 | 292178 | 08.413042 |
| 137 | 292179 | 08.413043 |
| 248 | 292761 | 12.410.020 |
| 249 | 292762 | 12.410.035 |
| 155 | 292962 | 09.355.973 |
| 181 | 293382 | 10.R5210 |
| 47 | 300162 | 01.1200.125 |
| 48 | 301525 | 01.1200.140 |
| 171 | 303470 | 10.3034.70 |
| 116 | 307605 | 06.6050.60 |
| 269 | 308677 | 13.62654 |
| 249 | 320592 | 12.410.035 |
| ** | 322368 | SV-1303 |
| 185 | 328855 | 10.5018.10 |
| 124 | 333851 | 07.529001 |
| 149 | 343362 | 09.051.107 |
| 149 | 345362 | 09.051.107 |
| 248 | 347963 | 12.410.010 |
| 80 | 354611 | 03.527003 |
| 155 | 355973 | 09.355.973 |
| 150 | 360717 | 09.360.717 |
| 150 | 360719 | 09.360.717 |
| 269 | 362134 | 13.62631 |
| 269 | 362135 | 13.62630 |
| 47 | 366810 | 01.1300.90 |
| 248 | 369902 | 12.410.010 |
| 150 | 371612 | 09.371.612 |
| 192 | 372420 | 10.579015 |
| 150 | 374116 | 09.371.612 |
| 193 | 380828 | 10.R4510 |
| 249 | 382183 | 12.410.040 |
| 318 | 383695 | 17.490.035 |
| 269 | 383825 | 13.62730 |

| Pág. | SCANIA | AIR-FREN |
|------|--------|---------------|
| 269 | 383826 | 13.62729 |
| 67 | 383890 | 02.2430.00 |
| 269 | 384417 | 13.62620 |
| 269 | 384418 | 13.62621 |
| 269 | 384419 | 13.62622 |
| 314 | 388060 | 17.460.065 |
| 317 | 388060 | 17.480.015 |
| 161 | 390854 | 10.410106 |
| 269 | 394180 | 13.62654 |
| 269 | 394181 | 13.62624 |
| 269 | 394181 | 13.62660 |
| 269 | 394182 | 13.62625 |
| 269 | 394182 | 13.62661 |
| 269 | 394191 | 13.62630 |
| 269 | 394192 | 13.62631 |
| 269 | 394193 | 13.62469 |
| 269 | 394194 | 13.62468 |
| 269 | 394195 | 13.62478 |
| 269 | 394197 | 13.62654 |
| 50 | 394441 | 01.1200.150 |
| 248 | 397957 | 12.410.010 |
| 91 | 405673 | 04.240.726.21 |
| 133 | 405674 | 08.1294.00 |
| ** | 405674 | SV-1294 |
| 133 | 426380 | 08.1295.00 |
| ** | 426380 | SV-1295 |
| 133 | 434535 | 08.1295.00 |
| 96 | 436190 | 04.4234.00 |
| 133 | 438995 | 08.1294.00 |
| 153 | 446414 | 09.446.414 |
| 93 | 469271 | 04.4213.00 |
| ** | 475110 | SV-1323 |
| ** | 475944 | AC155D |
| ** | 492273 | DX-80E |
| 248 | 550044 | 12.R410.015.2 |
| 248 | 550142 | 12.R410.015.1 |
| 248 | 550167 | 12.R410.020.1 |
| 249 | 550206 | 12.R410.045.1 |
| 155 | 550440 | 09.R355.973 |
| 150 | 550453 | 09.R360.717 |
| 143 | 550457 | 09.R051.107 |
| 153 | 550464 | 09.R358.801 |
| 149 | 550465 | 09.R371.612 |
| 149 | 550720 | 09.051.107 |
| 250 | 551355 | 12.R410.055 |
| 250 | 551369 | 12.R410.060 |
| 249 | 551476 | 12.R410.030.1 |
| 249 | 551477 | 12.R410.045.2 |
| 250 | 570952 | 12.410.060 |
| 248 | 571055 | 12.410.015 |
| 248 | 571059 | 12.410.020 |
| 249 | 571063 | 12.410.035 |
| 248 | 571067 | 12.410.010 |
| 249 | 571068 | 12.410.040 |
| 248 | 571150 | 12.410.025 |
| 249 | 571151 | 12.410.045 |
| 249 | 571153 | 12.410.040 |
| 249 | 571154 | 12.410.045 |
| 43 | 571178 | 01.1200.165 |
| 248 | 575100 | 12.410.020 |
| 149 | 575180 | 09.1331.770 |
| 150 | 575182 | 09.360.717 |
| 150 | 575183 | 09.1337.966 |
| 153 | 639088 | 09.R446.414 |

| Pág. | SCANIA | AIR-FREN |
|------|----------|------------|
| 96 | 639131 | 04.R631008 |
| 162 | 639205 | 10.1867.30 |
| 122 | 639398 | 07.R661003 |
| 137 | 677279 | 08.005001 |
| 137 | 677280 | 08.005002 |
| 138 | 90554147 | 08.8718.00 |

SCHMITZ

| Pág. | SCHMITZ | AIR-FREN |
|------|---------|------------|
| 102 | 050024 | 05.9710.00 |
| 107 | 050036 | 05.714000 |
| 107 | 050042 | 05.700000 |
| 173 | 050049 | 10.9640.00 |
| 186 | 050091 | 10.5031.10 |
| 195 | 050227 | 10.432407 |
| 130 | 050419 | 08.8010.40 |
| 130 | 050506 | 08.3032.00 |
| 135 | 050506 | 08.3111.00 |
| 179 | 050601 | 10.543012 |
| 131 | 050671 | 08.4410.60 |
| 192 | 051407 | 10.579015 |
| 192 | 051428 | 10.579014 |
| 108 | 052504 | 05.557006 |
| 131 | 052539 | 08.4410.50 |
| 104 | 053010 | 05.2458.50 |
| 185 | 054505 | 10.5018.10 |
| 186 | 056718 | 10.4410.40 |

SEALCO

| Pág. | SEALCO | AIR-FREN |
|------|--------|-----------|
| 108 | 110200 | 05.545014 |
| 110 | A1000 | 05.545015 |

SEDDON ATKINSON

| Pág. | SEDDON ATKINSON | AIR-FREN |
|------|-----------------|------------|
| 173 | 3303957R91 | 10.9640.00 |
| 147 | 62413S1 | 09.1605.00 |
| ** | 98438178 | VG-3264 |

STEYR

| Pág. | STEYR | AIR-FREN |
|------|----------------|------------|
| 309 | 4S2614A | 17.430.030 |
| 309 | 525426014A00 | 17.430.020 |
| 185 | 527056005000 | 10.5018.10 |
| 129 | 527176005000 | 08.933.492 |
| 121 | 79000360341 | 07.561007 |
| 80 | 792.00.36.0035 | 03.527003 |
| 80 | 792.00.36.0036 | 03.527003 |
| 80 | 79200360280 | 03.527004 |
| 97 | 79200360346 | 04.4225.00 |
| 97 | 79200360348 | 04.4225.00 |
| 97 | 79200360397 | 04.4225.00 |
| 183 | 880K360038 | 10.3200.60 |
| 121 | 89000360426 | 07.561007 |
| 309 | 99000210032 | 17.430.020 |

| Pág. | STEYR | AIR-FREN |
|------|----------------|------------|
| 309 | 99000210050 | 17.430.030 |
| 121 | 99000362030 | 07.561007 |
| 183 | 99000362239 | 10.3200.60 |
| 309 | 9900210032 | 17.430.030 |
| 80 | 991.00.36.0073 | 03.527003 |
| 97 | 99100360024 | 04.4225.00 |
| 173 | 99100360044 | 10.9640.00 |
| 129 | 99100360045 | 08.933.492 |
| 130 | 99100360046 | 08.3032.00 |
| 135 | 99100360046 | 08.3111.00 |
| 185 | 99100360070 | 10.511000 |
| 185 | 99100360082 | 10.5018.10 |
| 80 | 99100360440 | 03.527004 |
| 97 | 99100360444 | 04.4225.00 |
| 94 | 99100360455 | 04.4214.00 |
| 94 | 99100360497 | 04.4214.00 |
| 129 | 99100361496 | 08.933.492 |
| 130 | 99100362124 | 08.3032.00 |
| 135 | 99100362124 | 08.3111.00 |
| 310 | 99114160033 | 17.440.020 |
| 141 | 99114230061 | 09.051.114 |
| 188 | 99114360151 | 10.3200.50 |

TACA

| Pág. | TACA | AIR-FREN |
|------|-------------|--------------|
| ** | 00195914045 | 02.1407.45 |
| ** | 09909106042 | 01.4880 |
| ** | 16100601100 | 1000 |
| ** | 23010001008 | 01.1100.21 |
| ** | 23010001010 | 01.1100.25 |
| ** | 23010001015 | 01.4175 |
| ** | 23010001100 | 01.R1050 |
| ** | 23010001200 | 01.R1100 |
| ** | 23010001208 | 01.4180 |
| ** | 23010002003 | 01.1100.24 |
| ** | 23010002005 | 01.1100.23 |
| ** | 23010002010 | 01.4185 |
| ** | 23010002012 | 01.1105.12 |
| ** | 23010002013 | 4460 |
| ** | 23010002014 | 4465 |
| ** | 23010002020 | 01.1100.22 |
| ** | 23010002021 | 1101 |
| ** | 23010002022 | 1103 |
| ** | 23010002024 | 01.4770 |
| ** | 23010002041 | 4310 |
| ** | 23010002054 | 1051 |
| ** | 23010002055 | 1053 |
| ** | 23010002076 | 01.4190 |
| ** | 23010002077 | 01.4195 |
| ** | 23010002078 | 01.4200 |
| ** | 23010002079 | 01.4205 |
| ** | 23010002091 | 1054 |
| ** | 23010002121 | 1102 |
| ** | 23010002191 | 1052 |
| ** | 23010002194 | 4335 |
| 9 | 2301002 | 01.1100.20 |
| 9 | 2301005 | 01.1100.50 |
| 9 | 2301006 | 01.1100.60 |
| ** | 23010062003 | 01.1100.64 |
| 9 | 2301009 | 01.1100.90 |
| ** | 23010091100 | 01.R7100 |
| ** | 2301040 | 01.230.104.0 |

| Pág. | TACA | AIR-FREN |
|------|-------------|----------------|
| 9 | 2301500 | 01.1500.10 |
| ** | 23015001010 | 01.1500.14 |
| ** | 23015001037 | 01.1500.11 |
| ** | 23015001108 | 01.1500.13 |
| ** | 23015002007 | 01.1500.12 |
| ** | 23015002042 | 5520-1 |
| ** | 2302000 | 01.2320.00 |
| ** | 23020001010 | 01.2320.41 |
| ** | 23020002042 | 5520-2 |
| ** | 23020031037 | 01.2320.37 |
| 9 | 2302004 | 01.2320.40 |
| ** | 23020041003 | 01.2320.43 |
| ** | 23020041008 | 01.2320.48 |
| ** | 23020042007 | 01.2320.07 |
| 10 | 2302008 | 01.2320.80 |
| 10 | 2302009 | 01.2320.90 |
| 10 | 2303000 | 01.1150.00 |
| ** | 23030001003 | 01.1150.61 |
| ** | 23030001010 | 01.1150.67 |
| ** | 23030001020 | 01.4215 |
| ** | 23030001037 | 01.1150.64 |
| ** | 23030001100 | 01.R1150 |
| ** | 23030001108 | 01.1150.68 |
| ** | 23030001109 | 01.4220 |
| ** | 23030001510 | 01.4225 |
| ** | 23030002007 | 01.1150.63 |
| ** | 23030002011 | 01.4230 |
| ** | 23030002014 | 3010-14 |
| ** | 23030002043 | 01.4615 |
| ** | 23030002077 | 01.4235 |
| ** | 23030002078 | 01.4240 |
| ** | 23030002081 | 01.4245 |
| ** | 23030002082 | 01.2807 |
| ** | 23030002091 | 1155 |
| ** | 23030011100 | 01.R1150E |
| 10 | 2303002 | 01.1150.20 |
| ** | 2303003 | 01.1150.30 |
| ** | 23030051008 | 01.1150.62 |
| 11 | 2303006 | 01.1150.60 |
| ** | 23030081037 | 01.3081.37 |
| ** | 23030082004 | 230.300.82.004 |
| ** | 23030082082 | 01.4260 |
| ** | 23030082181 | 01.4265 |
| 11 | 2303009 | 01.1150.90 |
| ** | 23030091100 | 01.R5950 |
| 11 | 2303016 | 01.230.301.6 |
| 11 | 2303017 | 01.230.301.7 |
| 11 | 2303018 | 01.230.301.8 |
| 11 | 2303030 | 01.230.303.0 |
| ** | 23030301003 | 01.2303.03 |
| ** | 23030301037 | 01.2303.37 |
| 12 | 2303050 | 01.3005.00 |
| ** | 23030501008 | 01.3005.11 |
| ** | 23030501010 | 01.4405 |
| ** | 23030501100 | 01.R6100 |
| ** | 23030502007 | 01.3011.07 |
| ** | 23030502076 | 01.4410 |
| ** | 23030512010 | 01.5770 |
| 12 | 2303052 | 01.3005.20 |
| ** | 23030522010 | 01.5771 |
| ** | 23037001008 | 01.3701.08 |
| ** | 23037001010 | 01.3701.14 |
| ** | 23037002007 | 01.3701.11 |
| ** | 23037002011 | 01.5525 |

| Pág. | TACA | AIR-FREN |
|------|-------------|--------------|
| ** | 23037002021 | 5000175 |
| ** | 23037002076 | 01.5360 |
| 12 | 2303701 | 01.3701.10 |
| ** | 23037011037 | 01.3701.12 |
| 12 | 2303702 | 01.3701.20 |
| 12 | 2303703 | 01.3701.30 |
| 12 | 2303704 | 01.3701.40 |
| ** | 23037041037 | 01.3701.15 |
| 12 | 2303705 | 01.3701.50 |
| ** | 23037051037 | 01.3701.41 |
| 12 | 2303706 | 01.3701.60 |
| 12 | 2303709 | 01.3701.90 |
| ** | 23037101010 | 01.527.352 |
| 14 | 23037101020 | 01.523.060 |
| ** | 23037101037 | 01.568.841 |
| ** | 23037102004 | 01.527.349 |
| ** | 23037102007 | 01.643.008 |
| ** | 23037112007 | 01.199.106 |
| ** | 23037112037 | 01.562.261 |
| ** | 23050001020 | 01.5965 |
| ** | 23050001200 | 11.R6400 |
| ** | 23110101008 | 01.1024.41 |
| ** | 23110101100 | 1200 |
| ** | 23110102005 | 01.1024.43 |
| ** | 23110102024 | 01.1024.44 |
| ** | 23110102077 | 01.4275 |
| ** | 23110102078 | 01.4280 |
| ** | 23110191100 | 01.R7150 |
| 15 | 2311024 | 01.1024.40 |
| ** | 23110601005 | 01.1106.10 |
| 15 | 2311065 | 01.1024.50 |
| 15 | 2311067 | 01.1024.70 |
| 15 | 2311068 | 01.1024.80 |
| 15 | 2311069 | 01.1024.90 |
| 76 | 23501602083 | 02.1302.1 |
| ** | 2350240 | 235.024.0 |
| ** | 23502401100 | 1250 |
| 198 | 2350300 | 10.235.030.0 |
| ** | 23508001100 | 02.R1300 |
| 76 | 23510001083 | 02.1302 |
| 75 | 23510001100 | 02.R1350 |
| ** | 23510002082 | 02.1351 |
| 75 | 2351002 | 02.1350.20 |
| 75 | 2351250 | 02.1400.10 |
| ** | 23512501008 | 02.1400.11 |
| 75 | 23512501100 | 02.R1400 |
| ** | 23512502076 | 02.1402 |
| ** | 23512512082 | 02.1401 |
| 75 | 23512601100 | 02.R1500 |
| 75 | 2351263 | 02.1500.30 |
| 75 | 2351270 | 02.1400.10 |
| ** | 23512701100 | 02.R1550 |
| ** | 23704501100 | 11.R5900 |
| ** | 23704502081 | 4320 |
| ** | 23704502082 | 4325 |
| ** | 2370753 | 237.075.3 |
| 71 | 23802001081 | 02.1601L |
| 71 | 23802002084 | 02.1601 |
| ** | 23802002091 | 4685 |
| 72 | 23802041005 | 02.2020.05 |
| ** | 23802052091 | 1600-91 |
| 72 | 23802061100 | 02.R1600 |
| 70 | 2380211 | 02.1600.20 |
| 70 | 2380215 | 02.1600.50 |

| Pág. | TACA | AIR-FREN |
|------|-------------|-----------------|
| 70 | 23802151100 | 02.R5050 |
| 73 | 23802401037 | 02.2424.06 |
| 71 | 23802402081 | 02.1802 |
| 72 | 23802441100 | 02.R5700 |
| 71 | 23803002081 | 02.1651 |
| 72 | 23803051100 | 02.R9000N |
| ** | 23803052004 | 8032-52 |
| ** | 23803082005 | 1678-05 |
| 72 | 23803101100 | 02.R1650 |
| ** | 23803101200 | 02.R1700 |
| 72 | 23803101300 | 02.R1650E |
| 70 | 23803801100 | 02.R9000 |
| 70 | 23803801200 | 02.R9000E |
| 75 | 2381252 | 02.1750.20 |
| 75 | 23812521100 | 02.R1750 |
| ** | 23812522006 | 4285 |
| ** | 23812522181 | 4290 |
| 67 | 2390240 | 02.2424.00 |
| 72 | 23902401100 | 02.R1800 |
| 72 | 23903171100 | 02.R5150 |
| ** | 24000102081 | 3960 |
| ** | 2400012 | 10.2400.12 |
| 198 | 2400013 | 10.2400.13 |
| ** | 2400014 | 10.2400.14 |
| ** | 24001502081 | 1905 |
| 79 | 2400151 | 03.1900.10 |
| 79 | 24001511100 | 03.R1900 |
| ** | 24001512081 | 1906 |
| 79 | 2400153 | 03.1900.30 |
| ** | 24011002081 | 14.1953 |
| 198 | 2401101 | 10.1950.10 |
| 198 | 24011071100 | 10.R1950 |
| ** | 24021401100 | 11.R2000 |
| ** | 2402460 | 2050-00 |
| ** | 24024601100 | 11.R2050 |
| ** | 24024661100 | 2100 |
| 198 | 2405550 | 10.2405.55 |
| 198 | 24055501100 | 10.R2150 |
| ** | 24060002081 | 4500 |
| ** | 24061701018 | 10.4295 |
| ** | 24061702086 | 3958 |
| ** | 24061702090 | 2208 |
| ** | 24061761100 | 11.R2200 |
| 196 | 2406177 | 10.2250.70 |
| 196 | 24061771100 | 10.R2250 |
| 80 | 2406540 | 03.240.654.0 |
| 80 | 24065401100 | 03.R2300 |
| 80 | 2406542 | 03.240.654.0 |
| 80 | 2406547 | 03.240.654.0 |
| 89 | 2407240 | 04.240.724.0 |
| 89 | 24072401100 | 04.R2400 |
| ** | 24072402082 | 1903 |
| 89 | 2407242 | 04.240.724.0 |
| ** | 2407244 | 04.240.724.4 |
| ** | 2407251 | 04.240.725.1 |
| 90 | 24072601020 | 04.240.726.01.0 |
| 90 | 24072641020 | 04.240.726.41.0 |
| 196 | 2407570 | 10.2550.00 |
| 196 | 24075701100 | 10.R2550 |
| 196 | 2407573 | 10.2600.30 |
| 196 | 24075731100 | 10.R2600 |
| 196 | 2416170 | 10.2650.10 |
| 196 | 24161701100 | 10.R2650 |
| ** | 2416171 | 10.2700.10 |

| Pág. | TACA | AIR-FREN |
|------|-------------|--------------|
| ** | 24161711100 | 10.R2700 |
| 104 | 2440082 | 05.557007 |
| 211 | 24400821100 | 11.R2750 |
| 211 | 24400921100 | 11.R2750 |
| 111 | 2440120 | 05.2440.12 |
| 111 | 24401201100 | 05.R7000 |
| 111 | 2440140 | 05.2440.14 |
| 183 | 2440152 | 10.2440.15 |
| ** | 24401801100 | 11.R2800 |
| 181 | 2440192 | 10.2440.19 |
| ** | 2440201 | 10.244.020.1 |
| ** | 2440202 | 10.244.020.2 |
| ** | 24402201100 | 11.R2850 |
| 182 | 2440223 | 10.2950.60 |
| 101 | 2440230 | 05.545003 |
| ** | 24402301100 | 11.R2900 |
| 182 | 2443140 | 10.2950.00 |
| 212 | 24431401100 | 11.R2950 |
| 182 | 2443141 | 10.2950.10 |
| 182 | 2443142 | 10.2950.20 |
| 182 | 2443143 | 10.2950.30 |
| 182 | 2443144 | 10.2950.40 |
| 182 | 2443145 | 10.2950.50 |
| 182 | 2443146 | 10.2950.60 |
| 182 | 2443147 | 10.2950.70 |
| 182 | 2443148 | 10.2950.80 |
| 182 | 2443149 | 10.2950.90 |
| ** | 2443150 | 10.244.315.0 |
| ** | 2443151 | 10.244.315.1 |
| ** | 2443152 | 10.244.315.2 |
| ** | 2445490 | 3150-10 |
| 212 | 24454901100 | 11.R3150 |
| ** | 24461811100 | 11.R3200 |
| 183 | 2446183 | 10.3200.30 |
| 108 | 2446400 | 05.557005 |
| 211 | 24464001100 | 11.R3250 |
| 198 | 2446760 | 10.3300.10 |
| 198 | 24467601100 | 10.R3300 |
| ** | 2446765 | 10.3300.50 |
| 178 | 2446770 | 10.543002 |
| ** | 24469902093 | 4350 |
| ** | 24481401006 | 14.4052 |
| ** | 24481411100 | 11.R3400 |
| ** | 24481412085 | 1255 |
| 182 | 2448520 | 10.3450.10 |
| 182 | 24485201100 | 10.R3450 |
| 182 | 2448522 | 10.3450.10 |
| 125 | 24500111100 | 07.R3500 |
| 125 | 2450013 | 07.3500.30 |
| 125 | 2450016 | 07.3500.60 |
| 124 | 24500201100 | 07.R3600 |
| ** | 24500301005 | 4300 |
| ** | 24500301071 | 4380 |
| 125 | 24500301100 | 07.R3550 |
| 125 | 2450031 | 07.3550.20 |
| 125 | 2450032 | 07.3550.20 |
| 125 | 2450035 | 07.3550.20 |
| 212 | 24501301100 | 11.R3650 |
| ** | 2450135 | 3650-50 |
| 103 | 2452320 | 05.605733 |
| 211 | 24523201100 | 11.R3700 |
| 181 | 2452321 | 10.5210.60 |
| 211 | 24523301100 | 11.R3700E |
| ** | 2457060 | 05.3750.00 |

| Pág. | TACA | AIR-FREN |
|------|-------------|-------------|
| 211 | 24570601100 | 11.R3750 |
| 196 | 2458480 | 10.2458.48 |
| 196 | 24584801100 | 10.R7250 |
| 183 | 2462540 | 10.8321.00 |
| ** | 2463150 | 10.4375.00 |
| 178 | 2466520 | 10.930.930 |
| 178 | 2466521 | 10.930.930 |
| 61 | 2467000 | 01.7000.10 |
| 183 | 2467151 | 10.4375.10 |
| 182 | 2471330 | 10.4395.10 |
| 191 | 2472140 | 10.579006 |
| 191 | 2472141 | 10.579005 |
| 191 | 2472150 | 10.579004 |
| 191 | 2472151 | 10.579003 |
| 191 | 2472152 | 10.579002 |
| 191 | 2472153 | 10.579001 |
| 191 | 2473150 | 10.3500.22A |
| 191 | 2473151 | 10.3500.22R |
| 191 | 2473160 | 10.3500.16A |
| 191 | 2473161 | 10.3500.16R |
| 285 | 24764802081 | 14.4315 |
| 101 | 2490013 | 05.575537 |
| 62 | 2590050 | 01.2590.05 |
| 62 | 2590200 | 01.2460.20 |
| 62 | 2590400 | 01.2760.40 |
| 62 | 2590600 | 01.2760.60 |
| ** | 2592060 | 259.206.0 |
| ** | 26017511100 | 11.R4750 |
| ** | 26100102029 | 2019 |
| ** | 26700102082 | 3858 |
| 197 | 2670100 | 10.7010.00 |
| 197 | 2670101 | 10.7010.10 |
| 197 | 26701011100 | 10.R3950 |
| 197 | 2670104 | 10.7010.40 |
| 197 | 26701041100 | 10.R4000 |
| 197 | 2670106 | 10.7010.60 |
| ** | 26701061007 | 7010-61 |
| 197 | 26701061100 | 10.R4050 |
| 197 | 2670107 | 10.7010.70 |
| ** | 2670109 | 10.7010.90 |
| 197 | 2670123 | 10.2670.12 |
| 197 | 2670124 | 10.2670.12 |
| 197 | 26701241100 | 10.R5750 |
| 197 | 2670126 | 10.2670.16 |
| 197 | 26701261100 | 10.R5750 |
| ** | 29000102032 | 5000153 |
| ** | 29001002049 | 5000103 |
| ** | 29001002052 | 4101 |
| ** | 29002002005 | 4102 |
| 289 | 29004001005 | 14.4710 |
| ** | 29005002005 | 5000154 |
| 289 | 29006002006 | 14.5000178 |
| ** | 29006002007 | 5000159 |
| ** | 29008002175 | 5000175 |
| ** | 29010001100 | 11.R4100 |
| ** | 29010022005 | 5000244 |
| ** | 29010022009 | 5000203 |
| ** | 29010022022 | 5002022 |
| ** | 29011002014 | 5000240 |
| ** | 29013002011 | 5000200 |
| ** | 29020002006 | 5000250 |
| ** | 29020002036 | 5002502 |
| ** | 29020002044 | 5000271 |
| ** | 29095002185 | 5000177 |

| Pág. | TACA | AIR-FREN |
|------|-------------|------------|
| ** | 29095012505 | 5002519 |
| ** | 29810002005 | 14.2021 |
| ** | 34003822084 | 4169 |
| ** | 37522102202 | 3959 |
| 212 | 54007011100 | 11.R4150 |
| ** | 5770 | 1481290015 |
| 212 | 950312007 | 11.R3650 |

TECHNOMATIC

| Pág. | TECHNOMATIC | AIR-FREN |
|------|-------------|------------|
| 175 | 1558 | 10.1883.80 |
| 175 | 1601 | 10.1883.80 |
| 175 | 447 | 10.1883.85 |
| 175 | 477 | 10.1883.75 |

TEREX-DEMAG

| Pág. | TEREX-DEMAG | AIR-FREN |
|------|-------------|-------------|
| 185 | 00132412 | 10.5018.00 |
| 145 | 00619208 | 09.051.111 |
| 185 | 08748500 | 10.511000 |
| 173 | 20732340 | 10.4750.00 |
| 191 | 26435840 | 10.579013 |
| 96 | 29571240 | 04.4224.00 |
| 94 | 40150612 | 04.R4214 |
| 192 | 41616940 | 10.579014 |
| 105 | 44054712 | 05.R009000 |
| 121 | 46131340 | 07.561007 |
| 185 | 46189840 | 10.5018.10 |
| 95 | 49091940 | 04.4219.00 |
| 94 | 55124940 | 04.4214.00 |
| 195 | 62129940 | 10.432407.1 |
| 195 | 63442540 | 10.432407 |
| 192 | 63525540 | 10.579015 |
| 173 | 63562240 | 10.4750.00 |
| 183 | 96901300 | 10.R8321 |
| 181 | 96908000 | 10.R5210 |
| 149 | 96910300 | 09.051.102 |
| ** | 96914500 | 10.R3200E |
| 96 | 96932500 | 04.R631008 |
| 122 | 96934400 | 07.R661003 |
| 173 | 97936373 | 10.4750.00 |

TRAILOR

| Pág. | TRAILOR | AIR-FREN |
|------|----------|------------|
| 306 | 6502085P | 16.7290.00 |

URO

| Pág. | URO | AIR-FREN |
|------|--------|--------------|
| 9 | 210042 | 01.1500.10 |
| 115 | 210044 | 06.539110 |
| 183 | 210059 | 10.8321.00 |
| 65 | 210062 | 02.239.016.1 |
| 89 | 210064 | 04.240.726.6 |
| 178 | 210065 | 10.543002 |
| 70 | 210066 | 02.1600.20 |
| 105 | 210085 | 05.557004 |

| Pág. | URO | AIR-FREN |
|------|--------|---------------|
| 183 | 210089 | 10.2440.15 |
| 184 | 210200 | 10.8210.00 |
| 70 | 210314 | 02.1800.00 |
| ** | 210315 | 461.307.458.0 |
| 80 | 210502 | 03.527001 |

VALEO

| Pág. | VALEO | AIR-FREN |
|------|--------|------------|
| 317 | 079806 | 17.480.010 |
| 316 | 262341 | 17.470.030 |
| 317 | 830010 | 17.480.025 |

VAN HOOL

| Pág. | VAN HOOL | AIR-FREN |
|------|-----------|------------|
| 309 | 10628942 | 17.430.035 |
| 309 | 10945803 | 17.430.035 |
| 309 | 10996015 | 17.430.035 |
| 141 | 2477724 | 09.051.114 |
| 309 | 623100700 | 17.430.010 |
| 309 | 632100150 | 17.430.015 |
| 309 | 632100260 | 17.430.020 |
| 313 | 632100390 | 17.460.040 |
| 312 | 632100450 | 17.460.030 |
| 311 | 632100480 | 17.450.030 |
| 309 | 632100560 | 17.430.030 |
| 309 | 632101620 | 17.430.035 |
| 311 | 632101630 | 17.450.030 |
| 149 | 637206630 | 09.051.102 |
| 67 | 637207790 | 02.2424.00 |
| 67 | 637207810 | 02.3630.00 |
| 67 | 637207840 | 02.2424.00 |
| 141 | 637208220 | 09.051.114 |
| 144 | 637208220 | 09.051.126 |
| 141 | 637208440 | 09.051.114 |
| 144 | 637208440 | 09.051.126 |
| 146 | 637208670 | 09.051.131 |
| 181 | 637406440 | 10.R5210 |
| 173 | 637409860 | 10.4750.00 |
| 172 | 660526519 | 10.4720.00 |
| 309 | 700113365 | 17.430.015 |

VOLVO

| Pág. | VOLVO | AIR-FREN |
|------|----------|------------|
| 170 | 1068951 | 10.6800.00 |
| 185 | 1079666 | 10.5018.00 |
| 33 | 1080437 | 01.1200.60 |
| 164 | 1082030 | 10.431100 |
| 170 | 1092123 | 10.9200.00 |
| 104 | 11018647 | 05.557007 |
| 271 | 1134297 | 13.60635 |
| 178 | 1135002 | 10.543002 |
| 84 | 1137213 | 03.527017 |
| 84 | 1193173 | 03.527017 |
| 271 | 1195461 | 13.62782 |
| 271 | 1195462 | 13.62783 |
| 185 | 1195752 | 10.5018.10 |
| 271 | 1196321 | 13.62678 |
| 271 | 1196322 | 13.62726 |



| Pág. | VOLVO | AIR-FREN | Pág. | VOLVO | AIR-FREN | Pág. | VOLVO | AIR-FREN | Pág. | VOLVO | AIR-FREN |
|------|---------|-------------|-----------------|------------|-------------|---------|------------|-------------|---------|------------|---------------|
| 271 | 1197965 | 13.62232 | 106 | 1628951 | 05.533001 | 80 | 270890 | 03.R627001 | 253 | 425308 | 12.420.045 |
| 271 | 1197966 | 13.62233 | ** | 1628955 | 05.711.000 | 153 | 2711067 | 09.R620.462 | 252 | 467906 | 12.420.010 |
| 38 | 1376272 | 01.391.650 | 150 | 1655435 | 09.655.435 | 179 | 272504 | 10.543012 | 252 | 467915 | 12.420.025 |
| 44 | 1376274 | 01.1300.180 | 151 | 1655639 | 09.655.639 | 182 | 272509 | 10.2950.40 | ** | 468387 | 11-68387 |
| 314 | 1393187 | 17.460.065 | 318 | 1655732 | 17.490.015 | 101 | 272517 | 05.R645002 | 91 | 4822431 | 04.240.726.21 |
| 82 | 1500494 | 03.105508 | 318 | 1655732 | 17.490.025 | 183 | 272579 | 10.R8321 | 35 | 5003460 | 01.1200.70 |
| 124 | 1503492 | 07.529001 | 318 | 1655825 | 17.490.015 | 115 | 272701 | 06.R639008 | 101 | 571174 | 05.545004 |
| 290 | 1505035 | 14.7031.00 | 318 | 1655829 | 17.490.035 | 105 | 272750 | 05.R657000 | 82 | 6231643 | 03.105510 |
| 82 | 1508614 | 03.105508 | 318 | 1655843 | 17.490.020 | 90 | 272794 | 04.R631009 | ** | 628491 | MB-4849 |
| 33 | 1518372 | 01.391.450 | 318 | 1655843 | 17.490.030 | 107 | 272799 | 05.R700403 | 82 | 6642318 | 03.105508 |
| 33 | 1518374 | 01.1300.45 | 318 | 1667258 | 17.490.015 | ** | 272799 | 11.R2959 | 124 | 6645225 | 07.R629002 |
| 71 | 1518481 | 02.1636L | 150 | 1668501 | 09.655.435 | 58 | 272813 | 01.R391.117 | 93 | 6702610 | 04.4213.00 |
| 150 | 1521371 | 09.655.435 | 318 | 1668921 | 17.490.020 | 58 | 272878 | 01.R391.118 | 130 | 6773736 | 08.3032.00 |
| 151 | 1526523 | 09.655.639 | 318 | 1668923 | 17.490.015 | 153 | 273660 | 09.R620.462 | 135 | 6773736 | 08.3111.00 |
| 318 | 1527693 | 17.490.010 | 170 | 1669324 | 10.6900.00 | 208 | 273851 | 11.R2956 | ** | 6773737 | SV-1280 |
| 252 | 1545246 | 12.420.020 | 153 | 1669488 | 09.620.462 | 208 | 273987 | 11.R2957 | 173 | 6774463 | 10.0030.02 |
| 253 | 1545248 | 12.420.030 | 318 | 1669832 | 17.490.020 | 254 | 275613 | 12.R420.055 | 93 | 6792610 | 04.4213.00 |
| 252 | 1545261 | 12.420.015 | 318 | 1669833 | 17.490.015 | 252 | 275615 | 12.R420.015 | 309 | 685611 | 17.430.010 |
| 252 | 1545427 | 12.420.025 | 150 | 1671953 | 09.655.435 | 252 | 275618 | 12.R420.010 | 91 | 6876972 | 04.240.726.21 |
| 33 | 1570994 | 01.1200.60 | 318 | 1672944 | 17.490.020 | 252 | 275986 | 12.R420.010 | 91 | 6876972 | 04.240.726.23 |
| 115 | 1573255 | 06.539110 | 318 | 1672944 | 17.490.030 | 93 | 276081 | 04.R4213 | 93 | 6876972 | 04.4100.00 |
| 129 | 1576736 | 08.933.492 | 318 | 1672946 | 17.490.015 | 129 | 276101 | 08.R8015 | 181 | 6889576 | 10.R5210 |
| 153 | 1581209 | 09.620.462 | 151 | 1673067 | 09.655.639 | 164 | 276173 | 10.432200 | 80 | 6996123 | 03.527003 |
| 183 | 1581425 | 10.4375.10 | 314 | 1673220 | 17.460.065 | 252 | 276800 | 12.R420.010 | 133 | 8030222 | 08.1295.00 |
| 271 | 1581485 | 13.60921 | 253 | 1675945 | 12.420.040 | 252 | 276802 | 12.R420.015 | 129 | 8030222 | 08.933.492 |
| 271 | 1581486 | 13.60922 | ** | 1695129 | 11.R2928 | 253 | 276814 | 12.R420.040 | ** | 8030222 | SV-1295 |
| 105 | 1585346 | 05.557004 | 33 | 1695153 | 01.1300.45 | 254 | 276854 | 12.R420.055 | 318 | 8112159 | 17.490.015 |
| 271 | 1586190 | 13.60921 | 84 | 1695943 | 03.527018 | 277 | 278800 | 13.66046 | 318 | 8112167 | 17.490.010 |
| 271 | 1586191 | 13.60922 | ** | 1696129 | 11.R2928 | 195 | 3028745 | 10.432407 | 318 | 8112168 | 17.490.010 |
| 271 | 1586192 | 13.60923 | 82 | 1696150 | 03.105508 | 161 | 3090268 | 10.1867.10 | 164 | 8112337 | 10.431100 |
| 271 | 1586193 | 13.60924 | 71 | 1696583 | 02.1616 | 161 | 3090288 | 10.1867.10 | ** | 8113023 | LP-4967 |
| 271 | 1586194 | 13.60920 | 106 | 1697318 | 05.R633001 | 161 | 3090288 | 10.1867.10 | ** | 8113264 | LP-4974 |
| 133 | 1587153 | 08.1294.00 | 36 | 1697770 | 01.391.550 | 34 | 3090378 | 01.1300.160 | 254 | 8113274 | 12.420.055 |
| 90 | 1588103 | 04.565590 | 36 | 1697770+ | | 34 | 3090380 | 01.391.600 | 132 | 8141934 | 08.8010.60 |
| 80 | 1589620 | 03.527001 | 1697290 | 01.391.550 | 33 | 3090471 | 01.R110061 | 172 | 8143448 | 10.3380.00 | |
| 182 | 1590128 | 10.2950.10 | 36 | 1697771 | 01.1300.55 | 33 | 3090472 | 01.1300.45 | 254 | 8149882 | 12.420.065 |
| 182 | 1590128 | 10.2950.90 | 37 | 1698156 | 01.1300.60 | 33 | 3090473 | 01.391.500 | 254 | 8149941 | 12.420.060 |
| 33 | 1590264 | 01.1200.60 | 252 | 1698617 | 12.420.020 | 94 | 3090943 | 04.R4214 | 254 | 8149980 | 12.420.070 |
| 173 | 1591032 | 10.9640.00 | 35 | 1698680 | 01.1300.50 | 181 | 3091219 | 10.R5310 | 34 | 8150407 | 01.1200.65 |
| 271 | 1592871 | 13.62672 | 252 | 1699785 | 12.420.010 | 170 | 3091916 | 10.9200.00 | ** | 8150407 | LP-4825 |
| 271 | 1592872 | 13.62673 | 253 | 1699788 | 12.420.030 | 170 | 3092123 | 10.9200.00 | 192 | 8151957 | 10.579015 |
| 271 | 1592876 | 13.62676 | 252 | 1699789 | 12.420.025 | 153 | 3094523 | 09.R628.218 | 254 | 8170305 | 12.420.055 |
| 81 | 1598125 | 03.527007 | 38 | 1699820 | 01.1300.165 | 81 | 3094552 | 03.R527007 | 151 | 8171700 | 09.628.494 |
| 94 | 1598586 | 04.4217.00 | 131 | 20356553 | 08.4410.70 | 164 | 3094804 | 10.R431100 | 151 | 8171720 | 09.628.492 |
| 36 | 1599999 | 01.1200.75 | 254 | 20431135 | 12.420.080 | 151 | 3095041 | 09.R655.639 | 151 | 8171721 | 09.628.493 |
| ** | 1599999 | LP-4812 | 183 | 20516178 + | | 170 | 3095080 | 10.6900.00 | 151 | 8171722 | 09.628.494 |
| 129 | 1607728 | 08.8010.30 | 3 Racor 5000164 | 10.3200.30 | 38 | 3097146 | 01.391.650 | 170 | 8172628 | 10.6700.00 | |
| 106 | 1607836 | 05.533001 | 162 | 20557234 | 10.1867.70 | 101 | 3173150 | 05.545004 | 254 | 8192050 | 12.420.075 |
| 105 | 1607887 | 05.009000 | 318 | 20569157 | 17.490.020 | 195 | 3181131 | 10.432407 | 38 | 85000064 | 01.1200.90 |
| 124 | 1607889 | 07.7070.20 | 318 | 20571928 | 17.490.015 | 182 | 3181897 | 10.2950.55 | ** | 85000064 | LP-4974 |
| 33 | 1612335 | 01.1200.60 | 314 | 20571945 | 17.460.065 | 318 | 3192222 | 17.490.020 | 254 | 85000076 | 12.420.055 |
| 80 | 1613328 | 03.527001 | 318 | 20571946 | 17.490.035 | 318 | 3192223 | 17.490.015 | 254 | 85000452 | 12.420.055 |
| ** | 1613632 | LP-4813 | 41 | 20701801 | 01.1200.180 | 71 | 338458 | 02.1612 | 151 | 85102142 | 09.R628.492 |
| 153 | 1614351 | 09.620.462 | 41 | 20701803 | 01.1300.120 | 101 | 348909 | 05.545003 | 188 | 9515216 | 10.3200.50 |
| 71 | 1614797 | 02.1601 | 254 | 20713787 | 12.420.080 | 318 | 352221 | 17.490.010 | 91 | 9515443 | 04.240.726.21 |
| 71 | 1614798 | 02.1802 | 137 | 244302 | 08.413042 | 107 | 362521 | 05.6120.50 | 271 | 9518357 | 13.69072 |
| 71 | 1614799 | 02.1651 | 137 | 244303 | 08.413043 | 137 | 367838 | 08.005006 | ** | 9518580 | SV-1399 |
| 153 | 1620462 | 09.620.462 | 105 | 244818 | 05.R657002 | 137 | 367839 | 08.005007 | 164 | 9519475 | 10.410113 |
| 97 | 1622356 | 04.4226.00 | 318 | 267156 | 17.490.010 | 172 | 3944186 | 10.3380.00 | ** | 9521675 | LP-4967 |
| 35 | 1626060 | 01.1200.70 | 177 | 267859 | 10.559006 | 124 | 3944251 | 07.7070.20 | 192 | 9985016 | 10.579015 |
| 153 | 1628218 | 09.628.218 | 177 | 268759 | 10.559006 | 124 | 3944252 | 07.529001 | 82 | Ml6231643 | 03.105510 |
| 81 | 1628491 | 03.4849.00 | 107 | 270617 | 05.R711000 | 131 | 400051 | 08.4410.60 | | | |
| 38 | 1628593 | 01.1200.90 | 253 | 270791 | 12.R420.035 | 253 | 422311 | 12.420.050 | | | |
| ** | 1628593 | LP-4974 | 36 | 270879 | 01.R391.119 | 253 | 422791 | 12.420.035 | | | |

CRUCE DE REFERENCIAS: REFERENCIAS ORIGINALES / AIR FREN

CROSS REFERENCE LIST: ORIGINAL REFERENCES / AIR FREN

| WABCO | | Pág. WABCO | AIR-FREN | Pág. WABCO | AIR-FREN | Pág. WABCO | AIR-FREN | | | | |
|------------|------------|-----------------|----------|-----------------|----------------|------------|---------------------------------------|--------------|-------------|------------|----------------|
| Pág. WABCO | AIR-FREN | | | | | | | | | | |
| 73 | 0203561409 | 02.03561409 | | 178 | 4043775 | 10.R430527 | ** | 4170136 | 02.1600.20E | | |
| 125 | 1335279208 | 07.1335.00 | 288 | 4021924 | 14.2545.00 | 141 | 4043793 | 09.R051.114 | 65 | 4170136 | 02.239.020.1C |
| 105 | 1450726 | 05.009300 | 115 | 4022059 | 06.R639008 | 145 | 4043805 | 09.R051.111 | 65 | 4170604 | 02.239.020.1EE |
| 72 | 4003191 | 02.2020.05 | 115 | 4022068 | 06.R639008 | 204 | 4044024 | 11.R2921 | 65 | 4170631 | 02.239.020.1EE |
| 74 | 4003605 | 02.1805 | ** | 4022992 | 238.024.02.084 | 61 | 4044426 | 01.R178.054 | 65 | 4172172 | 02.239.020.1 |
| 74 | 4003614 | 02.9000.91 | 74 | 4023054 | 02.1701.1 | 161 | 4045524 | 10.R611004 | 65 | 4172211 | 02.239.020.1 |
| ** | 4003623 | 238.024.51.012 | 72 | 4023193 | 02.2424.05 | ** | 4045841 | 01.R196.214 | 65 | 4180025 | 02.239.016.1 |
| 71 | 4004534 | 02.1601 | ** | 4023287 | 02.1809.05 | ** | 4045850 | 01.R196.215 | 65 | 4180137 | 02.239.016.1 |
| 71 | 4004543 | 02.1802 | 74 | 4023924 | 02.1805 | 61 | 4045926 | 01.R196.052 | 90 | 4200127 | 04.240.726.12 |
| 71 | 4004552 | 02.1651 | ** | 4024237 | 01.391.098 | 33 | 4045962 | 01.R110061 | 89 | 4200417 | 04.240.726.0 |
| 70 | 4004927 | 02.9000.30 | 54 | 4024264 | 01.391.002 | 61 | 4045962 | 01.R192.164 | 89 | 4200426 | 04.240.726.7 |
| 186 | 4006004640 | 10.5031.00 | ** | 4024312 Antigua | 01.391.099 | 138 | 4047609 | 08.R005000 | 89 | 4200462 | 04.240.726.19 |
| 185 | 4006004650 | 10.5040.10 | 73 | 4025568 | 02.3030.06 | ** | 4047663 | 220.839 | 89 | 4200613 | 04.240.726.5 |
| 71 | 4006123 | 02.1636L | 204 | 4026116 | 11.R2925 | 155 | 4049690 | 09.R1883.60 | 89 | 4200640 | 04.240.726.8 |
| 70 | 4007593 | 02.1800.30 | ** | 4026255 | 11.R195.211 | ** | 4050070 | 01.391.103.3 | 89 | 4200707 | 04.240.726.17 |
| ** | 4007874 | 238.024.51.012 | 211 | 4026255 | 11.R65.00 | ** | 4050098 Moderna | 01.391.099 | 89 | 4200743 | 04.240.726.3 |
| 72 | 4008927 | 02.3030.05 | 106 | 4026367 | 05.R633001 | 27 | 4110128100 | 01.1200.135 | 90 | 4200800 | 04.240.726.4 |
| 72 | 4008963 | 02.2424.05 | 105 | 4026497 | 05.R657002 | ** | 4110335032 | 01.391.400.1 | 90 | 4200846 | 04.240.726.14 |
| ** | 4011361 | 11.R0136.1 | 182 | 4026983 | 10.R3800E | 16 | 4110338062 | 01.1300.10 | 89 | 4200864 | 04.240.726.1 |
| 143 | 4011391 | 09.R051.107 | 14 | 4027269 | 01.523.060 | 17 | 4110340510 | 01.1200.15 | 89 | 4200949 | 04.240.726.6 |
| 74 | 4011549 | 02.1701.1 | ** | 4027429 | 01.648.001 | 17 | 4110345002 | 01.391.150 | 90 | 4200967 | 04.240.726.15 |
| 182 | 4012955 | 10.R1965 | ** | 4027951 | 01.568.841 | 17 | 4110345010 | 01.1200.15 | 89 | 4201001 | 04.240.726.9 |
| 183 | 4012964 | 10.R8321 | 211 | 4028358 | 11.R100.00 | ** | 4110425010 | 1050-20 | 90 | 4201029 | 04.240.726.10 |
| 115 | 4012973 | 06.R639007 | ** | 4028358 | 11.R172.146 | 17 | 4110428050 | 01.1200.20 | 89 | 4202314 | 04.240.726.18 |
| 101 | 4012991 | 05.R645002 | 129 | 4028509 | 08.R464002 | ** | 4110428050 | 1040-20 | 89 | 4202332 | 04.240.726.20 |
| 101 | 4013008 | 05.R645013 | ** | 4029634 | 230.303.02.061 | 104 | 4110641 | 05.R557007 | 90 | 4202341 | 04.240.726.16 |
| 82 | 4013017 | 03.R627003 | 90 | 4030144 | 04.R631009 | ** | 4110726810 | 01.1200.10E | 174 | 4214110200 | 10.1883.20 |
| 89 | 4013035 | 04.R240.726.00 | 101 | 4030489 | 05.R645002 | ** | 4111408450 | 01.1150.30 | 174 | 4214110230 | 10.1883.20 |
| 70 | 4013080 | 02.R9000 | 181 | 4030603 | 10.R5210 | 11 | 4111408450 | 01.230.301.8 | 175 | 4214110250 | 10.1883.50 |
| ** | 4013222 | 238.024.02.038 | ** | 4031840 | 01.199.922 | 54 | 4111415012 | 01.391.200 | 175 | 4214113010 | 10.1883.40 |
| 178 | 4013259 | 10.R3350 | 16 | 4031895 | 01.1300.10 | 17 | 4111427110 | 01.1200.15 | 175 | 4214120000 | 10.1883.70 |
| 72 | 4013268 | 02.R584.622 | 178 | 4032095 | 10.R430527 | 17 | 4111428050 | 01.1200.20 | 174 | 4214290000 | 10.285654 |
| ** | 4013277 | 238.024.02.038 | 172 | 4032386 | 10.R4730 | 17 | 4111428160 Con agujero segun plano | 01.1200.15 | 174 | 4214290030 | 10.285654 |
| 70 | 4013286 | 02.R1800E | ** | 4032555 | 01.391.103.4 | 17 | 4111428180 Con agujero segun plano | 01.1200.15 | 173 | 4214440100 | 10.2001.00 |
| ** | 4013295 | 238.024.02.038 | 13 | 4032582 | 01.391.300 | 17 | 4111428190 | 1040-60 | 173 | 4214440200 | 10.2001.00 |
| 89 | 4013307 | 04.R240.726.00 | 129 | 4035402 | 08.R464002 | ** | 4111428190 | 1040-60 | 174 | 4220100012 | 10.R1880 |
| 71 | 4013361 | 02.1616 | 70 | 4035569 | 02.1600.50 | 17 | 4111438050 | 01.1200.20 | 174 | 4220100120 | 10.1880.20 |
| 74 | 4013521 | 02.1831.91 | 67 | 4035578 | 02.3030.30 | 16 | 4111438810 | 01.1200.25 | 174 | 4220100140 | 10.1880.10 |
| 285 | 4013941 | 14.4315.1 | 101 | 4036078 | 05.R645013 | 16 | 4111438810 | 01.1200.25 | 65 | 4230089170 | 02.239.030.1C |
| 182 | 4013978 | 10.R1965 | 80 | 4036108 | 03.R627001 | 11 | 4111470540 | 01.1150.90 | 65 | 4230089190 | 02.239.036.1 |
| 103 | 4014704 | 05.R5090 | 103 | 4037194 | 05.R645010 | 30 | 4111519232 | 01.R391.136 | 65 | 4231020 | 02.239.009.1 |
| ** | 4014768 | 11.R0546.6 | 14 | 4037318 | 01.1300.30 | 30 | 4111540000 | 01.1200.110 | 65 | 4231030 | 02.239.012.1 |
| 72 | 4014825 | 02.R9000N | 121 | 4038069 | 07.R661004 | 30 | 4111540012 | 01.1300.80 | 65 | 4231040 | 02.239.016.1 |
| 90 | 4014928 | 04.240.726.01.0 | ** | 4038199 | 01.R1100E | 15 | 4115227170 | 01.1080.00 | 66 | 4231047100 | 02.239.016.6 |
| ** | 4015866 | 11.R588.997 | ** | 4038201 | 01.R173.701 | 15 | 4115227180 | 01.1070.00 | 65 | 4231050 | 02.239.020.1 |
| 211 | 4015866 | 11.R65.00 | 106 | 4039541 | 05.R712000 | ** | 4115227180 | 60204913 | 65 | 4231054070 | 02.239.020.2 |
| 105 | 4016003 | 05.R657000 | 161 | 4039831 | 10.R611005 | ** | 4120403 | 02.1600.20E | 65 | 4231060 | 02.239.024.1 |
| 93 | 4016160 | 04.R631003 | 107 | 4039840 | 05.R700403 | ** | 4120441 | 02.1600.20E | 65 | 4231061060 | 02.239.024.2 |
| 90 | 4016245 | 04.240.726.41.0 | ** | 4039840 | 11.R2959 | ** | 4122074 | 02.1600.20E | 65 | 4231061440 | 02.239.024.1 |
| 70 | 4016286 | 02.R1800E | 211 | 4039943 | 11.R100.00 | 32 | 4123520100 | 01.1200.185 | 65 | 4231062920 | 02.239.024.1 |
| 72 | 4016432 | 02.R589.757 | ** | 4039943 | 11.R174.226 | 32 | 4123520140 | 01.1200.185 | 65 | 4231070 | 02.239.030.1 |
| 70 | 4016441 | 02.R1800M | ** | 4039998 | 01.178.618 | 32 | 4123529232 | 01.R391.143 | 66 | 4231420010 | 02.1609.00 |
| 70 | 4016469 | 02.R9000E | 195 | 4040770 | 10.975.303 | 41 | 4127040040 | 01.1200.180 | 66 | 4231430010 | 02.1612.00 |
| 70 | 4016469 | 02.R9000E | 203 | 4041010 | 11.R2919 | 41 | 4127040050 | 01.1200.180 | 66 | 4231430020 | 02.1612.10 |
| 73 | 4016786 | 02.2020.06 | 161 | 4041065 | 10.1867.10 | 41 | 4127040080 | 01.1200.180 | 66 | 4231430040 | 02.1612.20 |
| 288 | 4018870 | 14.2545.20 | ** | 4041270 | 01.643.008 | 41 | 4127049322 | 01.1300.120 | 65 | 4240943 | 02.239.024.1C |
| ** | 4019240 | 267.065.00.009 | ** | 4041289 | 01.199.106 | 67 | 4135801 | 02.3030.00 | 65 | 4245144 | 02.239.024.1C |
| ** | 4019268 | 401.926.8 | 143 | 4041391 | 09.R051.107 | 70 | 4140142 | 02.1800.00 | 65 | 4245582 | 02.239.024.1 |
| 184 | 4019295 | 10.R8210 | 93 | 4041421 | 04.R4213 | 70 | 4140160 | 02.1800.00 | 65 | 4245733 | 02.239.024.1 |
| 73 | 4020862 | 02.3000.13 | 107 | 4041430 | 05.R711000 | 70 | 4145231 | 02.1800.00 | 70 | 4253250400 | 02.2080.00 |
| 123 | 4020871 | 07.R661001 | 145 | 4041908 | 09.R051.131 | 67 | 4145866 | 02.2424.00 | 70 | 4253250410 | 02.2080.00 |
| 90 | 4020983 | 04.R240.726.41 | 73 | 4042211 | 02.03561409 | 69 | 4160171 | 02.1216.90 | 70 | 4253250610 | 02.2070.00 |
| | | | 94 | 4042275 | 04.R4214 | 69 | 4160180 | 02.1216.90 | 67 | 4254460020 | 02.1216.30 |
| | | | 124 | 4043609 | 07.529001 | ** | 4170060 | 02.1600.20E | 69 | 4254541120 | 02.1216.90 |

| Pág. WABCO | AIR-FREN | Pág. WABCO | AIR-FREN | Pág. WABCO | AIR-FREN | Pág. WABCO | AIR-FREN | |
|------------|-------------|---------------|----------|-----------------|---------------|------------|--------------------|---------------|
| 69 | 4254541130 | 02.1216.90 | ** | 4329012232 | 432.901.223.2 | 81 | 4600620 | 03.491102 |
| 65 | 4300094 | 02.239.030.1C | 265 | 4332065000 | 13.62173 | 107 | 4600880 | 05.6120.40 |
| 65 | 4305455 | 02.239.030.1 | 263 | 4332065000 | 13.62303 | ** | 4600899 | 1888-00 |
| 65 | 4305512 | 02.239.030.1C | 265 | 4332065010 | 13.62174 | 82 | 4601036 | 03.105510 |
| 65 | 4305549 | 02.239.030.1 | 265 | 4332067000 | 13.62594 | 182 | 4601111 | 10.2950.90 |
| 65 | 4305567 | 02.239.030.1 | 265 | 4332067010 | 13.62593 | ** | 4601157 | 475.800.301.0 |
| 193 | 4320020000 | 10.1100.00 | 265 | 4332067020 | 13.60952 | 191 | 4601335 | 10.579003 |
| 184 | 4321990042 | 10.R8210 | 265 | 4332067030 | 13.60953 | 191 | 4601344 | 10.579004 |
| 184 | 4321990100 | 10.8210.00 | 265 | 4332067040 | 13.62235 | 101 | 4601380 | 05.545003 |
| 184 | 4321990300 | 10.8210.00 | 265 | 4332067050 | 13.62234 | 182 | 4601401 | 10.2950.10 |
| 195 | 4324070000 | 10.484.210 | 265 | 4332067080 | 13.62235 | 103 | 4601410 | 05.605734 |
| 195 | 4324070010 | 10.484.210 | 265 | 4332067090 | 13.62234 | 81 | 4601456 | 03.491102 |
| 195 | 4324070120 | 10.432407.1 | 265 | 4332067100 | 13.60754 | 178 | 4601492 | 10.930.930 |
| 195 | 4324070600 | 10.484.210 | 265 | 4332067110 | 13.60753 | 104 | 4601595 | 05.557007 |
| 195 | 4324070700 | 10.432407 | 288 | 4333003814 | 14.2545.00 | 182 | 4601698 | 10.2950.70 |
| 161 | 4324100002 | 10.R611005 | 288 | 4333003834 | 14.2545.10 | 176 | 4601700 | 10.559001 |
| 161 | 4324100002+ | | 288 | 4333003854 | 14.2545.30 | 182 | 4601764 | 10.2950.40 |
| | 4324100012 | 10.R611004 | ** | 4333020020 | 1888-00 | 183 | 4602189 | 10.3200.30 |
| 161 | 4324100012 | 10.R611006 | 288 | 4334013804 | 14.2545.20 | 101 | 4602273 | 05.545003 |
| 161 | 4324100012+ | | 265 | 4335761240 | 13.62308 | 129 | 4602415 | 08.222.703 |
| | 43241000002 | 10.R611004 | 265 | 4335761250 | 13.62308 | 103 | 4602853 | 05.605733 |
| 161 | 4324100022 | 10.R611005 | 265 | 4335765020 | 13.60953 | 184 | 4603401 | 10.8210.00 |
| 161 | 4324100200 | 10.410103 | 265 | 4335765030 | 13.60952 | 101 | 4603577 | 05.575537 |
| 161 | 4324100202 | 10.1867.10 | 265 | 4335765080 | 13.62039 | 115 | 4603634 | 06.539110 |
| 161 | 4324100210 | 10.410103 | 265 | 4335765090 | 13.62038 | 115 | 4603689 | 06.645.526 |
| 161 | 4324100210 | 10.410103 | 265 | 4335767000 | 13.60753 | 144 | 4603755 Sin muelle | 09.051.102P |
| 161 | 4324100290 | 10.410105 | 265 | 4335767010 | 13.60754 | 81 | 4603849 | 03.491102 |
| 161 | 4324100330 | 10.410104 | 265 | 4335767080 | 13.62174 | 182 | 4603933 | 10.2950.65 |
| 161 | 4324100340 | 10.410104 | 265 | 4335767090 | 13.62173 | 181 | 4603960 | 10.2440.21 |
| ** | 4324100350 | 10.410112 | 265 | 4335767120 | 13.62234 | 123 | 4603979 | 07.045522 |
| 161 | 4324100730 | 10.410104 | 265 | 4335767130 | 13.62235 | 115 | 4604004 | 06.645.526 |
| 161 | 4324100830 | 10.410116 | 265 | 4335767140 | 13.60753 | 181 | 4604031 | 10.2440.22 |
| 161 | 4324101010 | 10.410102 | 265 | 4335767150 | 13.60754 | 129 | 4604040 | 08.933.492 |
| 161 | 4324101020 | 10.410102 | 265 | 4335767240 | 13.62593 | 81 | 4604189 | 03.491102 |
| 161 | 4324101100 | 10.410104 | 265 | 4335767250 | 13.62594 | 184 | 4604291 | 10.8210.00 |
| 161 | 4324101110 | 10.410103 | 183 | 4340140000 | 10.2440.15 | 184 | 4604358 | 10.5676.00 |
| 161 | 4324101160 | 10.410114 | 182 | 4341000002 | 10.R1965 | 181 | 4604442 | 10.2440.23 |
| 161 | 4324101170 | 10.410114 | 182 | 4341000022 | 10.R1965 | 123 | 4604693 | 07.045522 |
| ** | 4324101170 | LA-8209 | 182 | 4341000210 | 10.2950.05 | 123 | 4604910 | 07.045522 |
| 161 | 4324102020 | 10.410102 | 182 | 4341000220 | 10.2950.50 | 123 | 4604938 | 07.045522 |
| 161 | 4324102227 | 10.1867.10 | 182 | 4341000230 | 10.2950.60 | 123 | 4604956 | 07.045522 |
| 162 | 4324102232 | 10.1867.20 | 182 | 4341000250 | 10.2950.10 | 181 | 4604974 | 10.2440.20 |
| 162 | 4324102262 | 10.1867.20 | 182 | 4341000270 | 10.2950.15 | 115 | 4604992 | 06.539110 |
| 161 | 4324102500 | 10.410103 | 182 | 4341000280 | 10.2950.70 | 115 | 4605166 | 06.539110 |
| 161 | 4324102500 | 10.410111 | 182 | 4341000290 | 10.2950.40 | 176 | 4605193 | 10.559001 |
| 162 | 4324109262 | 10.1867.20 | 182 | 4341000330 | 10.2950.00 | 106 | 4605269 | 05.533001 |
| 162 | 4324109272 | 10.1867.20 | 182 | 4341000440 | 10.2950.25 | 11 | 4605326 | 01.1150.90 |
| 161 | 4324200000 | 10.410106 | 182 | 4341000800 | 10.2950.40 | 11 | 4605335 | 01.230.301.7 |
| 161 | 4324200010 | 10.410106 | 182 | 4341001220 | 10.2950.35 | ** | 4605371 | 05.3750.00 |
| 161 | 4324200020 | 10.410106 | 182 | 4341001240 | 10.2950.75 | 105 | 4605410 | 05.557001 |
| 161 | 4324210000 | 10.410106 | 182 | 4341001250 | 10.2950.90 | 176 | 4605643 | 10.559002 |
| 161 | 4324210002 | 10.R611005 | 182 | 4341001260 | 10.2950.20 | 90 | 4605764 | 04.565590 |
| 161 | 4324210020 | 10.410106 | 182 | 4341001290 | 10.2950.45 | 182 | 4605906 | 10.2950.70 |
| 204 | 4324310002 | 11.R2929 | 182 | 4341001300 | 10.2950.55 | 81 | 4606031 | 03.491102 |
| 164 | 4324310012 | 10.R431100 | 182 | 4341001360 | 10.2950.65 | 115 | 4606059 | 06.539110 |
| 164 | 4324310022 | 10.R431100 | 182 | 4341001370 | 10.2950.75 | 183 | 4606264 | 10.4375.10 |
| 164 | 4324310080 | 10.431100 | 182 | 4341002000 | 10.2950.80 | 81 | 4606303 | 03.491102 |
| 164 | 4324311910 | 10.431100 | 182 | 4341002200 | 10.2950.80 | 80 | 4606424 | 03.527001 |
| 178 | 4325000000 | 10.930.930 | 182 | 4341002250 | 10.2950.25 | 181 | 4606497 | 10.5210.60 |
| 178 | 4325000200 | 10.930.930 | 182 | 4341002360 | | 182 | 4606518 | 10.2950.60 |
| 185 | 4325110000 | 10.511000 | | Tara 1,1 BAR | 10.2950.15 | 115 | 4606563 | 06.539110 |
| 185 | 4325110010 | 10.511000 | 183 | 4342000030 | 10.3200.30 | 191 | 4606611 | 10.579005 |
| 61 | 4326030000 | 01.7000.10 | 183 | 4342020000 | 10.3200.60 | 191 | 4606639 | 10.579006 |
| 162 | 4329012232 | 10.1867.70 | ** | 4342020002 | 10.R3200E | 191 | 4606657 | 10.579013 |
| | | | 183 | 4342020012 | 10.R3200E | | | |
| | | | 183 | 4342021000 | 10.3200.60 | | | |
| | | | 183 | 4342080000 | 10.3200.30 | | | |
| | | | 183 | 4342080090 + | | | | |
| | | | | 3 Racor 5000164 | 10.3200.30 | | | |
| | | | 183 | 4342080280 + | | | | |
| | | | | 3 Racor 5000164 | 10.3200.30 | | | |
| | | | 183 | 4342080290 | 10.3200.30 | | | |
| | | | 178 | 4343000000 | 10.055527 | | | |
| | | | 178 | 4343000002 | 10.R430527 | | | |
| | | | 188 | 4345000000 | 10.3200.50 | | | |
| | | | 188 | 4345000030 | 10.3200.50 | | | |
| | | | 181 | 4346020010 | 10.2440.21 | | | |
| | | | 181 | 4346082200 | 10.763.775 | | | |
| | | | 185 | 4406091 | 10.5018.10 | | | |
| | | | 186 | 4410324430 | 10.4420.40 | | | |
| | | | 186 | 4410325730 | 10.4420.100 | | | |
| | | | 186 | 4410328080 | 10.4410.40 | | | |
| | | | 186 | 4410328090 | 10.4410.100 | | | |
| | | | 186 | 4410329212 | 10.4410.40 | | | |
| | | | 186 | 4410329222 | 10.4410.100 | | | |
| | | | 186 | 4410329632 | 10.4420.40 | | | |
| | | | 131 | 4410500080 | 08.4410.70 | | | |
| | | | 131 | 4410500100 | 08.4410.60 | | | |
| | | | 131 | 4410500110 | 08.4410.50 | | | |
| | | | 164 | 4420191351 | 10.432200 | | | |
| | | | ** | 4461080400 | 10.4461.00 | | | |
| | | | ** | 4461089202 | 10.4461.00 | | | |
| | | | 187 | 4494110050 | 10.4494.10 | | | |
| | | | 187 | 4494440220 | 10.4494.20 | | | |
| | | | 62 | 4519993962 | 01.3960.00 | | | |
| | | | 182 | 4520020092 | 10.R3800E | | | |
| | | | 182 | 4520021000 | 10.4395.10 | | | |
| | | | 182 | 4520021070 | 10.4395.20 | | | |
| | | | 191 | 4522000110 | 10.579003 | | | |
| | | | 191 | 4522000120 | 10.579004 | | | |
| | | | 191 | 4522002110 | 10.579011 | | | |
| | | | 191 | 4522002120 | 10.579012 | | | |
| | | | 32 | 4523520110 | 01.1200.185 | | | |
| | | | 32 | 4523520150 | 01.1200.185 | | | |
| | | | 191 | 4527110010 | 10.3500.22R | | | |
| | | | 191 | 4527110020 | 10.3500.22A | | | |
| | | | 191 | 4527110110 | 10.3500.16R | | | |
| | | | 191 | 4527110120 | 10.3500.16A | | | |
| | | | 191 | 4527110140 | 10.3500.16R | | | |
| | | | 191 | 4527110150 | 10.3500.16A | | | |
| | | | 191 | 4527110210 | 10.3500.18R | | | |
| | | | 191 | 4527110220 | 10.3500.18A | | | |
| | | | 192 | 4528020070 | 10.579014 | | | |
| | | | 192 | 4528020090 | 10.579014 | | | |
| | | | 192 | 4528040120 | 10.579015 | | | |
| | | | 191 | 4528060000 | 10.579022 | | | |
| | | | 191 | 4528080020 | 10.579023 | | | |
| | | | 101 | 4600022 | 05.575537 | | | |
| | | | 101 | 4600068 | 05.545003 | | | |
| | | | 93 | 4600116 | 04.4211.00 | | | |
| | | | 93 | 4600116 | 04.R631003 | | | |
| | | | 105 | 4600134 | 05.557004 | | | |
| | | | 183 | 4600143 | 10.2440.15 | | | |
| | | | 178 | 4600170 | 10.543002 | | | |
| | | | 182 | 4600189 | 10.2950.65 | | | |
| | | | 115 | 4600424 | 06.645.526 | | | |
| | | | 81 | 4600527 | 03.491102 | | | |
| | | | 183 | 4600545 | 10.8321.00 | | | |

CRUCE DE REFERENCIAS: REFERENCIAS ORIGINALES / AIR FREN

CROSS REFERENCE LIST: ORIGINAL REFERENCES / AIR FREN

| Pág. WABCO | AIR-FREN | Pág. WABCO | AIR-FREN | Pág. WABCO | AIR-FREN | Pág. WABCO | AIR-FREN | |
|------------|--------------------|--------------|-----------------------|------------|-------------|-----------------------|------------|-------------|
| 178 | 4606705 | 10.055527 | 129 | 4612854 | 08.933.492 | 80 | 4613150640 | 03.527001 |
| 178 | 4606705 | 10.055527 | 106 | 4612863 | 05.533001 | 80 | 4613150640 | 03.527003 |
| 81 | 4606808 | 03.491102 | 143 | 4612939 | 09.051.107P | 80 | 4613150650 | 03.527001 |
| 115 | 4606826 | 06.539110 | 82 | 4613070022 | 03.R627003 | 80 | 4613150650 | 03.527003 |
| 123 | 4606844 | 07.045522 | 82 | 4613072000 | 03.105510 | 80 | 4613150760 | 03.527001 |
| 185 | 4607081 | 10.511000 | 82 | 4613072020 | 03.105510 | 80 | 4613150760 | 03.527003 |
| 129 | 4607102 | 08.933.492 | 82 | 4613072040 | 03.105510 | 80 | 4613150770 | 03.527001 |
| 106 | 4607166 | 05.533001 | 82 | 4613073700 | 03.105510 | 80 | 4613150770 | 03.527003 |
| 144 | 4607193 Con muelle | 09.051.102P | 82 | 4613074000 | 03.105508 | 80 | 4613150860 | 03.527001 |
| 144 | 4607214 Sin muelle | 09.051.102P | 82 | 4613074190 | 03.105508 | 80 | 4613150860 | 03.527003 |
| 182 | 4607228 | 10.4395.10 | 82 | 4613074390 | 03.105509 | 80 | 4613151500 | 03.527001 |
| 101 | 4607269 | 05.545003 | 82 | 4613074580 | 03.105508 | 80 | 4613151500 | 03.527003 |
| 81 | 4607513 | 03.491102 | 82 | 4613074590 | 03.105509 | 80 | 4613151500 | 03.527003 |
| 123 | 4607746 | 07.055522 | 82 | 4613074670 | 03.105508 | 80 | 4613151540 | 03.527001 |
| 123 | 4607764 | 07.045522 | 82 | 4613074750 | 03.105508 | 80 | 4613151540 | 03.527003 |
| 82 | 4607803 | 03.105510 | 82 | 4613074760 | 03.105508 | 80 | 4613151550 | 03.527001 |
| 155 | 4607885 | 09.1883.60 | 82 | 4613074790 | 03.105508 | 80 | 4613151550 | 03.527003 |
| ** | 4608067 | 09.460.806 | 82 | 4613075200 | 03.105510 | 81 | 4613151800 | 03.527006 |
| 143 | 4608068 | 09.051.107P | 82 | 4613075210 | 03.105510 | 84 | 4613152480 | 03.527015 |
| ** | 4608068 | 09.460.806 | 161 | 4613103 | 10.410106 | 84 | 4613152540 | 03.527016 |
| 175 | 4608330 | 10.786.653 | 79 | 4613130500 | 03.1900.20 | 84 | 4613152580 | 03.527016 |
| 82 | 4608376 | 03.105508 | 85 | 4613130500 | 03.527020 | 85 | 4613152630 | 03.527025 |
| 181 | 4608518 | 10.2440.19 | 79 | 4613130550 | 03.1900.20 | Con diffe. silencioso | 03.527025 | |
| 13 | 4608965 | 01.772.590 | 85 | 4613130550 | 03.527020 | 85 | 4613152640 | 03.527025 |
| 172 | 4609166 | 10.4730.00 | 106 | 4613149 | 05.533005 | 80 | 4613154740 | 03.527001 |
| 16 | 4609223 Tapa ciega | 01.1200.10 | 80 | 4613150032 | 03.R627001 | 80 | 4613154740 | 03.527003 |
| 173 | 4609577 | 10.4750.00 | 80 | 4613150040 | 03.527001 | 80 | 4613154750 | 03.527001 |
| 129 | 4609719 | 08.222.703 | 80 | 4613150040 | 03.527001 | 80 | 4613154790 | 03.527001 |
| 115 | 4609755 | 06.539110 | 80 | 4613150040 | 03.527003 | 80 | 4613154790 | 03.527003 |
| 101 | 4609773 | 05.575537 | 80 | 4613150052 | 03.R627001 | 80 | 4613154820 | 03.527001 |
| 173 | 4609979 | 10.4750.00 | 80 | 4613150080 | 03.527001 | 80 | 4613154820 | 03.527003 |
| 80 | 4611010000 | 03.240.654.0 | 80 | 4613150080 | 03.527003 | 80 | 4613154910 | 03.527001 |
| 121 | 4611103 | 07.561001 | 80 | 4613150090 | 03.527001 | 80 | 4613154910 | 03.527003 |
| 121 | 4611149 | 07.561002 | 80 | 4613150090 | 03.527003 | 80 | 4613154950 | 03.527001 |
| 14 | 4611251 | 01.772.951 | 80 | 4613150120 | 03.527001 | 80 | 4613154950 | 03.527003 |
| 14 | 4611279 | 01.772.951 | 80 | 4613150120 | 03.527003 | 80 | 4613154970 | 03.527001 |
| 14 | 4611309 | 01.772.956 | 80 | 4613150160 | 03.527001 | 80 | 4613154970 | 03.527003 |
| 14 | 4611318 | 01.772.951 | 80 | 4613150170 | 03.527001 | 205 | 4613159002 | 11.R2931 |
| 14 | 4611327 | 01.772.951 | 80 | 4613150170 | 03.527003 | 205 | 4613159012 | 11.R2931 |
| 14 | 4611336 | 01.568.840 | 80 | 4613150190 | 03.527001 | 81 | 4613159072 | 03.R527006 |
| 107 | 4611372 | 05.700000 | 80 | 4613150190 | 03.527001 | 84 | 4613159202 | 03.R527015 |
| 14 | 4611402 | 01.772.938 | 80 | 4613150190 | 03.527003 | 81 | 4613159242 | 03.R527006 |
| 14 | 4611420 | 01.772.950 | 80 | 4613150210 | 03.527001 | 81 | 4613170540 | 03.527008 |
| 14 | 4611448 | 01.772.951 | 80 | 4613150210 | 03.527003 | 80 | 4613190012 | 03.R627002 |
| 14 | 4611466 | 01.772.952 | 80 | 4613150230 | 03.527001 | 84 | 4613190022 | 03.R527021 |
| 14 | 4611484 | 01.772.956 | 80 | 4613150230 | 03.527003 | 84 | 4613190042 | 03.R527021 |
| 80 | 4611493 | 03.527001 | 80 | 4613150260 | 03.527001 | 84 | 4613190062 | 03.R527021 |
| 121 | 4611523 | 07.561001 | 80 | 4613150260 | 03.527003 | 80 | 4613190072 | 03.R627002 |
| 193 | 4611608 | 10.4115.00 | 80 | 4613150270 | 03.527001 | 80 | 4613190080 | 03.527004 |
| 11 | 4611747 | 01.230.301.7 | 80 | 4613150270 | 03.527003 | 84 | 4613192500 | 03.527022 |
| 129 | 4611756 | 08.933.492 | 80 | 4613150300 | 03.527001 | 84 | 4613192600 | 03.527023 |
| 13 | 4611822 | 01.774.951 | 80 | 4613150300 | 03.527003 | 84 | 4613192700 | 03.527023 |
| 161 | 4611859 | 10.410102 | 80 | 4613150360 | 03.527001 | 84 | 4613192700 | 03.527023 |
| 173 | 4611877 | 10.9640.00 | 80 | 4613150360 | 03.527001 | 84 | 4613192720 | 03.527023 |
| 183 | 4611916 | 10.2440.15 | 80 | 4613150360 | 03.527003 | 84 | 4613192740 | 03.527021 |
| 103 | 4611925 | 05.235546 | 80 | 4613150420 | 03.527001 | 129 | 4613224 | 08.222.703 |
| 106 | 4612199 | 05.712000 | 80 | 4613150420 | 03.527003 | 79 | 4613230700 | 03.1900.00 |
| 129 | 4612274 | 08.933.492 | 80 | 4613150610 | 03.527001 | 176 | 4613233 | 10.559001 |
| 103 | 4612331 | 05.2750.80 | 80 | 4613150610 | 03.527001 | 84 | 4613240002 | 03.R527018 |
| 103 | 4612340 | 05.2750.90 | 80 | 4613150610 | 03.527003 | 84 | 4613240160 | 03.527017 |
| 129 | 4612489 | 08.222.703 | 80 | 4613150630 | 03.527001 | 80 | 4613242 | 03.527001 |
| 93 | 4612546 | 04.4213.00 | 80 | 4613150630 | 03.527001 | 80 | 4613242 | 03.527003 |
| 93 | 4612546 | 04.4213.00 | 80 | 4613150630 | 03.527003 | 84 | 4613245200 | 03.527018 |
| 183 | 4612776 | 10.2440.15 | 80 | 4613150640 | 03.527001 | 84 | 4613245210 | 03.527018 |
| 138 | 4613372 | 08.5857241 | 80 | 4613150640 | 03.527001 | 138 | 4613372 | 08.5857241 |
| 13 | 4613431 | 01.774.951 | 80 | 4613150640 | 03.527003 | 13 | 4613431 | 01.774.951 |
| 13 | 4613439 | 01.774.951 | 80 | 4613150650 | 03.527001 | 13 | 4613439 | 01.774.951 |
| 183 | 4613550 | 10.2440.15 | 80 | 4613150650 | 03.527003 | 183 | 4613550 | 10.2440.15 |
| 121 | 4613578 | 07.561002 | 80 | 4613150760 | 03.527001 | 121 | 4613578 | 07.561002 |
| ** | 4613578 | 500002009 | 80 | 4613150760 | 03.527003 | ** | 4613578 | 500002009 |
| ** | 4613662 | 06.539120 | 80 | 4613150770 | 03.527001 | ** | 4613662 | 06.539120 |
| 80 | 4613822 | 03.527001 | 80 | 4613150770 | 03.527003 | 80 | 4613822 | 03.527001 |
| 141 | 4613868 | 09.051.114 | 80 | 4613150860 | 03.527001 | 141 | 4613868 | 09.051.114 |
| 149 | 4613877 | 09.051.102 | 80 | 4613150860 | 03.527003 | 149 | 4613877 | 09.051.102 |
| 145 | 4613886 | 09.051.111 | 80 | 4613151500 | 03.527001 | 145 | 4613886 | 09.051.111 |
| 146 | 4614040 | 09.051.131 | 80 | 4613151500 | 03.527003 | 146 | 4614040 | 09.051.131 |
| 84 | 4614201 | 03.527018 | 80 | 4613151500 | 03.527003 | 84 | 4614201 | 03.527018 |
| 130 | 4614238 | 08.8010.40 | 80 | 4613151540 | 03.527001 | 130 | 4614238 | 08.8010.40 |
| 104 | 4614283 | 05.2458.50 | 80 | 4613151540 | 03.527003 | 104 | 4614283 | 05.2458.50 |
| 149 | 4614340 | 09.051.107 | 80 | 4613151550 | 03.527001 | 149 | 4614340 | 09.051.107 |
| 149 | 4614416 | 09.051.124 | 80 | 4613151550 | 03.527003 | 149 | 4614416 | 09.051.124 |
| 143 | 4614443 | 09.051.107P | 81 | 4613151800 | 03.527006 | 143 | 4614443 | 09.051.107P |
| 82 | 4614452 | 03.3070.10 | 84 | 4613152480 | 03.527015 | 82 | 4614452 | 03.3070.10 |
| 103 | 4614564 | 05.2458.49 | 84 | 4613152540 | 03.527016 | 103 | 4614564 | 05.2458.49 |
| 184 | 4614902 | 10.8210.00 | 84 | 4613152580 | 03.527016 | 184 | 4614902 | 10.8210.00 |
| 81 | 4614911000 | 03.491102 | 85 | 4613152630 | 03.527025 | 81 | 4614911000 | 03.491102 |
| 81 | 461491102 0 | 03.491102 | Con diffe. silencioso | 03.527025 | 81 | 461491102 0 | 03.491102 | |
| 81 | 4614911520 | 03.491102 | 85 | 4613152640 | 03.527025 | 81 | 4614911520 | 03.491102 |
| 81 | 4614912000 | 03.491102 | 80 | 4613154740 | 03.527001 | 81 | 4614912000 | 03.491102 |
| 81 | 4614912740 | 03.491102 | 80 | 4613154740 | 03.527003 | 81 | 4614912740 | 03.491102 |
| ** | 4614990000 | 03.3050.00 | 80 | 4613154750 | 03.527001 | ** | 4614990000 | 03.3050.00 |
| 207 | 4614990002 | 11.R2951 | 80 | 4613154790 | 03.527001 | 207 | 4614990002 | 11.R2951 |
| 130 | 4615000 | 08.8010.40 | 80 | 4613154790 | 03.527003 | 130 | 4615000 | 08.8010.40 |
| 130 | 4615073 | 08.3032.00 | 80 | 4613154820 | 03.527001 | 130 | 4615073 | 08.3032.00 |
| 135 | 4615073 | 08.3111.00 | 80 | 4613154820 | 03.527003 | 135 | 4615073 | 08.3111.00 |
| 107 | 4615167 | 05.714000 | 80 | 4613154910 | 03.527001 | 107 | 4615167 | 05.714000 |
| 106 | 4617130 | 05.533001 | 80 | 4613154910 | 03.527003 | 106 | 4617130 | 05.533001 |
| ** | 4617224222 | 04.R565597 | 80 | 4613154950 | 03.527001 | ** | 4617224222 | 04.R565597 |
| 103 | 4620118 | 05.2458.49 | 80 | 4613154950 | 03.527003 | 103 | 4620118 | 05.2458.49 |
| 204 | 4620120012 | 11.R2925 | 80 | 4613154970 | 03.527001 | 204 | 4620120012 | 11.R2925 |
| 204 | 4620120022 | 11.R2926 | 80 | 4613154970 | 03.527003 | 204 | 4620120022 | 11.R2926 |
| 176 | 4630130100 | 10.559003 | 205 | 4613159002 | 11.R2931 | 176 | 4630130100 | 10.559003 |
| 176 | 4630130120 | 10.559001 | 205 | 4613159012 | 11.R2931 | 176 | 4630130120 | 10.559001 |
| 176 | 4630130140 | 10.559002 | 81 | 4613159072 | 03.R527006 | 176 | 4630130140 | 10.559002 |
| 176 | 4630131100 | 10.559003 | 84 | 4613159202 | 03.R527015 | 176 | 4630131100 | 10.559003 |
| 176 | 4630131120 | 10.559001 | 81 | 4613159242 | 03.R527006 | 176 | 4630131120 | 10.559001 |
| 176 | 4630131140 | 10.559002 | 81 | 4613170540 | 03.527008 | 176 | 4630131140 | 10.559002 |
| 176 | 4630131160 | 10.559003 | 80 | 4613190012 | 03.R627002 | 176 | 4630131160 | 10.559003 |
| 176 | 4630131270 | 10.559001 | 84 | 4613190022 | 03.R527021 | 176 | 4630131270 | 10 |



| Pág. | WABCO | AIR-FREN | Pág. | WABCO | AIR-FREN | Pág. | WABCO | AIR-FREN | Pág. | WABCO | AIR-FREN |
|------|------------|----------------|------|--------------------------|-------------------|------|------------|---------------|------|------------|-------------|
| 169 | 4630460030 | 10.4600.40 | 185 | 4721959212 | 10.5018.10 | 106 | 4757101300 | 05.533001 | 71 | 8971206154 | 02.1614L |
| 169 | 4630460040 | 10.4600.40 | 209 | 4729000022 | 11.R2961 | 106 | 4757101310 | 05.533005 | 71 | 8971218464 | 02.1627L |
| 208 | 4630490002 | 11.R2956 | 209 | 4729000052 | 11.R2962 | 106 | 4757101360 | 05.533010 | 71 | 8971219224 | 02.1622L |
| 208 | 4630550022 | 11.R2957 | 209 | 4729050032 | 11.R2963 | ** | 4757110000 | 05.711.000 | 71 | 8971219234 | 02.1216 |
| 169 | 4630620000 | 10.7060.00 | 209 | 4729050042 | 11.R2964 | 107 | 4757110002 | 05.R711000 | 285 | 8975500204 | 14.4315 |
| 169 | 4630630002 | 10.R6300 | 101 | 4730170000 | 05.575537 | 107 | 4757110240 | 05.711000 | 18 | 9115010100 | 01.1200.30 |
| 169 | 4630630020 | 10.6300.00 | 101 | 4730170002 | 05.R645013 | 107 | 4757110260 | 05.711000 | ** | 9115010100 | CD 419 |
| 169 | 4630630030 | 10.6300.10 | 101 | 4730170300 | 05.575537 | 107 | 4757110360 | 05.711000 | 19 | 9115010110 | 01.1200.35 |
| 177 | 4630840000 | 10.8400.00 | 70 | 4730787 | 02.1800.00 | ** | 4757110390 | 05.711.000 | 18 | 9115010150 | 01.1200.30 |
| ** | 4632034 | 10.931.235 | 178 | 4735010000 | 10.543002 | 107 | 4757110510 | 05.711000 | 19 | 9115010160 | 01.1200.35 |
| 174 | 4632070 | 10.772.642 | 178 | 4735012010 | 10.543002 | 107 | 4757110720 | 05.711000 | 20 | 9115010500 | 01.1200.40 |
| 290 | 4637031000 | 14.7031.00 | 181 | 4750100002 | 10.R5210 | ** | 4757110740 | 05.711.000 | 21 | 9115010510 | 01.1200.45 |
| 129 | 4640020052 | 08.R464003 | 181 | 4750100010 | 10.5210.80 | ** | 4757110750 | 05.711.000 | 20 | 9115010600 | 01.1200.40 |
| 129 | 4640020082 | 08.R464002 | 180 | 4750100012 | 10.R5410 | 107 | 4757111260 | 05.711000 | 21 | 9115010610 | 01.1200.45 |
| 129 | 4640023100 | 08.933.492 | 181 | 4750100020 | 10.5210.10 | 107 | 4757111340 | 05.711000 | ** | 9115010620 | 60204913 |
| 129 | 4640023300 | 08.933.492 | 180 | 4750100022 | 10.R5010 | 107 | 4757111430 | 05.711000 | 18 | 9115018002 | 01.1300.25 |
| 129 | 4640023320 | 08.222.703 | 181 | 4750100060 | 10.5210.80 | 106 | 4757120000 | 05.712000 | 19 | 9115018012 | 01.1300.35 |
| 129 | 4640024400 | 08.933.492 | 181 | 4750100130 | 10.5210.60 | 106 | 4757120002 | 05.R712000 | 23 | 9115038052 | 01.1300.85 |
| ** | 4640024410 | SV-1395 | 180 | 4750102000 | 10.5410.00 | 107 | 4757140002 | 05.R714000 | 22 | 9115040510 | 01.1200.50 |
| 129 | 4640025030 | 08.222.703 | 180 | 4750103000 | 8.5 BAR | 107 | 4757145000 | 05.714000 | 22 | 9115040520 | 01.1200.50 |
| 133 | 4640025320 | 08.1294.00 | | | 10.5410.00 | ** | 4757145000 | 602.005.001 | 23 | 9115040560 | 01.1200.55 |
| 129 | 4640040000 | 08.4640.00 | 180 | 4750103010 | 10 BAR | 106 | 4757150002 | 05.R715000 | 25 | 9115040590 | 01.1200.130 |
| 138 | 4640050002 | 08.R005000 | | | 10.5410.00 | 106 | 4757155000 | 05.715000 | 25 | 9115040600 | 01.1200.130 |
| 191 | 4640050010 | 10.579012 | 180 | 4750104000 | 10.5010.00 | 106 | 4757155070 | 05.715000 | 26 | 9115045000 | 01.1200.170 |
| 138 | 4640050040 | 08.5857241 | 181 | 4750150010 | 10.5310.80 | 106 | 4757155110 | 05.715000 | 22 | 9115045002 | 01.391.800 |
| 138 | 4640050050 | 08.5857240 | 181 | 4750150012 | 10.R5310 | 106 | 4757155130 | 05.715000 | 26 | 9115045010 | 01.1200.170 |
| 129 | 4640060000 | 08.8010.30 | 180 | 4750150050 | 10.5310.100 | 106 | 4757155140 | 05.715000 | 26 | 9115045030 | 01.1200.170 |
| 129 | 4640060002 | 08.R8015 | 181 | 4750150160 | 10.5310.80 | 106 | 4757155200 | 05.715000 | 26 | 9115045040 | 01.1200.170 |
| 130 | 4640060010 | 08.8010.40 | 181 | 4750150280 | 10.5310.80 | ** | 4770866 | 04.R565597 | 26 | 9115045060 | 01.1200.170 |
| 130 | 4640060012 | 08.R8016 | 180 | 4750150350 | 10.5310.100 | 71 | 4780353 | 02.1601L | 22 | 9115046502 | 01.1300.115 |
| 130 | 4640060020 | 08.8010.40 | 181 | 4750150360 | (6.7BAR) | 71 | 4780362 | 02.1802L | 26 | 9115049202 | 01.1300.125 |
| ** | 4640060020 | SV-1395 | | | 10.5310.80 | 71 | 4780371 | 02.1651L | 20 | 9115050500 | 01.1200.40 |
| 130 | 4640060110 | 08.8010.40 | 181 | 4750150390-8.5 BAR | 10.5310.80 | 173 | 5710030020 | 10.0030.02 | 21 | 9115050510 | 01.1200.45 |
| 130 | 4640061000 | 08.8010.50 | 181 | 4750150630 | (8,5BAR) | 173 | 5710031040 | 10.0030.04 | 35 | 9115051500 | 01.1200.70 |
| ** | 4640061000 | SV-1410 | | | 10.5310.80 | 184 | 6404273 | 10.8210.00 | 35 | 9115051510 | 01.1200.70 |
| 132 | 4640070010 | 08.8010.80 | 181 | 4750155000 | 10.5310.80 | 125 | 7201990008 | 07.R1335 | 20 | 9115058002 | 01.1300.40 |
| 132 | 4640070020 | 08.8010.60 | 123 | 4753040092 | 07.R661005 | 208 | 7202040008 | 11.R2958 | 35 | 9115058012 | 01.1300.50 |
| 132 | 4640070100 | 08.8010.70 | 123 | 4753042010 | 07.561003 | 208 | 7202160008 | 11.R2958 | 35 | 9115058042 | 01.1300.50 |
| 132 | 4640070110 | 08.8010.90 | 103 | 4756040022 | 05.R5090 | ** | 8840483382 | 432.901.223.2 | 75 | 9210030000 | 02.1350.20 |
| 132 | 4640070130 | 08.8010.80 | 103 | 4756040110 | 05.605734 | 132 | 8846082370 | 08.8010.90 | 75 | 9210040000 | 02.1400.10 |
| ** | 4640325320 | SV-1294 | 103 | 4756040130 | 05.605733 | 67 | 8901103280 | 02.2020.00 | 67 | 9253000030 | 02.2020.00 |
| 16 | 4640512 | 01.1200.10 | 107 | 4757000042 | 05.R700403 | 147 | 8901313320 | 09.R1605 | 67 | 9253000460 | 02.2020.00 |
| 288 | 4684440 | 14.2545.10 | ** | 4757000042 | 11.R2959 | 168 | 8942600402 | 10.410200 | 67 | 9253030000 | 02.3630.00 |
| 82 | 4700120000 | 03.3070.10 | 107 | 4757004030 | 05.700000 | 168 | 8942600432 | 10.410210 | 203 | 9253200012 | 11.R2920 |
| 82 | 4700125202 | 03.3070.20 | ** | 4757004030 | 602.005.001 | ** | 8942600442 | 10.410230 | 204 | 9253200022 | 11.R2921 |
| 108 | 4710050092 | 05.R557005 | 107 | 4757010010 | 05.6120.40 | 168 | 8942600472 | 10.410215 | 67 | 9253201390 | 02.2024.00 |
| 108 | 4710050200 | 05.557005 | 107 | 4757010200 | 05.6120.50 | 168 | 8942600492 | 10.410205 | 67 | 9253201540 | 02.2024.00 |
| 172 | 4720020092 | 10.R4720 | 288 | 4757017122 | 14.2545.40 | 163 | 8946004512 | 10.410100 | 67 | 9253202500 | 02.2024.00 |
| 172 | 4720023020 | 10.4720.00 | ** | 4757027102 | 14.2545.50 | 185 | 8946011322 | 10.8946.00 | 67 | 9253204010 | 02.2030.00 |
| 172 | 4720170002 | 10.R4730 | 106 | 4757100000 | 05.533001 | 71 | 8971204954 | 02.1609 | 67 | 9253204040 | 02.2030.00 |
| 172 | 4720174800 | 10.4730.00 | 106 | 4757100012 | 05.R633001 | 71 | 8971205054 | 02.1612 | 67 | 9253205000 | 02.2030.00 |
| 173 | 4721001010 | 10.4750.10 | 106 | 4757100030 | 05.533001 | 71 | 8971205074 | 02.1612L | 67 | 9253205020 | 02.2030.00 |
| 173 | 4721231080 | 10.4750.00 | 106 | 4757100070 | Girar tapa 90° | 71 | 8971205104 | 02.1616 | 67 | 9253209740 | 02.2024.30 |
| 173 | 4721241080 | 10.4750.00 | | | 05.533005 | 71 | 8971205164 | 02.1616L | 67 | 9253209790 | 02.2030.30 |
| 173 | 4721706000 | 10.4750.00 | 106 | 4757100110 | 05.533001 | 71 | 8971205204 | 02.1601 | 67 | 9253209890 | 02.2030.30 |
| 185 | 4721950040 | 10.5018.10 | 106 | 4757100200 | 05.533001 | 71 | 8971205264 | 02.1601L | 67 | 9253211060 | 02.2424.00 |
| 185 | 4721950080 | Con bocas VOSS | 106 | 4757100240 | 05.533005 | 71 | 8971205304 | 02.1802 | 67 | 9253211630 | 02.2424.00 |
| | | 10.5018.00 | 106 | 4757100250 | Ver observaciones | 71 | 8971205354 | 02.1802W | 67 | 9253212020 | 02.2424.00 |
| 185 | 4721950180 | 10.5018.00 | | | 05.533001 | 71 | 8971205364 | 02.1802L | 67 | 9253212880 | 02.2424.00 |
| 186 | 4721950200 | 10.5031.00 | 106 | 4757100360-3-M16-22VOSS- | | 71 | 8971205404 | 02.1651 | 67 | 9253212970 | 02.2424.00 |
| 186 | 4721950310 | 10.5031.00 | | | 05.533001 | 71 | 8971205464 | 02.1651L | 67 | 9253214000 | 02.2430.00 |
| 185 | 4721950400 | 10.5040.10 | 106 | 4757100400 | 05.533005 | 71 | 8971205474 | 02.1627W | 67 | 9253221250 | 02.3030.00 |
| 185 | 4721950410 | 10.5040.00 | 106 | 4757101040 | 05.533005 | 71 | 8971205504 | 02.1636L | 67 | 9253221320 | 02.3030.00 |
| 185 | 4721950970 | 10.5018.00 | 106 | 4757101280 | 05.533001 | 71 | 8971206104 | 02.1614 | 67 | 9253221330 | 02.3030.00 |

CRUCE DE REFERENCIAS: REFERENCIAS ORIGINALES / AIR FREN

CROSS REFERENCE LIST: ORIGINAL REFERENCES / AIR FREN

| Pág. WABCO | AIR-FREN | Pág. WABCO | AIR-FREN | Pág. WABCO | AIR-FREN | Pág. WABCO | AIR-FREN | |
|------------|---------------------|-------------|----------|-------------|------------|------------|---------------|---------------|
| 67 | 9253221550 | 02.3030.00 | 67 | 9254540010 | 02.1624.00 | 116 | 9347050020 | 06.559150 |
| 67 | 9253221570 | 02.3030.00 | 69 | 9254601020 | 02.2024.60 | ** | 9347050050 | AE-4510 |
| 67 | 9253222050 | 02.3030.00 | 69 | 9254610100 | 02.2424.60 | 116 | 9347140100 | 06.559130 |
| 67 | 9253222150 | 02.3030.00 | 69 | 9254610700 | 02.2424.60 | 116 | 9347140102 | 06.R559130 |
| 67 | 9253222240 | 02.3030.00 | 69 | 9254644500 | 02.1616.60 | 116 | 9347140280 | 06.559130 |
| 67 | 9253222410 | 02.3030.00 | 69 | 9254644510 | 02.1616.60 | 116 | 9347141190 | 06.559130 |
| 67 | 9253222510 | 02.3030.00 | 69 | 9254644520 | 02.1616.60 | 116 | 9347141280 | 06.559130 |
| 67 | 9253224230 | 02.3030.00 | 69 | 9254644530 | 02.1616.60 | 116 | 9347142110 | 06.559130 |
| 67 | 9253224240 | 02.3030.00 | 69 | 9254644600 | 02.1616.60 | 115 | 9349010052 | 06.R559120 |
| 67 | 9253224330 | 02.3030.00 | 69 | 9254644610 | 02.1616.60 | 62 | 95006000400 | 01.3960.60 |
| 67 | 9253226110 | 02.3024.00 | 69 | 9254645000 | 02.1624.60 | 62 | 9501050010 | 01.2590.05 |
| 67 | 9253229070 | 02.3030.00 | 69 | 9254645010 | 02.1624.60 | 62 | 9501050040 | 01.2590.05 |
| 67 | 9253229500 | 02.3030.30 | 69 | 9254645040 | 02.1624.60 | 191 | 9520000210 | 10.579009 |
| 67 | 9253229640 | 02.3030.30 | 69 | 9254645090 | 02.1624.60 | 191 | 9520000220 | 10.579010 |
| 67 | 9253229660 | 02.3030.30 | 69 | 9254810120 | 02.2424.60 | 191 | 9522000210 | 10.579001 |
| 67 | 9253229660 | 02.3030.30 | 203 | 9320020022 | 11.R2919 | 191 | 9522000220 | 10.579002 |
| 67 | 9253229750 | 02.3030.30 | 193 | 9320021000 | 10.4115.00 | 191 | 9522000340 | 10.579004 |
| 67 | 9253231200 | 02.3630.00 | 193 | 9320021010 | 10.4510.00 | 191 | 9522000370 | 10.579003 |
| 67 | 9253239000 | 02.3630.00 | 163 | 9324000002 | 10.R611010 | 191 | 9522002100 | 10.579013 |
| 67 | 9253239810 | 02.3630.30 | 163 | 9324000010 | 10.410107 | 191 | 9522002210 | 10.579005 |
| 67 | 9253240000 | 02.1624.00 | 163 | 9324000020 | 10.410107 | 191 | 9522002220 | 10.579006 |
| 67 | 9253240010 | 02.1624.00 | 163 | 9324000030 | 10.410127 | 192 | 9522010010 | 10.579017 |
| 67 | 9253240070 | 02.1624.00 | 163 | 9324000050 | 10.410107 | 192 | 9522010020 | 10.579016 |
| 67 | 9253240200 | 02.1624.00 | 163 | 9324000060 | 10.410107 | 192 | 9522010030 | 10.579020 |
| 67 | 9253241000 | 02.1624.00 | 163 | 9325000010 | 10.500100 | 192 | 9522010040 | 10.579019 |
| 67 | 9253241020 | 02.1624.00 | 163 | 9325000030 | 10.500200 | 192 | 9522010070 | 10.579018 |
| 67 | 9253241030 | 02.1624.00 | 163 | 9325000040 | 10.500200 | 192 | 9522010080 | 10.579021 |
| 67 | 9253242400 | 02.1624.00 | 163 | 9325000060 | 10.500100 | 93 | 9617010002 | 04.R4212 |
| 67 | 9253248010 | 02.1616.00 | 163 | 9325000070 | 10.500100 | 93 | 9617011000 | 04.4212.00 |
| 67 | 9253249720 | 02.1616.30 | 163 | 9325000130 | 10.500100 | 93 | 9617020010 | 04.4211.10 |
| 67 | 9253249820 | 02.1624.30 | ** | 9325000130 | ZB-4534 | 93 | 9617020040 | 04.4211.10 |
| 67 | 9253249820 | 02.1624.30 | 163 | 9325000140 | 10.500100 | 93 | 9617020060 | 04.4211.10 |
| 67 | 9253252000 | 02.1216.00 | ** | 9325000140 | ZB-4534 | 93 | 9617030002 | 04.R631003 |
| 68 | 9253713070 | 02.2430.80 | ** | 9325000350 | 10.500300 | 93 | 9617030010 | 04.4211.00 |
| 68 | 9253723000 | 02.3030.80 | ** | 9343000020 | 10.4375.20 | 91 | 9617210020 | 04.240.726.23 |
| 68 | 9253723070 | 02.3030.80 | 183 | 9343000030 | 10.4375.10 | 91 | 9617210040 | 04.240.726.21 |
| 68 | 9253760000 | 02.2430.80 | 183 | 9343010000 | 10.8321.00 | ** | 9617210042 | 11.R2928 |
| 67 | 9254201000 | 02.2024.00 | 183 | 9343010002 | 10.R8321 | 96 | 9617210070 | 04.4238.00 |
| 67 | 9254207010 | 02.2024.00 | 194 | 9346020500 | 10.2450.15 | 96 | 9617210082 | 04.R4238 |
| 67 | 9254211000 | 02.2424.00 | 115 | 9347000400 | 06.559160 | 91 | 9617210170 | 04.240.726.22 |
| 67 | 9254214300 | 02.2430.00 | 115 | 9347010000 | 06.645.526 | 91 | 9617210190 | 04.240.726.24 |
| 67 | 9254214310 | 02.2430.00 | 115 | 9347010002 | 06.R639007 | 92 | 9617210210 | 04.240.726.27 |
| 67 | 9254217010 | 02.2424.00 | 115 | 9347020012 | 06.R639008 | 92 | 9617210230 | 04.240.726.28 |
| 67 | 9254217510 | 02.2424.00 | 115 | 9347020020A | | 92 | 9617210270 | 04.240.726.29 |
| 67 | 9254219820 | 02.2424.30 | | 6,3BAR | 06.539110 | 91 | 9617210330 | 04.240.726.21 |
| 67 | 9254222170 | 02.3030.00 | 115 | 9347020052 | 06.R659008 | 91 | 9617210440 | 04.240.726.21 |
| 67 | 9254241000 | 02.1624.00 | 115 | 9347020062 | 06.R639008 | 89 | 9617210500 | 04.240.726.1 |
| 67 | 9254241040 | 02.1624.00 | 115 | 9347020092 | 06.R659008 | 89 | 9617210510 | 04.240.726.3 |
| 69 | 9254248000 | 02.1616.60 | 115 | 9347020400 | 06.539110 | 90 | 9617210520 | 04.240.726.4 |
| 67 | 9254249000 | 02.1616.00 | 115 | 9347021000 | 06.539110 | 89 | 9617210530 | 04.240.726.0 |
| 67 | 9254290010 | 02.2730.00 | 115 | 9347021100A | | 89 | 9617210540 | 04.240.726.1 |
| 67 | 9254290020 | 02.2730.00 | | 7,0BAR | 06.539110 | 91 | 9617211160 | 04.240.726.25 |
| 67 | 9254290610 | 02.2730.00 | 115 | 9347021910 | 06.559120 | 92 | 9617211220 | 04.240.726.26 |
| 67 | 9254300360 | 02.2024.00 | 115 | 9347021920 | 06.559120 | 92 | 9617211250 | 04.240.726.31 |
| 67 | 9254301000 | 02.2024.00 | 115 | 9347022100 | 06.559110 | 96 | 9617220022 | 04.R631008 |
| 67 | 9254320000 | 02.3024.00 | 115 | 9347022210 | 06.559110 | 90 | 9617220032 | 04.R631009 |
| 67 | 9254324060 | 02.3030.00 | 116 | 9347022400 | 06.569110 | 95 | 9617220042 | 04.R631010 |
| 67 | 9254324100 | 02.3030.00 | 115 | 9347022500 | 06.559120 | 96 | 9617221500 | 04.4234.00 |
| 67 | 9254394000 | 02.2730.00 | 116 | 9347022500 | 06.6050.60 | 96 | 9617221510 | 04.4224.00 |
| 67 | 9254394060 | 02.2730.00 | 115 | 9347022600 | 06.559120 | 96 | 9617221520 | 04.4224.50 |
| 67 | 9254500010 | 02.2024.00 | 115 | 9347023200 | 06.539110 | 90 | 9617221580 | Girado |
| 67 | 9254500400 | 02.2020.00 | 115 | 9347023800 | 06.539110 | | pomo boca 22T | 04.565590 |
| 67 | 9254510010 | 02.2424.00 | 115 | 9347023810 | 06.539110 | 97 | 9617221680 | 04.4227.00 |
| 67 | 9254520010 | 02.3030.00 | ** | 9347050010 | AE-4510 | 93 | 9617221700 | 04.4100.00 |
| ** | 9617222100 | 04.4223.00 | | | | | | |
| 95 | 9617222120 | 04.4220.00 | | | | | | |
| 95 | 9617222320 | 04.4228.00 | | | | | | |
| 97 | 9617222520 | 04.4225.00 | | | | | | |
| 96 | 9617222560 | 04.4224.50 | | | | | | |
| 95 | 9617222580 | 04.4219.00 | | | | | | |
| 90 | 9617222580 | 04.565590 | | | | | | |
| 95 | 9617222640 | 04.4221.00 | | | | | | |
| 96 | 9617222690 | 04.4222.00 | | | | | | |
| 95 | 9617222750 | 04.4218.00 | | | | | | |
| 95 | 9617222840 | 04.4218.00 | | | | | | |
| 94 | 9617223050 | 04.4217.00 | | | | | | |
| 97 | 9617223140 | 04.4226.00 | | | | | | |
| 97 | 9617223240 | 04.4226.00 | | | | | | |
| ** | 9617227942 | 04.R565598 | | | | | | |
| 94 | 9617230002 | 04.R4214 | | | | | | |
| 93 | 9617230010 | 04.4213.00 | | | | | | |
| 93 | 9617230012 | 04.R4213 | | | | | | |
| 93 | 9617230040 | 04.4213.00 | | | | | | |
| 94 | 9617230050 C/ Tapón | 04.4215.00 | | | | | | |
| | en boca 22 | | | | | | | |
| 93 | 9617230160 | 04.4213.00 | | | | | | |
| 94 | 9617230190 | 04.4239.00 | | | | | | |
| 93 | 9617230210 | 04.4213.00 | | | | | | |
| 94 | 9617231020 | 04.4214.00 | | | | | | |
| 94 | 9617231040 | 04.4215.00 | | | | | | |
| 97 | 9617231070 | 04.4229.00 | | | | | | |
| 94 | 9617231080 | 04.4214.00 | | | | | | |
| 94 | 9617231110 | 04.4214.00 | | | | | | |
| 94 | 9617231120 | 04.4216.00 | | | | | | |
| 94 | 9617231180 | 04.4216.00 | | | | | | |
| 94 | 9617232030 | 04.4214.00 | | | | | | |
| 94 | 9617232080 | 04.4214.00 | | | | | | |
| 94 | 9617232120 | 04.4214.00 | | | | | | |
| 103 | 9630010010 | 05.2458.49 | | | | | | |
| 104 | 9630010120 A M-16 | 05.2458.51 | | | | | | |
| 104 | 9630010130 | 05.2458.51 | | | | | | |
| ** | 9630010530 | 352.044.001 | | | | | | |
| 104 | 9630060010 | 05.2458.50 | | | | | | |
| 104 | 9630060030 A M-16 | 05.2458.50 | | | | | | |
| 173 | 9640010020 | 10.9640.00 | | | | | | |
| 149 | 9700511020 | 09.051.102 | | | | | | |
| 149 | 9700511070 | 09.051.107 | | | | | | |
| 145 | 9700511110 | 09.051.111 | | | | | | |
| 145 | 9700511110 | 09.3200.00 | | | | | | |
| 146 | 9700511130 | 09.051.131 | | | | | | |
| 141 | 9700511140 | 09.051.114 | | | | | | |
| 149 | 9700511240 | 09.051.124 | | | | | | |
| 144 | 9700511260 | 09.051.126 | | | | | | |
| 146 | 9700511280 | 09.051.128 | | | | | | |
| 141 | 9700511290 | 09.051.129 | | | | | | |
| 146 | 9700511310 | 09.051.131 | | | | | | |
| 145 | 9700511320 | 09.051.132 | | | | | | |
| 145 | 9700511320 | 09.3208.00 | | | | | | |
| 146 | 9700511370 | 09.051.137 | | | | | | |
| 147 | 9700511470 | 09.051.159 | | | | | | |
| ** | 9700511470 | VG-3361 | | | | | | |
| 141 | 9700511500 | 09.051.129 | | | | | | |
| 146 | 9700511510 | 09.051.151 | | | | | | |
| ** | 9700511560 | 09.051.156 | | | | | | |
| 152 | 9700511560 | 09.051.183 | | | | | | |
| ** | 9700511570 | 09.051.157 | | | | | | |
| 147 | 9700511580 | 09.051.158 | | | | | | |
| 147 | 9700511590 | 09.051.159 | | | | | | |



| Pág. WABCO | AIR-FREN |
|-----------------------|---------------|
| ** 9700511590 | VG-3361 |
| 146 9700511620 | 09.051.151 |
| 147 9700511630 | 09.051.164 |
| 147 9700511640 | 09.051.164 |
| 152 9700511650 | 09.051.176 |
| 141 9700511690 | 09.051.129 |
| 152 9700511760 | 09.051.176 |
| 152 9700511770 | 09.051.183 |
| 147 9700511790 | 09.051.179 |
| 146 9700511820 | 09.051.128 |
| 152 9700511830 | 09.051.183 |
| 149 9700511910 | 09.1331.770 |
| 150 9700511920 | 09.655.435 |
| 150 9700511930 | 09.360.717 |
| 151 9700511940 | 09.655.639 |
| 141 9700512050 | 09.051.205 |
| 149 9700512080 | 09.051.209 |
| 149 9700512090 | 09.051.209 |
| 149 9700512090 | 09.627.612 |
| ** 9700512090 | 970.051.209.0 |
| ** 9700512140 | 970.051.214.0 |
| 145 9700513070 | 09.051.307 |
| 145 9700513070 | 09.3261.00 |
| 144 9700513070 | 09.625.436 |
| ** 9700513070 | VG-3261 |
| ** 9700514020 | 970.051.402.0 |
| ** 9700514050 | 970.051.405.0 |
| ** 9700514050 (Susti) | 970.051.431.0 |
| 144 9700514060 | 09.051.406 |
| ** 9700514060 | VG-3262 |
| 148 9700514070 | 09.051.407 |
| ** 9700514120 | 970.051.412.7 |
| 148 9700514130 | 09.051.407 |
| 144 9700514140 | 09.051.414 |
| 145 9700514140 | 09.3261.00 |
| 144 9700514140 | 09.625.436 |
| ** 9700514140 | VG-3261 |
| ** 9700514150 | 970.051.438.0 |
| 148 9700514230 | 09.051.407 |
| 148 9700514240 | 09.051.407 |
| 148 9700514310 | 09.051.431 |
| ** 9700514380 | 970.051.438.0 |
| 145 9700519032 | 09.R051.131 |
| 141 9700519042 | 09.R051.114 |
| 145 9700519052 | 09.R051.111 |
| 143 9700519062 | 09.R051.107 |
| 149 9700519062 | 09.R051.124 |
| 141 9700519072 | 09.R051.205 |
| 149 9700519092 | 09.R051.209 |
| 141 9700519102 | 09.R051.129 |
| 146 9700519102 | 09.R051.137 |
| ** 9700519102 | 09.R051.169 |
| 145 9700519112 | 09.R051.132 |
| 147 9700519162 | 09.R051.158 |
| 204 9700519162 | 11.R2922 |
| 146 9700519172 | 09.R051.151 |
| 145 9700519432 | 09.R051.307 |
| 147 9700519452 | 09.R051.164 |
| ** 9700519492 | 09.R051.405 |
| 207 9700519492 | 11.R2946 |
| 152 9700519502 | 09.R051.176 |
| 144 9700519522 | 09.R051.406 |
| 207 9700519532 | 11.R2945 |
| 147 9700519552 | 09.R051.179 |

| Pág. WABCO | AIR-FREN |
|-----------------------------|--------------------------|
| 147 9700519562 | 09.R051.164 |
| 144 9700519612 | 09.R051.414 |
| 148 9700519742 | 09.R051.431 |
| 147 9701900050 | 09.1605.00 |
| 103 9710020000 | 05.235546 |
| 104 9710020000 | 05.557007 |
| 103 9710020032 | 05.R645010 |
| 102 9710020042 | 05.R9710 |
| 104 9710020062 | 05.R557007 |
| 104 9710020072 | 05.R557007 |
| ** 9710020072 | 11.R0546.6 |
| 108 9710020082 | 05.R557006 |
| 103 9710021500 | 05.235546 |
| 102 9710021510 | 05.9710.00 |
| 102 9710021520 | 05.9710.00 |
| 103 9710021550 | Sin avance 05.235546 |
| 108 97100220000 | 05.557006 |
| 108 9710023000 | 05.557006 |
| 108 9710023010 | Sin avance 05.557006 |
| 103 9710025310 | 05.2750.70 |
| 103 9710025700 | 05.2750.60 |
| 103 9710027010 | 05.2750.70 |
| 101 9730010002 | 05.R645002 |
| 101 9730010100 | 05.545003 |
| 101 9730010200 | 05.135517 |
| 101 9730010300 | 05.545003 |
| 101 9730010310 | Girar tapa 90° 05.545003 |
| 101 9730012110 | 05.545004 |
| 105 9730020000 | 05.557004 |
| 105 9730020032 | 05.R657000 |
| 105 9730020052 | 05.R657002 |
| 105 9730020062 | 05.R657001 |
| 105 9730020070 | 05.557004 |
| 105 9730025200 | 05.557002 |
| 105 9730025210 | 05.557001 |
| 105 9730025220 | 05.557001 |
| 105 9730025240 | 05.557001 |
| 105 9730025350 | 05.557001 |
| 105 9730025390 | 05.557001 |
| ** 9730030000 | 05.3750.00 |
| 102 9730060000 | 05.545023 |
| 102 9730060010 | 05.545021 |
| 102 9730060030 | 05.545022 |
| 105 9730080012 | 05.R008000 |
| 105 9730080020 | 05.008000 |
| 105 9730080050 | 05.009300 |
| 105 9730090000 | 05.009000 |
| 105 9730090002 | 05.R009000 |
| 105 9730090010 | 05.009000 |
| 105 9730090012 | 05.R009300 |
| 105 9730090060 | 05.009000 |
| 105 9730090100 | 05.009010 |
| 105 9730093000 | 05.009300 |
| 101 9730110000 | 05.545004 |
| 101 9730110000 | 05.545005 |
| 101 9730110002 | 05.R5020 |
| 101 9730110010 | 05.545004 |
| 101 9730110020 | 05.545004 |
| 210 9730110022 | 11.R2970 |
| 101 9730110040 C/Silencioso | 10.432407 05.545004 |

| Pág. WABCO | AIR-FREN |
|----------------|------------------------------------|
| 101 9730110100 | 05.545004 |
| 102 9730110500 | 05.545006 |
| 101 9730112000 | 05.545017 |
| 101 9730112050 | Con silencioso 10.432407 05.545017 |
| 178 9735000000 | 10.543002 |
| 178 9735000002 | 10.R3350 |
| 178 9735000380 | 10.543082 |
| 178 9735000470 | Con salidas a 16 10.543002 |
| 179 9750010000 | 10.543012 |
| 179 9750010002 | 10.R543012 |
| 179 9750010020 | 10.543012 |
| 123 9753000002 | 07.R661001 |
| 123 9753001100 | 07.045522 |
| 123 9753001110 | 07.055522 |
| 123 9753001120 | 07.065522 |
| 122 9753030002 | 07.R661003 |
| 121 9753030012 | 07.R661004 |
| 121 9753030600 | 07.561005 |
| 121 9753030610 | 07.561008 |
| 121 9753030720 | 07.561002 |
| 121 9753030810 | 07.561006 |
| 121 9753030830 | 07.561009 |
| 121 9753030840 | 07.7020.80 |
| 122 9753031200 | 07.561011 |
| 122 9753031210 | 07.561011 |
| 122 9753031400 | 07.7020.60 |
| 122 9753032200 | 07.7020.70 |
| 121 9753034460 | 07.7020.90 |
| 121 9753034470 | 07.561007 |
| 121 9753034730 | 07.561001 |
| 121 9753034740 | 07.561002 |
| 121 9753035040 | 07.561009 |
| 195 9753035302 | 10.975.303 |
| 195 9753035312 | 10.975.303.1 |
| 122 9753035410 | 07.561010 |
| 121 9753035780 | 07.7020.90 |
| 121 9753037000 | 07.561008 |
| 90 97617223020 | 04.565590 |

ZF

| Pág. ZF | AIR-FREN |
|----------------|------------|
| 174 0501002209 | 10.1880.10 |
| 141 0501002742 | 09.051.129 |
| 145 0501004074 | 09.051.132 |
| 152 0501004575 | 09.051.176 |
| ** 0501005065 | 09.051.156 |
| 152 0501005065 | 09.051.183 |
| 152 0501005396 | 09.051.176 |
| 152 0501005422 | 09.051.183 |
| 145 0501005830 | 09.051.307 |
| ** 0501005830 | VG-3261 |
| 148 0501005852 | 09.051.407 |
| 152 0501006545 | 09.051.183 |
| 148 0501006570 | 09.051.407 |
| 141 0501202572 | 09.051.114 |
| 169 0501204595 | 10.6300.00 |
| 169 0501204851 | 10.7060.00 |
| 141 0501204975 | 09.051.114 |
| 173 0501206143 | 10.4750.00 |
| 173 0501240089 | 10.0030.02 |